

Errata

Title & Document Type: 5335A Universal Frequency Counter
Temporary Operating & Service Manual

Manual Part Number: 05335-90005

Revision Date: October 1, 1980

HP References in this Manual

This manual may contain references to HP or Hewlett-Packard. Please note that Hewlett-Packard's former test and measurement, semiconductor products and chemical analysis businesses are now part of Agilent Technologies. We have made no changes to this manual copy. The HP XXXX referred to in this document is now the Agilent XXXX. For example, model number HP8648A is now model number Agilent 8648A.

About this Manual

We've added this manual to the Agilent website in an effort to help you support your product. This manual provides the best information we could find. It may be incomplete or contain dated information, and the scan quality may not be ideal. If we find a better copy in the future, we will add it to the Agilent website.

Support for Your Product

Agilent no longer sells or supports this product. You will find any other available product information on the Agilent Test & Measurement website:

www.tm.agilent.com

Search for the model number of this product, and the resulting product page will guide you to any available information. Our service centers may be able to perform calibration if no repair parts are needed, but no other support from Agilent is available.

BBB0

TEMPORARY OPERATING AND SERVICE MANUAL

5335A Universal Frequency Counter

General Information
Installation
Operation and Programming
Operational Verification
Adjustments
Replaceable Parts
Manual Changes
Service

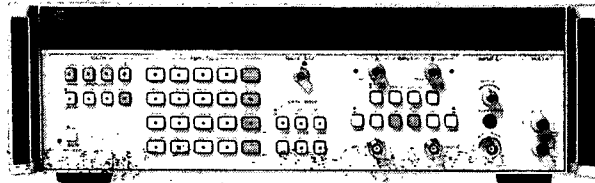

HEWLETT
PACKARD

SAFETY

This product has been designed and tested according to International Safety Requirements. To ensure safe operation and to keep the product safe, the information, cautions, and warnings in this manual must be heeded. Refer to Section I for general safety considerations applicable to this product.

CERTIFICATION

Hewlett-Packard Company certifies that this product met its published specifications at the time of shipment from the factory. Hewlett-Packard further certifies that its calibration measurements are traceable to the United States National Bureau of Standards, to the extent allowed by the Bureau's calibration facility, and to the calibration facilities of other International Standards Organization members.

WARRANTY

This Hewlett-Packard product is warranted against defects in material and workmanship for a period of one year from date of shipment. During the warranty period, Hewlett-Packard Company will, at its option, either repair or replace products which prove to be defective.

For warranty service or repair, this product must be returned to a service facility designated by HP. However, warranty service for products installed by HP and certain other products designated by HP will be performed at Buyer's facility at no charge within the HP service travel area. Outside HP service travel areas, warranty service will be performed at Buyer's facility only upon HP's prior agreement and Buyer shall pay HP's round trip travel expenses.

For products returned to HP for warranty service, Buyer shall prepay shipping charges to HP and HP shall pay shipping charges to return the product to Buyer. However, Buyer shall pay all shipping charges, duties, and taxes for products returned to HP from another country.

LIMITATION OF WARRANTY

The foregoing warranty shall not apply to defects resulting from improper or inadequate maintenance by Buyer, Buyer-supplied software or interfacing, unauthorized modification or misuse, operation outside of the environmental specifications for the product, or improper site preparation or maintenance.

NO OTHER WARRANTY IS EXPRESSED OR IMPLIED. HP SPECIFICALLY DISCLAIMS THE IMPLIED WARRANTIES OF MERCHANTABILITY AND FITNESS FOR A PARTICULAR PURPOSE.

EXCLUSIVE REMEDIES

THE REMEDIES PROVIDED HEREIN ARE BUYER'S SOLE AND EXCLUSIVE REMEDIES. HP SHALL NOT BE LIABLE FOR ANY DIRECT, INDIRECT, SPECIAL, INCIDENTAL, OR CONSEQUENTIAL DAMAGES, WHETHER BASED ON CONTRACT, TORT, OR ANY OTHER LEGAL THEORY.

ASSISTANCE

Product maintenance agreements and other customer assistance agreements are available for Hewlett-Packard products.

For any assistance, contact your nearest Hewlett-Packard Sales and Service Office. Addresses are provided at the back of this manual.

TEMPORARY OPERATING AND SERVICE MANUAL

5335A UNIVERSAL FREQUENCY COUNTER

SERIAL PREFIX: 2024A

This manual applies to Serial Prefix 2024A, unless accompanied by a Manual Change Sheet indicating otherwise.

First Edition — April 1980
Second Edition — October 1980
©Copyright 1980
by
HEWLETT-PACKARD COMPANY
5301 Stevens Creek Blvd.
Santa Clara, CA 95050

All Rights Reserved

*Carole Weber
Paul Stevenson
V.C. Morgan*

MANUAL PART NUMBER 05335-90005

TABLE OF CONTENTS

Section	Title	Page
I	GENERAL INFORMATION	1-1
	1-1. Introduction	1-1
	1-3. Manual Summary	1-1
	1-5. Specifications	1-1
	1-7. Safety Considerations	1-1
	1-9. Instrument Identification	1-5
	1-11. Accessories	1-5
	1-13. Description	1-5
	1-17. Options	1-5
	1-19. Recommended Test Equipment	1-6
II	INSTALLATION	2-1
	2-1. Introduction	2-1
	2-3. Unpacking and Inspection	2-1
	2-5. Preparation for Use	2-1
	2-6. Power Requirements	2-1
	2-8. Line Voltage Selection	2-1
	2-14. Power Cable	2-2
	2-16. Operating Environment	2-3
	2-20. HP-IB Interconnections	2-3
	2-23. 5335A HP-IB Address	2-3
	2-25. HP-IB Descriptions	2-3
	2-27. Field Installation of Options	2-5
	2-29. Field Installation of Option 010	2-5
	2-31. Field Installation of Option 020	2-6
	2-33. Field Installation of Option 030	2-6
	2-36. Storage and Shipment	2-7
	2-37. Environment	2-7
	2-40. Packaging	2-7
III	OPERATION AND PROGRAMMING	3-1
	3-1. Introduction	3-1
	3-3. Operating Characteristics	3-1
	3-6. Local Operation	3-1
	3-9. Remote Operation	3-1
	3-11. Operator's Self-Check Procedure	3-2
	3-13. General Operation Information	3-2
	3-14. Power-Up/Self-Check	3-2
	3-18. Display	3-2
	3-25. Keyboard	3-3
	3-27. Key Indicators	3-3
	3-29. Keyboard Memory	3-3
	3-32. Key Default	3-4
	3-34. Special Function Mode	3-4
	3-37. Front Panel Features	3-5
	3-40. Function Group	3-5
	3-47. Gate/Cycle Group	3-7
	3-55. Input Group	3-8
	3-61. Triggering (MANUAL/AUTO)	3-8
	3-69. Math Group	3-10
	3-78. Statistics Group	3-13
	3-83. Input C (Option 030)	3-14
	3-85. Volts (Option 020)	3-14
	3-87. Rear Panel Features	3-17
	3-93. Detailed Operating Instructions	3-20

TABLE OF CONTENTS (Continued)

Section	Title	Page
III	OPERATION AND PROGRAMMING (Continued)	
3-95.	FREQ A	3-20
3-102.	TIME A → B	3-21
3-109.	TOT A	3-23
3-115.	RATIO A/B	3-24
3-117.	FREQ C	3-24
3-119.	1/TIME A → B	3-24
3-122.	PULSE A	3-25
3-125.	RATIO C/A	3-25
3-127.	PER A	3-25
3-129.	RISE/FALL A	3-25
3-131.	SLEW A	3-26
3-133.	DUTY CYC A	3-26
3-137.	GATE TIME	3-27
3-141.	TRIG LVL	3-27
3-144.	VOLTS	3-27
3-147.	PHASE A rel B	3-28
3-151.	Programming	3-29
3-152.	Introduction	3-29
3-155.	Interface Function	3-30
3-159.	Bus Messages	3-31
3-161.	Address Selection	3-31
3-165.	Device Command Definitions	3-34
3-167.	The 5335A Device Commands	3-35
3-170.	Function Selection FU, FN	3-35
3-172.	Gate Time Setting GA, GO, GC	3-35
3-174.	Remote Display DR \emptyset , DR1, DI	3-38
3-176.	Default States	3-38
3-179.	Initialize	3-38
3-181.	Learn Mode Programming P?, PQ, PB	3-38
3-185.	SRQ and Status SR	3-39
3-189.	Program Execution/Response Times	3-39
3-191.	Output Format	3-40
3-197.	Output Modes	3-41
3-203.	Output of Statistics	3-42
3-206.	Special Functions	3-42
3-209.	Programming Examples	3-43
3-211.	Options	3-56
3-213.	Time Base Option 010	3-56
3-215.	Digital Voltmeter Option 020	3-56
3-217.	C Channel Option 030	3-56
3-219.	Operator's Maintenance	3-56
3-222.	Power/Warm-Up	3-57
3-225.	Operator's Check	3-57
3-229.	Error/Fail Messages	3-58
IV	OPERATIONAL VERIFICATION	4-1
4-1.	Introduction	4-1
4-3.	Local Operational Verification	4-1
4-5.	Equipment Required	4-1
4-7.	Test Record	4-1
4-9.	Error/Fail Messages	4-1
4-11.	HP-IB Verification Program Using the 9825A Controller	4-9

TABLE OF CONTENTS (Continued)

Section	Title	Page
V	ADJUSTMENTS	5-1
	5-1. Introduction	5-1
	5-4. Equipment Required	5-1
	5-6. Factory Selected Components	5-1
	5-8. Adjustment Locations	5-1
	5-10. Safety Considerations	5-1
	5-12. Adjustment Procedures	5-2
	5-13. Power Supply Adjustment Procedure	5-2
	5-15. Input Amplifier Adjustment Procedure	5-2
	5-17. Digital Voltmeter (Option 020) Adjustment Procedure	5-5
	5-19. Channel C Adjustment Procedure	5-5
	5-21. Oscillator Adjustment Procedure (Local and Option 010)	5-8
	5-23. Channel A and B Level Shifter Adjustment Procedure	5-9
VI	REPLACEABLE PARTS	6-1
	6-1. Introduction	6-1
	6-3. Abbreviations	6-1
	6-5. Replaceable Parts	6-1
	6-9. Ordering Information	6-1
	6-12. Direct Mail Order System	6-3
	6-15. Special Considerations for Matched Sets of Components	6-3
VII	MANUAL CHANGES	7-1
	7-1. Introduction	7-1
	7-3. Manual Changes	7-1
	7-6. Older Instruments	7-1
VIII	SERVICE	8-1
	8-1. Introduction	8-1
	8-3. Schematic Diagram Symbols and Reference Designators	8-2
	8-5. Reference Designations	8-2
	8-7. Identification Markings on Printed-Circuit Boards	8-2
	8-11. Assembly Identification	8-2
	8-13. Safety Considerations	8-4
	8-18. Safety Symbols	8-5
	8-20. Recommended Test Equipment	8-5
	8-22. Service Aids	8-5
	8-23. Pozidriv Screwdrivers	8-5
	8-25. Service Aids on Printed Circuit Boards	8-5
	8-27. Factory Selected Components	8-6
	8-29. Procedure to Select R7, R8, R80, or R81 on Amplifier Buffer Assembly, A3	8-6
	8-34. Procedure to Select A3R83 on the Amplifier Buffer Assembly	8-8
	8-35. Procedure to Select A3R29 on the Amplifier Buffer Assembly	8-8
	8-36. Procedure to Select the X10 Compensating Capacitors A3C37 and A3C23	8-9
	8-37. Logic Symbols	8-10
	8-39. Logic Concepts	8-10
	8-41. Negation	8-10
	8-43. Logic Implementation and Polarity Indication	8-11
	8-52. Other Symbols	8-13

TABLE OF CONTENTS (Continued)

Section	Title	Page
VIII	SERVICE (Continued)	
8-54.	Dependency Notation "C" "G" "V" "F"	8-14
8-56.	Control Blocks	8-15
8-58.	Theory of Operation	8-16
8-59.	Overall Counter Operation	8-16
8-64.	Block Diagram Description	8-16
8-65.	Introduction	8-16
8-67.	Microprocessor and MRC	8-16
8-72.	Interpolator Technique	8-18
8-80.	Auto-Triggering and Peak-Detectors	8-20
8-89.	Reading Triggering Levels	8-22
8-92.	Detailed Block Diagram Description	8-23
8-109.	Built-In Diagnostics	8-25
8-110.	Introduction	8-25
8-112.	Accessing the Built-In Diagnostics	8-25
8-116.	Diagnostic #1 "Super Check"	8-26
8-129.	Diagnostic #2: Signature Analysis Stimulus Mode	8-30
8-132.	Diagnostic #3 and #4: Front End Latch Control Test	8-30
8-136.	Diagnostic #5: Front End Switch Test	8-32
8-140.	Diagnostic #6: Rear Panel Arm-Slope Switch Test	8-34
8-143.	Diagnostic #7: HP-IB Switch Status	8-34
8-146.	Diagnostic #9: MRC Short Test	8-37
8-148.	Diagnostic #10: MRC Extended Test	8-37
8-150.	Diagnostic #11, #12, and #13: Interpolator Counters Test	8-37
8-155.	Diagnostic #14: Front End Check	8-37
8-157.	Diagnostic #15: Front Panel Display Test	8-41
8-159.	Diagnostic #16: HP-IB Address Switch	8-41
8-161.	Diagnostic #17: Keyboard Check	8-41
8-163.	Diagnostic #18 and #19: DAC Adjustment (Option 040)	8-43
8-167.	Diagnostic #20, #21 and #22: DVM Reference Test (Option 020)	8-43
8-170.	Diagnostic #23, #24 and #25: DVM Range Test (Option 020)	8-43
8-172.	Diagnostic #26, #27 and #28: Trigger Level DVM Reference Test	8-46
8-174.	Diagnostic #29 and #30: Trigger Levels A and B Test	8-46
8-176.	Diagnostic #31, #32, #33: A4 DVM Power Supplies Test	8-46
8-178.	Diagnostic #34: Incremental Testing of the DAC's (Option 040)	8-46

LIST OF TABLES

Table	Title	Page
1-1.	Specifications	1-2
1-2.	Equipment Supplied	1-5
1-3.	Accessories Available	1-5
1-4.	Recommended Test Equipment	1-6
2-1.	Field Installable Options	2-5
3-1.	Function Key Use During Number Entry	3-11
3-2.	Function Key Reference Summary	3-29
3-3.	HP-IB Interface Capability	3-30
3-4.	5335A Bus Message Usage	3-32
3-5.	HP-IB Address Switch Selections	3-33
3-6.	5335A Device Commands	3-36
3-7.	Status Bits Usage with SRQ	3-39
3-8.	HP-IB Response Times	3-40
3-9.	Error Messages	3-59
3-10.	Fail Messages	3-59
4-1.	Local Operational Verification	4-2
4-2.	Error Messages	4-8
4-3.	Fail Messages	4-8
4-4.	HP-IB Verification	4-10
4-5.	9825A Program Printout	4-11
4-6.	HP-IB Verification Program Listing	4-23
4-7.	Operational Verification Record	4-27a
5-1.	Adjustments	5-2
6-1.	Abbreviations and Reference Designations	6-2
6-2.	Replaceable Parts	6-5
6-3.	Option 010 Replaceable Parts	6-20
6-4.	Option 020 Replaceable Parts	6-21
6-5.	Option 030 Replaceable Parts	6-23
6-6.	Manufacturers Code List	6-25
7-1.	Manual Backdating	7-1
8-1.	Assembly Identification	8-2
8-2.	Selecting R7, R8, R80, or R81	8-6
8-3.	Overall Troubleshooting	8-48
8-4.	Power Supply Test	8-53
8-5.	Timebase and Microprocessor Oscillator Tests	8-54
8-6.	Signature Analysis of the Microprocessor	8-56
8-7.	Signature Analysis of the ROMS	8-58
8-8.	Signature Analysis of the Output Ports	8-59
8-9.	Troubleshooting of the Interpolators	8-61
8-10.	Diagnostics	8-64

LIST OF FIGURES

Figure	Title	Page
1-1.	Model 5335A Universal Counter with Options 020 and 030 and Accessories Supplied	1-0
2-1.	Line Voltage Selection	2-2
2-2.	Power Cable HP Part Numbers versus Mains Plugs Available	2-2
2-3.	Hewlett-Packard Interface Bus Connections	2-4
2-4.	Details of Input Connector J1 and Fuse Mounting	2-7
3-1.	Front Panel Features	3-15
3-2.	Rear Panel Features	3-16
3-3.	Arming Modes	3-18
3-4.	Details of Input Connector J1 and Fuse Mounting	3-57
3-5.	5335A Operating Instructions Label	3-60
4-1.	Front End Switch Test Display	4-4
4-2.	Rear Arm Switch Test Display	4-6
4-3.	Keyboard Check Key Assignments	4-6
4-4.	HP-IB Verification Set-Up	4-9
5-1.	Input Amplifier Adjustment Setup	5-3
5-2.	Input Amplifier Adjust Waveform	5-4
5-3.	Channel C Sensitivity Setup	5-6
5-4.	Oscillator Adjustment Setup	5-7
5-5.	Level Shifter Adjustment Set-Up	5-8
6-1.	Top Internal View	6-26
8-1.	Schematic Diagram Notes	8-3
8-2.	Simplified Block Diagram	8-17
8-3.	Troubleshooting Flowchart	8-27
8-4.	Diagnostic 01	8-29
8-5.	Diagnostic 02	8-31
8-6.	Diagnostic 05	8-33
8-7.	Diagnostic 06	8-35
8-8.	Diagnostics 07 and 16	8-36
8-9.	Diagnostics 09 and 10	8-38
8-10.	Diagnostics 11, 12 and 13	8-39
8-11.	Diagnostic 14	8-40
8-12.	Diagnostics 15 and 17	8-42
8-13.	Diagnostics 18 and 19	8-44
8-14.	Diagnostics 20 through 25	8-45
8-15.	Diagnostics 26 through 33	8-47
8-16.	Power Up Self-Check	8-49
8-17.	Diagnostic 01 Flowchart	8-52
8-18.	10 MHz Timebase Oscillator Signal	8-54
8-19.	4 MHz Microprocessor Oscillator Signal	8-54
8-20.	1 MHz Microprocessor Oscillator Signal	8-55
8-21.	Detailed Block Diagram	8-65
8-22.	Assembly and Cable Locator	8-67
8-23.	A1 Power Supply Assembly and A13 Line Module	8-69
8-24.	A2 Amplifier Support Assembly	8-71
8-25.	A3 Amplifier Buffer Assembly	8-73
8-26.	A4 Main Logic Assembly	8-75

LIST OF FIGURES (Continued)

Figure	Title	Page
8-27.	A5 Keyboard and Display Assembly	8-77
8-28.	A6 Rear Panel Assembly	8-79
8-29.	A7 HP-IB Logic Assembly and A14 HP-IB Connector Assembly	8-81
8-30.	A8 DVM Assembly	8-83
8-31.	A9 Channel C Assembly	8-85
8-32.	A15 10 MHz Oscillator (Model 10544A) Option 010	8-87

PREFACE

This manual is designed to present the information required by the user to effectively operate and maintain the 5335A Universal Counter.

It is divided into sections, each relating to a specific topic. As much as possible the sections are self-contained. It is the intention of this manual to allow for the quick location of desired information, while still providing the overall depth of detail required. Some sections provide the learning and working information, and will be used frequently. Other sections are dedicated to general and introductory types of information, and are intended to be used only for reference. Where applicable, photos, illustrations, and diagrams foldout allowing the user access to related information throughout the manual.

In limiting the depth of coverage in this manual, a certain amount of previous knowledge on the part of the reader must be assumed. A variety of additional related documentation is available. These materials address in depth the specific areas of interest, and should be used, whenever necessary, to supplement this manual. Users unfamiliar with HP-IB or Logic Symbology, for example, may want to refer to the 5335A Documentation Map to find additional sources of information.

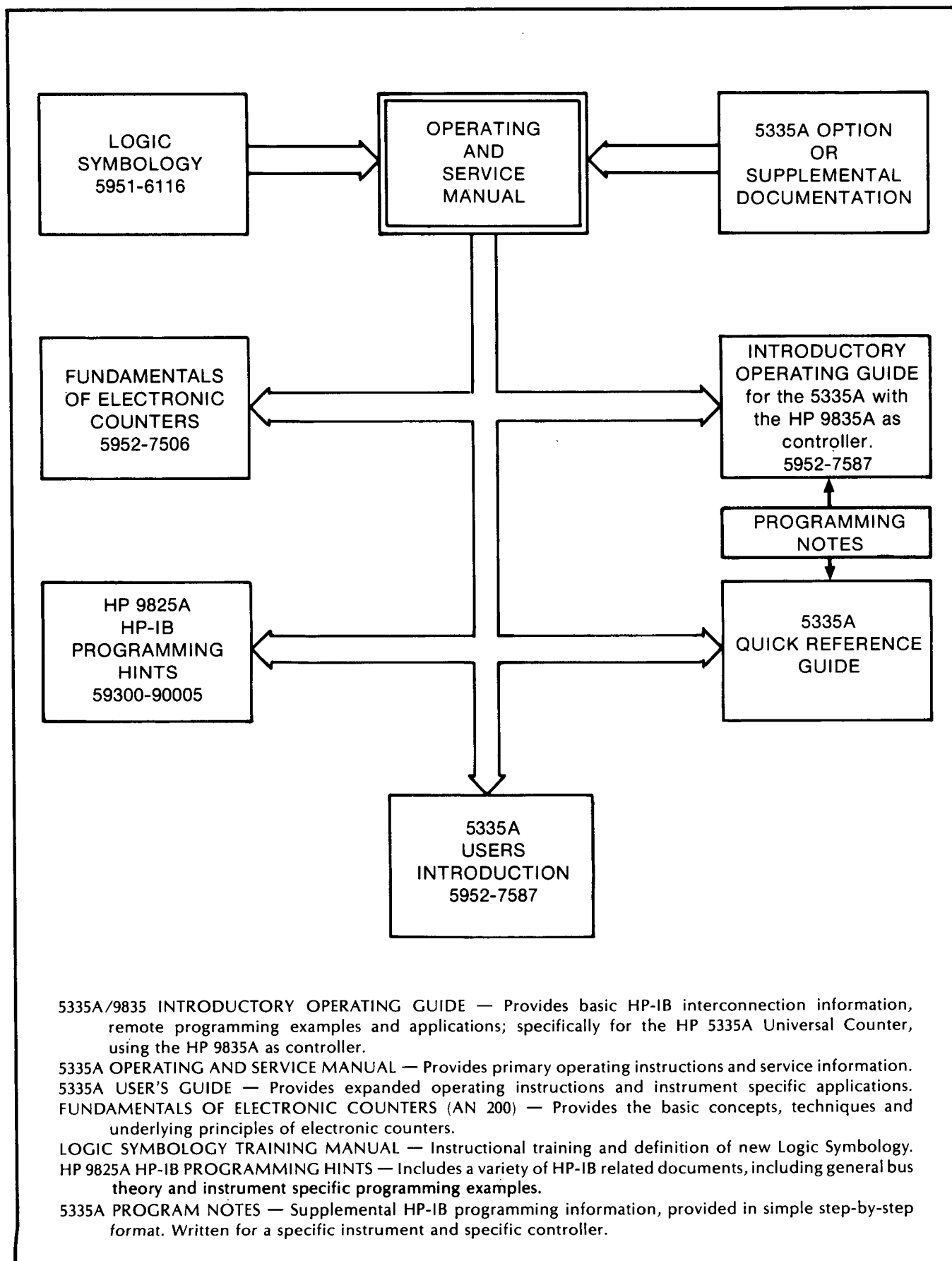

Model 5335A
General Information

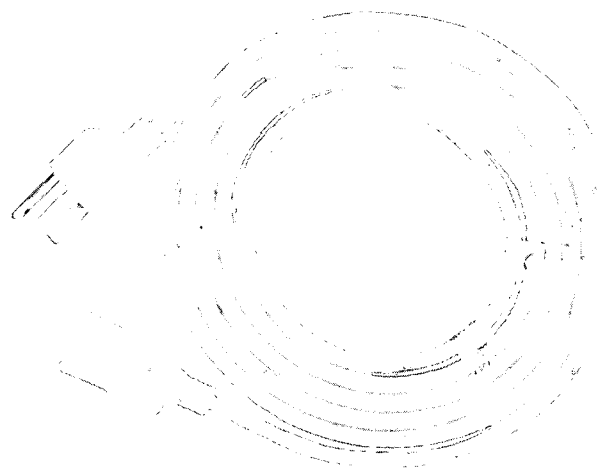
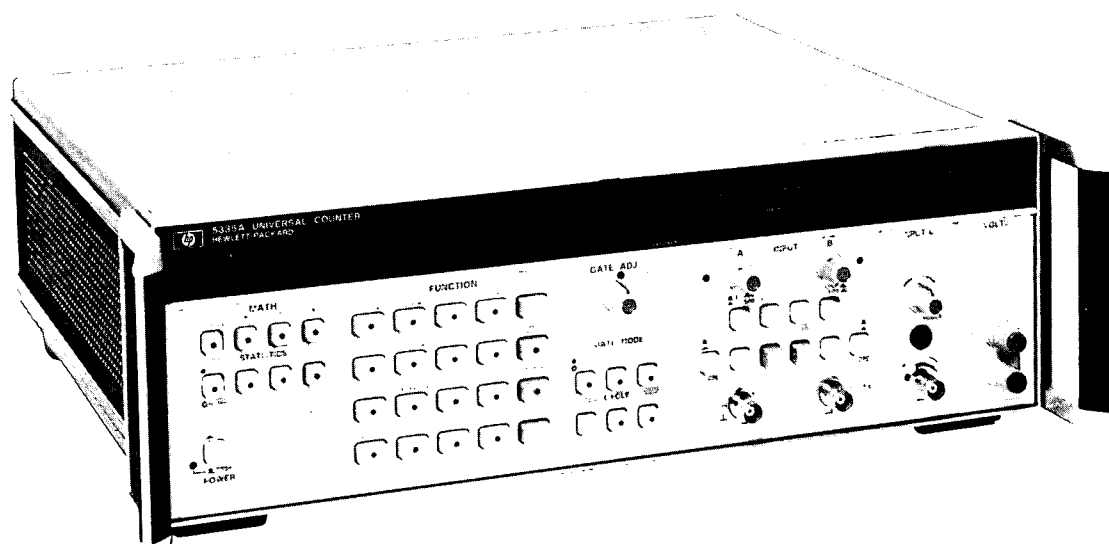

Figure 1-1. Model 5335A Universal Counter with Options 020 and 030 and Accessories Supplied

SECTION I GENERAL INFORMATION

1-1. INTRODUCTION

1-2. This Operating and Service Manual contains the information required to install, operate, test, adjust, and service the Hewlett-Packard Model 5335A Universal Frequency Counter. The counter, with DVM Option 020 and C Channel Option 030, is shown in *Figure 1-1* with its supplied accessories.

1-3. MANUAL SUMMARY

1-4. This manual is divided into eight sections, each covering a particular topic for the operation and service of the HP 5335A. The topics by section number are:

SECTION I, GENERAL INFORMATION. Provides the instrument specifications, instrument identification, description of options, accessories and recommended test equipment.

SECTION II, INSTALLATION. Provides information about initial inspection, preparation for use, storage and shipment, field installation of options, and HP-IB interconnections.

SECTION III, OPERATION AND PROGRAMMING. Provides information about operating characteristics, panel features, local and remote operating instructions, operator's maintenance, and programming. The operation of Options 020 and 030 is included in this section.

SECTION IV, OPERATIONAL VERIFICATION. Provides abbreviated procedures for operational verification which give the operator a high degree of confidence that the 5335A is operating properly.

SECTION V, ADJUSTMENTS. Provides the procedures and adjustment locations required to properly maintain the instrument operating characteristics within specifications.

SECTION VI, REPLACEABLE PARTS. Provides ordering information for all replaceable parts and assemblies within the instrument.

SECTION VII, MANUAL CHANGES. This section is reserved for manual change information which effectively "backdates" the technical areas of the manual to apply to older instruments.

SECTION VIII, SERVICE. This section provides the instrument theory of operation, troubleshooting information, repair techniques, and schematic diagrams.

1-5. SPECIFICATIONS

1-6. The instrument specifications are listed in Table 1-1. These specifications are the performance standards or limits against which the instrument may be tested.

1-7. SAFETY CONSIDERATIONS

1-8. The 5335A Universal Counter is a Safety Class I instrument (provided with a protective earth terminal), designed according to international safety standards. This operating and service manual contains information, cautions, and warnings which must be followed by the user to ensure safe operation and keep the instrument in safe condition.

Table 1-1. Specifications

**INPUT CHARACTERISTICS
(Channel A and B)**

Range:
DC coupled, 0 to 100 MHz.
AC 1 M Ω , 30 Hz to 100 MHz.
AC 50 Ω , 200 KHz to 100 MHz.
NOTE: Channel A range 200 MHz when in Frequency A and Ratio modes.

Sensitivity (X1):
25 mV rms sine wave.
75 mV peak-to-peak pulse at minimum pulse width of 5 ns.

Dynamic Range (X1):
75 mV to 5V peak-to-peak, to 100 MHz.
75 mV to 2.5V peak-to-peak, > 100 MHz.

Signal Operating Range (X1, DC):
-5V dc to +5V dc.

Crosstalk (X1): < 500 mV rms, 0 to 100 MHz, or < 250 mV rms, 100 to 200 MHz, sine wave in either channel will not affect other channel.

Trigger Level Range (X1):
Auto Trigger OFF:
Preset: Set to OV dc NOMINAL.
Adjustable: -5V dc to +5V dc.
Auto Trigger ON:
Preset: Set to NOMINAL 50% point of input signal.
Adjustable: NOMINALLY between + and - peaks of input signal.

Auto Trigger (X1):
Range (50% duty cycle):
DC coupled, 30 Hz to 200 MHz.
AC 1 M Ω , 30 Hz to 200 MHz.
AC 50 Ω , 200 kHz to 200 MHz.
Minimum Signal: 100 mV rms.
Duty Cycle Range: 10% to 90%.
Response Time: 3 seconds TYPICAL.
NOTE: Auto Trigger requires a repetitive signal.

Coupling: AC or DC, switchable.
Impedance: 1 M Ω NOMINAL shunted by < 35 pf, or 50 Ω NOMINAL, switchable. In COMMON A, 1 M Ω is shunted by < 50 pf.
Attenuator: X1 or X10 NOMINAL, switchable.
Slope: Independent selection of + or - slope.
Channel Input: SEPARATE or COMMON A, switchable.

Damage Level (AC or DC):
1 M Ω X 1:
DC to 2 kHz 250V (DC+AC rms)
2 to 100 kHz (5 X 10⁶V rms Hz)/FREQ
> 100 kHz 5V rms
1 M Ω X 10:
DC to 20 kHz 250V (DC + AC rms)
20 to 100 kHz ... (5 X 10⁶V rms Hz)/FREQ
> 100 kHz 50V rms
50 Ω :
DC to 200 MHz 5V rms

FREQUENCY A

Range: 0 to 200 MHz, prescaled by 2.
LSD Displayed:**
 $\frac{1 \text{ ns}}{\text{Gate Time}} \times \text{FREQ.}$ (e.g., 9 digits in a second)
Resolution:
 $\pm (2 \times \text{LSD}) \pm 1.4 \times \frac{\text{Trigger Error}^{**}}{\text{Gate Time}} \times \text{FREQ.}$
Accuracy: $\pm (\text{Resolution}) \pm (\text{Time Base Error}) \times \text{FREQ.}$

PERIOD A

Range: 10 ns to 10⁷s.
LSD Displayed:**
 $\frac{1 \text{ ns}}{\text{Gate Time}} \times \text{PER.}$ (e.g., 9 digits in a second)
Resolution:
 $\pm (2 \times \text{LSD}) \pm 1.4 \times \frac{\text{Trigger Error}^{**}}{\text{Gate Time}} \times \text{PER.}$
Accuracy: $\pm (\text{Resolution}) \pm (\text{Time Base Error}) \times \text{PER.}$
Period Average: User selects MEAN function, and n = 100, or n = 1,000.

TIME INTERVAL A--B

Range: 0 ns to 10⁷s.
LSD Displayed:** 1 ns (100 ps using MEAN).
Resolution: $\pm (2 \times \text{LSD}) \pm (\text{START Trigger Error}^{**}) \pm (\text{STOP Trigger Error}^{**})$
Accuracy: $\pm (\text{Resolution}) \pm (\text{Time Base Error}) \times \text{TI} \pm (\text{Trigger Level Timing Error}^{**}) \pm (2 \text{ ns})$
Gate Mode: MIN only.
Time Interval Average: User selects MEAN function, and n = 100, or n = 1,000.

TIME INTERVAL DELAY (Holdoff)

For Time A--B, 1/Time A--B, Pulse A, (Time B--A, Pulse B), front panel Gate Adjust control inserts a variable delay between START and enabling of STOP. Electrical inputs during delay are ignored. Delay ranges are same as gate time ranges (100 μ s to 4s NOMINAL) for gate modes of Fast, Norm, and Manual. Delay measured by pressing Gate Time key. All other specifications are same as Time Interval A--B.

INVERSE TIME INTERVAL A--B

Range: 10⁷ to 10⁹ units/second.
LSD Displayed, Resolution, and Accuracy are inverse of Time Interval A--B specifications. If Time Interval A--B is zero, display will be zero.

RISE AND FALL TIME A

Range: 20 ns to 10 ms transitions with 50 Hz to 25 MHz repetition rates (50% duty cycle).
Minimum Pulse Height: 500 mV peak-to-peak.
Minimum Pulse Width: 20 ns.
Duty Cycle Range: 20% to 80%.
LSD Displayed and Resolution are same as Time Interval A--B specifications.
Accuracy: $\pm (\text{TI Accuracy}) \pm (\text{Trigger Level Setting Error}^{**} \text{ at } 10\% \text{ point}) \pm (\text{Trigger Level Setting Error}^{**} \text{ at } 90\% \text{ point})$.

Input Mode: Automatically set to COMMON A with 10% and 90% trigger levels.
Gate Mode: MIN only.

PULSE WIDTH A

Range: 5 ns to 10⁷s.
Trigger Point Range: 40% to 60% of pulse height.
LSD Displayed and Resolution are same as Time Interval A--B specifications.
Accuracy: $\pm (\text{Resolution}) \pm (\text{Time Base Error}) \times \text{PULSE} \pm (\text{Trigger Level Timing Error}^{**}) \pm 2 \text{ ns.}$

DUTY CYCLE A**

Range: 1% to 99%, 0 to 100 MHz.
Trigger Point Range: 40% to 60% of pulse height.
LSD Displayed:**
 $\frac{1 \text{ ns}}{\text{PER}} \times 100\%$
Resolution:
 $\pm \left(\frac{\text{PULSE} + |\text{PULSE Resolution}|}{\text{PER} - |\text{PER Resolution}|} \right) \times 100\%$
- DUTY CY).
Accuracy:
 $\pm \left(\frac{\text{PULSE} + |\text{PULSE Accuracy}|}{\text{PER} - |\text{PER Accuracy}|} \right) \times 100\%$
- DUTY CY).
Gate Mode: MIN only.
NOTE: Constant duty cycle required during measurement.

SLEW RATE A**

Range: 50 V/s to 10⁸ V/s slew rate with 50 Hz to 25 MHz repetition rates (50% duty cycle).
Minimum Pulse Height, Width, and Duty Cycle Range are same as Rise and Fall Time A.
LSD Displayed:**
 $\frac{1 \text{ ns}}{|\text{RISE/FALL}|} \times \text{SLEW;}$ three digits maximum.
Resolution:
 $\pm \left(\frac{|\text{TRIG LVL B} - \text{TRIG LVL A}| + 20 \text{ mV}}{|\text{RISE/FALL}| - |\text{RISE/FALL Resolution}|} \right) - |\text{SLEW}|$
Accuracy:
 $\pm \left(\frac{|\text{TRIG LVL B} - \text{TRIG LVL A}| \times 1.003 + 40 \text{ mV}}{|\text{RISE/FALL}| - |\text{RISE/FALL Accuracy}|} \right) - |\text{SLEW}|$
Input Mode: Automatically set to COMMON A with 10% and 90% trigger levels.
Gate Mode: MIN only.

RATIO A/B

Range:
Channel A, 0 to 200 MHz (prescaled by 2).
Channel B, 0 to 100 MHz.
LSD Displayed:**
 $\frac{\text{RATIO}}{\text{FREQ} \times \text{Gate Time}}$

where FREQ is higher frequency after prescaling.
Resolution:
 $\pm \text{LSD} \pm \frac{\text{Trigger Error}}{\text{Gate Time}} \times \text{RATIO}$
where Trigger Error is on lower frequency after prescaling.
Accuracy: Same as Resolution.

TOTALIZE A

Range: 0 to 100 MHz.
LSD Displayed:** 1 count of input
HP-IB Output: At end of gate.
Manual:
Count Reset: Via RESET key.
HP-IB Output: Totalize data on-the-fly sent if Cycle mode set to Single. Input frequency range in this mode is 0 to 50 Hz NOMINAL.
Gate:
Count Reset: Automatic after measurement.
Resolution: $\pm \text{LSD}$
Accuracy: Same as Resolution.

*Specifications describe the instrument's warranted performance. Supplemental characteristics are intended to provide information useful in applying the instrument by giving TYPICAL or NOMINAL, but nonwarranted performance parameters. Definition of terms is provided at the end of the specification section. For a more detailed explanation, see Application Note 200.4 "Understanding Frequency Counter Specifications".

**See Definitions section for further information.

Table 1-1. Specifications (Continued)

PHASE A rel B**

Range: -180° to 360°, Range Hold off, or 0° to 360°, Range Hold on, with signal repetition rates of 30 Hz to 1 MHz.

Minimum Signal: 100 mV rms.

LSD Displayed:** 0.1°.

Resolution:

$$\pm \left[\frac{T_{11} + (T_{11} \text{ Resolution}) + T_{12} + (T_{12} \text{ Resolution})}{2 [\text{PER A} - |\text{PER A Resolution}|]} \right] \times 360^\circ$$

- PHASE (expressed in + degrees)

Input Mode: Automatically set to 50% trigger level in A and B channels.

Gate Mode: MIN only.

NOTE: Constant phase required during measurement.

Accuracy:

$$\text{Resolution} + \left[\frac{(T_{11} + T_{11} \text{ error}) + (T_{12} + T_{12} \text{ error})}{2 (\text{PER} + \text{PER}_{\text{error}})} \right] \times 360^\circ$$

- PHASE (expressed in - degrees)

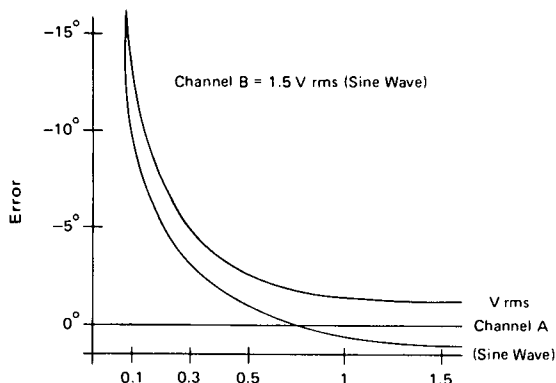

Typical phase uncertainty for PHASE A rel B measurements where channel B is 1.5 V RMS and channel A is varied in amplitude

NOTE: When signal B is smaller than signal A phase measurement uncertainty tends to be positive. T_{11} and T_{12} are times between 50% points of A and B as illustrated in the DEFINITIONS section.

T_{11} error and T_{12} error are the errors due to: 1) Trigger Level Timing Error, 2) Trigger Level Setting Error, and 3) Trigger Error due to noise.

**HEWLETT-PACKARD
INTERFACE BUS**

Programmable Controls: All measurement functions, Math, Statistics, Reset, Range Hold, Ext. Arm Enable/Slope, Check, Gate Adj. (~1 ms to 1s), Gate Open/Close (gate times to ∞), Gate Mode, Cycle, Preset, Slope, Common A, Auto Trigger.

Special Functions: **FREQ B, PULSE B, TIME B--A, TOT A-B, LEARN, MIN, MAX**, all internal diagnostic routines.

HP-IB Commands: Trigger, Clear, Remote, Local, Local Lockout, Require Service.

Data Output Rate: Fixed output format consisting of 19 characters plus CR and LF output in TYPICALLY 8 ms. Number of readings second dependent on function, gate, and cycle used (~15 readings second maximum).

GENERAL

Function Memory: Front panel settings for Math, Statistics, Range Hold, Ext. Arm Enable, Gate, and Cycle stored for current function and immediately preceding function. GATE TIME and TRIG LVL do not affect memory.

Gate: Minimum, manual, or continuously variable (NORM/FAST) via Gate Adj. control.

NORM: 20 ms to 4s NOMINAL.

FAST: 100 μs to 20 ms NOMINAL.

MIN: Minimum gate time. Actual time depends on function. For FREQ A, (FREQ B), FREQ C, and PER A, minimum gate = (one period of input) × (prescale factor).

MANUAL: Each press opens or closes gate.

Cycle: Determines delay between measurements. **NORM:** No more than 4 readings per second NOMINAL.

MIN: Updates display as rapidly as possible (~15 readings per second, depending on function).

SINGLE: One measurement taken with each press of button.

Arming: Ext. Arm Enable key allows rear panel input to determine Start and/or Stop point of a measurement. External gate defined by both Start and Stop armed. All measurements are armable except Manual Totalize, Phase, and Trigger Level.

Start Arm: + or - slope of arm input signal starts measurement.

Stop Arm: + or - slope of arm input signal stops measurement. When used, Start arm must occur before Stop arm.

Ext. Arm Input: Rear panel BNC accepts TTL into 20 kΩ.

Minimum Start to Stop Time: 200 ns.

Trigger Level Out: DC output into 1 MΩ via rear panel BNC's for Channel A and B; not adjusted for attenuators.

Accuracy at DC (X1): ± 15 mV ± 0.5% of TRIG LVL reading.

Gate Out: TTL level into 1 kΩ; goes low when gate open; rear panel BNC.

Range Hold: Freezes decimal point and exponent of display.

Reset: Starts a new measurement cycle when pressed.

Check: Performs internal self test and lamp test.

Display: 12 digit LED display in engineering format; exponent range of +18 to -18.

Overflow: All measurements which would theoretically cause a display of more than 12 digits will display 12 most significant digits.

Operating Temperature: 0 to 50°C.

Power Requirements: 100, 120, 220, 240 VAC (+5%, -10%), 48-66 Hz; 130 VA max.

Weight: Net, 8.8 kg (19 lbs. 8 oz.); shipping, 13.6 kg (30 lbs.).

Dimensions: 425.5 mm W × 132.6 mm H × 345.4 mm D (16 1/4" × 5 1/4" × 13 1/2"), not including removable handles.

GATE TIME

Range: 100 ns to 10⁷s.

LSD Displayed:** Up to three digits with Ext. Arm Enable OFF, 100 ns when ON. MIN Gate Mode display zero.

NOTE: Time displayed and actual gate time may differ due to input signal synchronization of gate.

TRIGGER LEVEL

Range: X1, +5 to -5 volts.
X10, +50 to -50 volts.

Resolution: X1, 10 mV; X10, 100 mV.

Accuracy (X1): ± 20 mV, ± 0.5% of reading.

NOTE: Reading is center point of hysteresis band. When in X10, reading is multiplied by 10.

TIME BASE

Standard Crystal:

Frequency: 10 MHz.

Aging Rate: < 3 × 10⁻⁷/month.

Temperature: < 4 × 10⁻⁶, 0 to 50°C.

Line Voltage: < 1 × 10⁻⁷ for 10% change.

High Stability Crystal: See Option 010.

External Time Base Input: Rear panel BNC accepts 5 or 10 MHz, 200 mV rms into 1 kΩ; 5V rms maximum.

Time Base Out: 10 MHz, >1V p-p into 50 Ω via rear panel.

STATISTICS

Sample Size: Selectable between either N = 100 or N = 1000 samples.

Std. Dev.: Displays a standard deviation of selected sample size.

Mean: Displays mean estimate of selected sample size.

Smooth: Performs a weighted running average and truncates unstable least significant digits from display.

NOTE: Statistics functions performed after Math functions.

MATH

All measurement functions, with exception of GATE TIME and TRIG LVL, may be operated upon by Math functions. Offset, Normalize, and Scale may be used independently or together as follows:

$$\text{Display} = \frac{\text{Measurement} + \text{Offset}}{\text{Normalize}} \times \text{Scale.}$$

Numbers are entered via blue labeled keys.

DISABLE key will toggle off and on all active math keys.

Number Value Range: ±1 × 10⁻⁹ to ±9 × 10⁹.

Last Display: Causes value of previous display to Offset (negative value), Normalize, or Scale all subsequent measurements.

Measurement t-1: Causes each new measurement to be Offset (negative value), Normalized, or Scaled by each immediately preceding measurement.

**See Definitions section for further information.

Table 1-1. Specifications (Continued)

OPTIONS

Option 010: High Stability Time Base (Oven)
Frequency: 10 MHz.
Aging Rate: $< 5 \times 10^{-10}$ /day after 24 hr. warm up.
Short Term: $< 1 \times 10^{-10}$ rms for 1s average.
Temperature: $< 7 \times 10^{-9}$, 0 to 50°C.
Line Voltage: $< 1 \times 10^{-10}$ for 10% change.
Warm-Up: Within 5×10^{-9} of final value in 20 min.

Option 020: DC Digital Voltmeter
Range: 4 digits, autoranging, autopolarity, in $\pm 10, \pm 100, \pm 1000$ V ranges.
Sensitivity: 100 μ V, 1 mV, 10 mV, 100 mV for $\pm 1V, \pm 10V, \pm 100V, \pm 1000V$ readings.
LSD Displayed:** Same as sensitivity.
Accuracy (10 min. warm-up): $\pm 0.045\%$ of reading $\pm 0.02\%$ of range; for 1000V range, $\pm 0.06\%$ of reading $\pm 0.02\%$ of range. For 60 days at 24°C $\pm 5^\circ$ C, RH $< 80\%$, and gate > 100 ms.
Temperature Coefficient: $\pm (0.0055\%$ of reading $+ 0.005\%$ of range)/°C; for 1000V range, $\pm (0.008\%$ of reading $+ 0.0005\%$ of range)/°C.

Input Type: Floating pair.
Input Impedance: 10 M $\Omega \pm 1\%$.
Maximum Input: Hi to Lo, $\pm 1000V$ all ranges. Lo to chassis ground, $\pm 500V$.
Response Time: 100 ms to within 1% of final value, within one range.
Normal Mode Rejection: 30 dB at 50/60 Hz.
Effective Common Mode Rejection (1 k Ω unbalanced): ≥ 110 dB at 50/60 Hz.
Filter: Single pole from 10 Hz NOMINAL.

Dynamic Range:
 10 mV to 1 V rms (40 dB), to 1 GHz.
 100 mV to 1 V rms (20 dB), to 1.3 GHz.
Signal Operating Range: +5V dc to -5V dc.
Coupling: AC.
Impedance: 50 Ω NOMINAL (VSWR, $< 2.5:1$ TYPICAL).
Damage Level: $\pm 8V$ (DC + AC peak), fuse protected. Fuse located in BNC connector.

Option 030: 1.3 GHz C Channel
Input Characteristics
Range: 150 MHz to 1.3 GHz, prescaled by 20.
Sensitivity:
 10 mV rms sine wave (-27 dBm) to 1 GHz.
 100 mV rms sine wave (-7 dBm) to 1.3 GHz.
 Sensitivity can be decreased continuously by up to 20 dB NOMINAL, 150 to 1000 MHz and 14 dB NOMINAL, 1 to 1.3 GHz via sensitivity control. Trigger level is fixed at 0V NOMINAL.

Frequency C
Range: 150 MHz to 1.3 GHz, prescaled by 20.
LSD Displayed, Resolution, and Accuracy** are same as Frequency A.

Ratio C/A
Range:
 Channel A, 0 to 200 MHz (prescaled by 2).
 Channel C, 150 to 1300 MHz (prescaled by 20).
LSD Displayed, Resolution, and Accuracy** are same as Ratio A/B.

DEFINITIONS

LSD Displayed; Unit value of Least Significant Digit displayed. Calculations should be rounded up to nearest decade, with a 12 digit mantissa maximum. If truncation required, most significant digits are kept.

Trigger Error:

$$\frac{\sqrt{(260 \mu V)^2 + e_n^2}}{\text{Input slew rate at trigger point}} \text{ rms typical}$$

where e_n is the rms noise voltage of the input for a 200 MHz bandwidth.

Trigger Level and Trigger Point (X1):

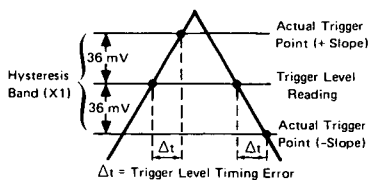

Trigger Level Timing Error (X1): Applies to Time Interval measurements;

$$\frac{36 \text{ mV}}{|\text{Input slew rate at START trigger point}|}$$

$$- \frac{36 \text{ mV}}{|\text{Input slew rate at STOP trigger point}|}$$

Trigger Level Setting Error (X1): Applies to Rise/Fall, Slew, and Phase measurements:

$$\pm 2\% \text{ of input p-p voltage} \pm 40 \text{ mV}$$

Input slew rate at trigger point

Duty Cycle: Percentage of time a signal is high or low, depending on Slope A setting. Trigger point is high/low dividing point.

$$\text{DUTY CY} = \frac{\text{PULSE}}{\text{PER}} \times 100\%;$$

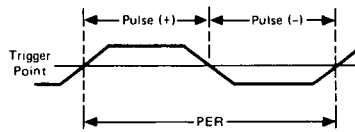

Slew Rate: Effective slope between 10% and 90% points of rising or falling signal depending on Slope A setting.

$$\text{SLEW} = \frac{V_B - V_A}{T_I};$$

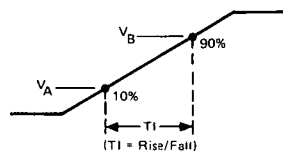

Phase: Angle, with respect to B signal, between 50% points of Channel A and B signals, trigger slopes selected by Channel A and B slope switches.

$$\text{PHASE} = \frac{T_{I1} + T_{I2}}{\text{PER}} \times 360^\circ;$$

T_{I1} is time between 50% points of A then B signals using slopes defined during Phase measurement.

T_{I2} is time between 50% points of A then B signals using complement slopes to T_{I1} .

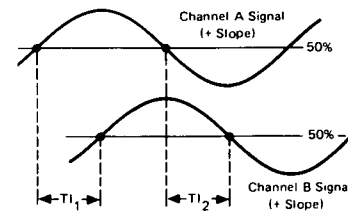

1-9. INSTRUMENT IDENTIFICATION

1-10. Hewlett-Packard instruments have a 2-section, 10-character serial number (0000A00000), which is located on the rear panel. The four-digit serial prefix identifies instrument changes. If the serial prefix of your instrument differs from that listed on the title page of this manual, there are differences between this manual and your instrument. Instruments having higher serial prefixes are covered with a "Manual Changes" sheet included with this manual. If the change sheet is missing, contact the nearest Hewlett-Packard Sales and Service Office listed at the back of this manual. Instruments having a lower serial prefix than that listed on the title page are covered in Section VII.

1-11. ACCESSORIES

1-12. *Table 1-2* lists accessory equipment supplied and *Table 1-3* lists accessories available.

Table 1-2. Equipment Supplied

DESCRIPTION	HP PART NUMBER
Detachable Power Cord 229 cm (7½ feet long)	8120-1378

Table 1-3. Accessories Available

DESCRIPTION	HP PART NUMBER
Rack Mounting Adapter Kits:	
Rack Mount with Handles attached	5020-8874
Rack Mount with Handles removed	5020-8862
Signature Analyzer	Model 5004A
2—1300 MHz Preamplifier	Model HP 10855A
Time Interval Probes	Model 5363B

1-13. DESCRIPTION

1-14. The HP Model 5335A is a Universal Counter capable of measuring input signals up to 200 MHz. The instrument's basic measurement functions include Frequency, Period, Time, Ratio, Totalize, and Volts. The resident microprocessor and MRC (multiple-register-counter) greatly expand the usefulness of the counter by performing post measurement data manipulation. This allows the additional power and convenience of user-defined measurement function keys for Statistical Data, Math Functions, Pulse Width, Rise/Fall Time, Slew Rate, Duty Cycle, and Phase Relationship. Interpolating oscillators, phase-locked to the instrument's time base, allow measurements to be resolved near 1 nanosecond.

1-15. The 5335A front-end provides two independent input channels, featuring matched high performance 200 MHz input amplifiers. Each input channel includes a full compliment of input signal conditioning controls. Additionally, the 5335A offers extensive control of triggering and arming. Most measurements are displayed in engineering notation, with the digits grouped into three's for convenience. Four modes of gate selection are provided on the front panel.

1-16. HP-IB provides remote control of programming and data output.

1-17. OPTIONS

1-18. The following lists the options available for the 5335A. Specifications for the options are given in *Table 1-1*. If an option is included in the initial order, it will be installed at the factory and ready for operation upon receipt. If an option is available for field installation, it will be

supplied as a retrofit kit. For field installation of Options 010, 020, and 030, refer to Section II for kit part numbers and instructions.

Option	Description
010	High Stability Time Base (Oven Oscillator)
020	DC Voltmeter Module
030	C Channel Input Module

1-19. RECOMMENDED TEST EQUIPMENT

1-20. The test equipment listed in *Table 1-4* is recommended for use during performance tests, adjustments, and troubleshooting. Substitute test equipment may be used if it meets the required characteristics listed in the table.

Table 1-4. Recommended Test Equipment

INSTRUMENT	REQUIRED SPECIFICATION	RECOMMENDED HP MODEL	USE
Oscilloscope	200 MHz bandwidth, X-Y capability	1715A	T, A
Digital Voltmeter	20V range, 0.05V resolution	3456A/B	A, T
Signature Analyzer	5335A compatibility	5004A	T
Controller	HP-IB compatible • HP-IB interface for 9825A • String-Adv. Programming ROM • Plotter-Gen I/O — Extended I/O	9825A 98034A 98210A 98214A	OV OV OV OV
Function Generator		3312A	A, P, OV
Signal Generator	200 MHz bandwidth	8654A/B	OV, P
50Ω RF Termination	SMC type	1250-0839	T
Synthesized Signal Generator	1300 MHz, 150 mV rms	8660B/86602B	A, OV, P
Front Panel switch replacement tool (heat stacking tool)		5020-8160	T
Flat Ribbon assembly	26-AWG, 18-conductors	8120-2463	T

T = Troubleshooting
A = Adjustments
P = Performance Tests
OV = Operational Verification

SECTION II INSTALLATION

2-1. INTRODUCTION

2-2. This section contains information for unpacking, inspection, storage, and installation.

2-3. UNPACKING AND INSPECTION

2-4. If the shipping carton is damaged, inspect the instrument for visible damage (scratches, dents, etc.). If the instrument is damaged, notify the carrier and the nearest Hewlett-Packard Sales and Service Office immediately (offices are listed at the back of this manual.) Keep the shipping carton and packing material for the carrier's inspection. The Hewlett-Packard Sales and Service Office will arrange for repair or replacement of your instrument without waiting for the claim against the carrier to be settled.

2-5. PREPARATION FOR USE

2-6. Power Requirements

2-7. The 5335A requires a power source of 100-, 120-, 220-, or 240-volt ac, +5%, -10%, 48 to 66 Hz single phase.

2-8. Line Voltage Selection

2-9. The HP 5335A Universal Frequency Counter is equipped with a power module that contains a printed circuit line voltage selector card to select 100-, 120-, 220-, or 240-volt ac operation. Before applying power, the pc selector card must be set to the correct position and the correct fuse must be installed as described below.

CAUTION

Before connecting the instrument to ac power lines, be sure that the voltage selector is properly positioned as described below.

2-10. Power line connections are selected by the position of the plug-in pc selector card in the module. When the card is plugged into the module, the only visible markings on the card indicate the line voltage to be used. The correct value of line fuse, with a 250-volt rating, must be installed after the card is inserted. This instrument uses a 1A fuse (HP Part No. 2110-0360) for 100/120-volt operation; a 0.5A fuse (HP Part No. 2110-0202 for 220/240-volt operation.

2-11. To convert from one line voltage to another, the power cord must be disconnected from the power module before the sliding window covering the fuse and card compartment can be moved to expose the fuse and circuit card. See *Figure 2-1*.

2-12. Pull on the fuse lever to remove the fuse and then pull the card out of the module. The fuse lever must be held to one side to extract and insert the card. Insert the card so the marking that agrees with the line voltage to be used is visible.

2-13. Return fuse lever to normal position, insert correct fuse, slide plastic window over the compartment, and connect the power cord to complete the conversion.

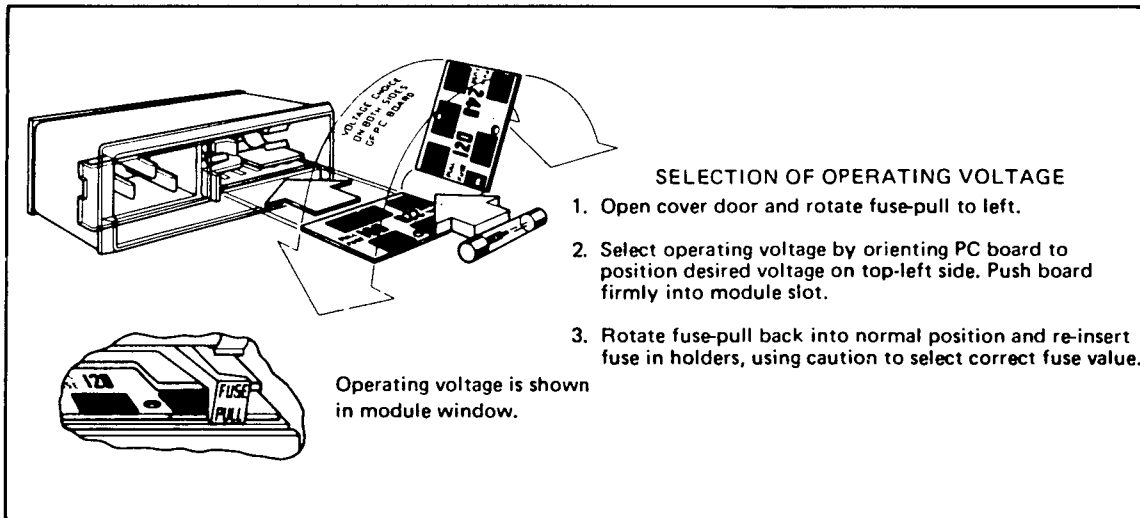

Figure 2-1. Line Voltage Selection

2-14. Power Cable

WARNING

BEFORE SWITCHING ON THIS INSTRUMENT, THE PROTECTIVE EARTH TERMINALS OF THIS INSTRUMENT MUST BE CONNECTED TO THE PROTECTIVE CONDUCTOR OF THE (MAINS) POWER CORD. THE MAINS PLUG SHALL ONLY BE INSERTED IN A SOCKET OUTLET PROVIDED WITH A PROTECTIVE EARTH CONTACT. THE PROTECTIVE ACTION MUST NOT BE NEGATED BY THE USE OF AN EXTENSION CORD (POWER CABLE) WITHOUT A PROTECTIVE CONDUCTOR (GROUNDING).

2-15. The 5335A is shipped with a three-wire power cable. When the cable is connected to an appropriate ac power source, this cable connects the chassis to earth ground. The type of power cable plug shipped with each instrument depends on the country of destination. Refer to Figure 2-2 for the part numbers of the power cable and plug configurations available.

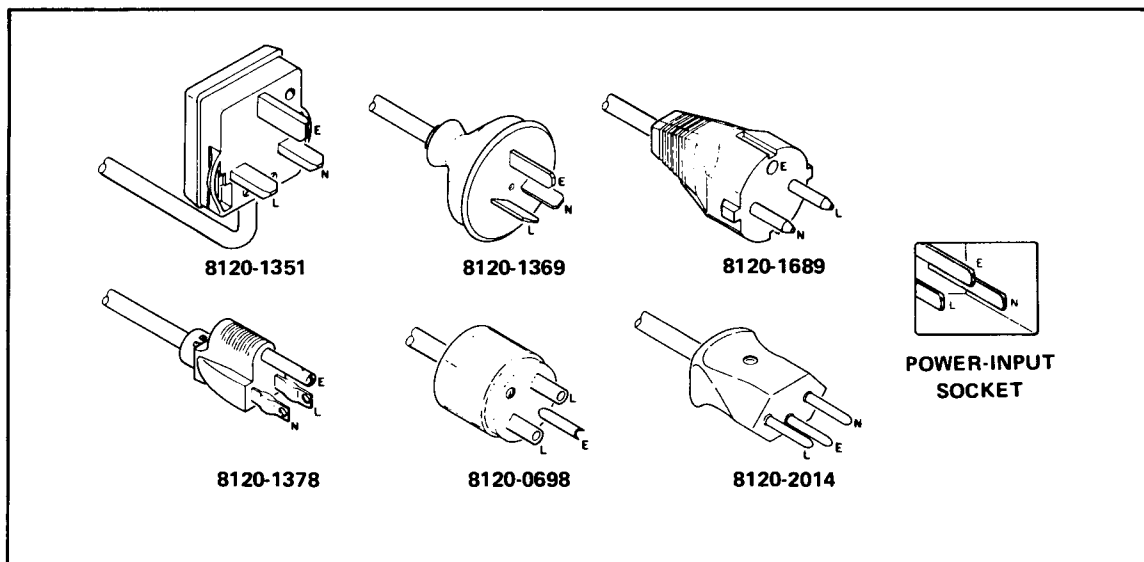

Figure 2-2. Power Cable HP Part Numbers versus Mains Plugs Available

2-16. Operating Environment

2-17. TEMPERATURE. The 5335A may be operated in temperatures from 0°C to +55°C.

2-18. HUMIDITY. The 5335A may be operated in environments with humidity up to 95%. However, it should be protected from temperature extremes which cause condensation in the instrument. Option 020, DVM, may be operated in environments with humidity up to 80%.

2-19. ALTITUDE. The 5335A may be operated at altitudes up to 4,600 metres (15,000 feet).

2-20. HP-IB INTERCONNECTIONS

2-21. HEWLETT-PACKARD INTERFACE BUS. Interconnection data concerning the rear panel HP-IB connector is provided in *Figure 2-3*. This connector is compatible with the HP 10631A/B/C/D HP-IB cables. The HP-IB system allows interconnection of up to 15 (including the controller) HP-IB compatible instruments. The HP-IB cables have identical "piggyback" connectors on both ends so that several cables can be connected to a single source without special adapters or switch boxes. System components and devices may be connected in virtually any configuration desired. There must, of course, be a path from the calculator (or other controller) to every device operating on the bus. As a practical matter, avoid stacking more than three or four cables on any one connector. If the stack gets too large, the force on the stack produces great leverage which can damage the connector mounting. Be sure each connector is firmly (finger tight) screwed in place to keep it from working loose during use.

2-22. CABLE LENGTH RESTRICTIONS. To achieve design performance with the HP-IB, proper voltage levels and timing relationship must be maintained. If the system cable is too long, the lines cannot be driven properly and the system will fail to perform properly. Therefore, when interconnecting an HP-IB system, it is important to observe the following rules:

- a. The total cable length for the system must be less than or equal to 20 metres (65 feet).
- b. The total cable length for the system must be equal to or less than 2 metres (6.6 feet) times the total number of devices connected to the bus.
- c. To total number of instruments connected to the bus must not exceed 15.

2-23. 5335A HP-IB Address

2-24. The 5335A contains a rear panel HP-IB instrument address selection switch. There are five switches, designated A₅, A₄, A₃, A₂, A₁ which are used to select the address. Instructions for setting and changing the address are provided in Section III of this manual along with programming codes. When the instrument is turned on, the setting of the address switches is momentarily displayed in decimal.

2-25. HP-IB Descriptions

2-26. A description of the HP-IB is provided in Section III of this manual. A study of this information is necessary if the user is not familiar with the HP-IB concept. Additional information concerning the design criteria and operation of the bus is available in IEEE Standard 488-1978, titled "*IEEE Standard Digital Interface for Programmable Instrumentation*".

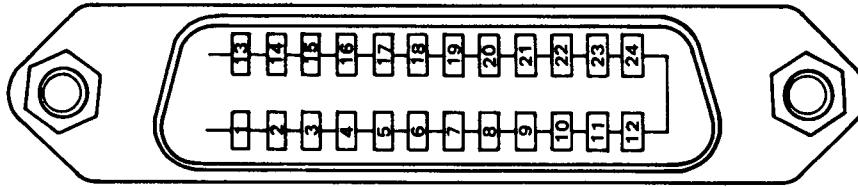

PIN	LINE
1	DIO1
2	DIO2
3	DIO3
4	DIO4
13	DIO5
14	DIO6
15	DIO7
16	DIO8
5	EOI
17	REN
6	DAV
7	NRFD
8	NDAC
9	IFC
10	SRQ
11	ATN
12	SHIELD-CHASSIS GROUND
18	P/O TWISTED PAIR WITH PIN 6
19	P/O TWISTED PAIR WITH PIN 7
20	P/O TWISTED PAIR WITH PIN 8
21	P/O TWISTED PAIR WITH PIN 9
22	P/O TWISTED PAIR WITH PIN 10
23	P/O TWISTED PAIR WITH PIN 11
24	ISOLATED DIGITAL GROUND

THESE PINS
ARE
INTERNALLY
GROUNDED

CAUTION

The 5335A contains metric threaded HP-IB cable mounting studs as opposed to English threads. Metric threaded HP 10631A, B, C, or D HP-IB cable lockscrows must be used to secure the cable to the Instrument. Identification of the two types of mounting studs and lockscrows is made by their color. English threaded fasteners are colored silver and metric threaded fasteners are colored black. DO NOT mate silver and black fasteners to each other or the threads of either or both will be destroyed. Metric threaded HP-IB cable hardware illustrations and part numbers follows.

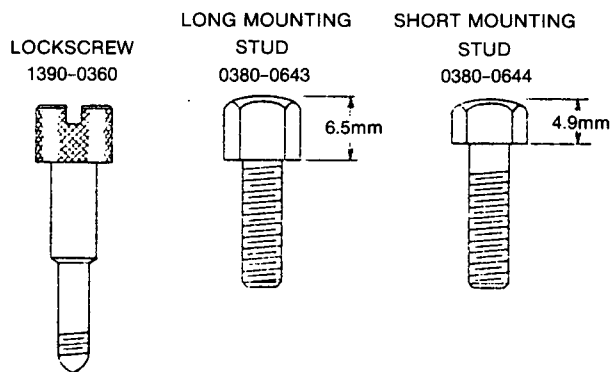

Logic Levels

The Hewlett-Packard Interface Bus logic levels are TTL compatible, i.e., the true (1) state is 0.0V dc to 0.4V dc and the false (0) state is +2.5V dc to +5.0V dc.

Programming and Output Data Format

Refer to Section III, Operation

Mating Connector

HP 1251-0293; Amphenol 57-30240.

Mating Cables Available

HP 10631A, 1 metre (3.3 ft.), HP 10631B, 2 metres (6.6 ft.),
HP 10631C, 4 metres (13.2 ft.), HP 10631D, 1/2 metre (1.6 ft.).

Cabling Restrictions

1. A Hewlett-Packard Interface Bus System may contain no more than 2 metres (6.6 ft.) of connecting cable per instrument.
2. The maximum accumulative length of connecting cable for any Hewlett-Packard Interface Bus System is 20.0 metres (65.6 ft.).

Figure 2-3. Hewlett-Packard Interface Bus Connection

2-27. FIELD INSTALLATION OF OPTIONS

2-28. To obtain the necessary parts for installation of an option, order by part number as listed in Table 2-1.

Table 2-1. Field Installable Options

OPTION	DESCRIPTION	DESIGNATOR	PART NUMBER	QTY
010	A15 Oven Oscillator Assembly	A15	10811-60101	1
	5/32 × 5/16 screw		2360-0115	2
	Fiber washer		3050-0005	2
	Retrofit Kit Number (includes all parts in Option 020)		05335-60202	
020	A8 DVM Board Assembly	A8	05335-60008	1
	DVM Front Panel		05335-00007	1
	Positive Cable Assembly	A8W1	05335-60110	1
	Negative Cable Assembly	A8W2	05335-60111	1
	Plastic nut (3/8 in. – 13 mm)		2950-0144	2
	Retrofit Kit Number (includes all parts in Option 030)		05335-60203	
030	A9 Channel C Board Assembly	A9	05335-60009	1
	Channel C Front Panel		05335-00008	1
	Channel C RF Cable Assembly	A9W1	05335-60105	1
	Channel C Sensitivity Cable Assembly	A9W2	05335-60106	1
	Pre-amp Power Cable Assembly	A9W3	05335-60109	1
	Fuse holder		05305-20104	1
	Teflon insulator		05305-20105	1
	Special BNC		05305-60205	1
	SMC Connector		05305-60206	1
	Hex nut		0590-0038	1
	0.12A mini-axial fuse		2110-0301	1
	Lockwasher		2190-0068	1
	Plastic nut (3/8 in. – 13 mm)		2950-0144	1

2-29. Field Installation Of Option 010

2-30. To install Option 010, first obtain parts listed in Table 2-1, then proceed as follows:

- a. Disconnect the power cable from the 5335A (safety precaution).

WARNING

THE AC POWER CIRCUITS TO TRANSFORMER T1 AND THE UNREGULATED DC VOLTAGE ARE STILL ON EVEN WHEN THE POWER SWITCH IS OFF. CONTACT WITH THESE CIRCUITS CAN RESULT IN INJURY TO PERSONNEL OR DAMAGE TO EQUIPMENT.

- b. Remove the top and bottom covers of the 5335A.
- c. Remove electrical lead (jumper), P/N 8159-0005, that connects A4U1B(6) and U2B(6).
- d. Apply power to the 5335A and check all voltages at A4XA15 connector per A4 schematic diagram, especially A4XA15 (14).
- e. Disconnect the power cable from the 5335A.
- f. Plug the oven oscillator (either 10544A or 10811A) into A4XA15 and secure oven oscillator to A4 assembly from underneath, with two screws (5/32 × 5/16) and fiber washer provided (P/N 3050-0005).

- g. Restore top and bottom covers to the 5335A.
- h. Apply power to the 5335A and verify counter operation by performing the operational verification in Section IV.

2-31. Field Installation Of Option 020

2-32. To install Option 020, order parts listed in *Table 2-1* or order Retrofit Kit P/N 05335-60202, then proceed as follows:

- a. Disconnect power cable from the 5335A (safety precaution).
- b. Remove the top and strapped-side cover (right side) of the 5335A.
- c. Remove blank panel by removing the two $\frac{5}{16}$ nuts that holds the blank panel to the front panel.
- d. Install Positive cable assembly, P/N 05335-60110, through the upper hole of the DVM front panel (P/N 05335-00007) and the corresponding hole in the main frame, and secure the cable and panel with $\frac{3}{8}$ in. (13 mm) plastic nut, P/N 2950-0144, to the frame.
- e. Install Negative cable assembly, P/N 05335-60111, through the lower hole of the DVM front panel and the corresponding hole in the main frame, and secure it with plastic nut.
- f. Use tie-wraps to bind the positive and negative cable assemblies together.
- g. Connect the Positive cable (red/blue) assembly to terminal marked "INPUT" on the circuit side of the DVM board assembly; connect the Negative cable (black) assembly to terminal marked "COM" on same side of board.
- h. Install DVM board into A2XA8 connector of the A2 amplifier support board (see assembly locator, *Figure 8-24*); secure A8 with two pozidriv screws to main frame.
- i. Perform Option 020 adjustment as described in paragraph 5-17.
- j. Replace side and top covers.

2-33. Field Installation Of Option 030

2-34. To install Option 030, order parts listed in *Table 2-1* or order Retrofit Kit 05335-60203, then proceed as follows:

- a. Disconnect power cable from the 5335A (safety precaution).
- b. Remove top and strapped-sided cover of the 5335A.
- c. Remove blank panel by removing the two $\frac{5}{6}$ hex nuts that holds blank panel to the main frame.
- d. Install Special Input BNC (provided) through the lower hole of the Channel C front panel (P/N 05335-00008) and the corresponding hole in the main frame, and secure the special BNC and panel with hex nut, P/N 0590-0038, to the frame as illustrated in *Figure 2-4*.
- e. Connect the brass SMC connector on one end of A9W1 to the INPUT C BNC; connect the other end of A9W1 to A9J3.
- f. Install Preamp Power Cable assembly (A9W3) through the middle hole of Channel C front panel, and secure it with plastic nut, P/N 2950-0144, to the frame; connect the other end of A9W3 red and white wires to A9J4 (to test pins marked "R" and "W").
- g. Install Sensitivity cable assembly (A9W2) through the upper hold of Channel C front panel and secure it with a $\frac{5}{16}$ hex nut; install the Channel C sensitivity control knob; connect the other end of A9W2 cable to A9J1.

- h. Install A9 Channel C board into A2XA9 connector of the A2 amplifier support board (see assembly locator, *Figure 8-24*). Secure A9 with a pozidriv screw to main frame.
- i. Perform Option 030 adjustment as described in paragraph 5-19.
- j. Replace side and top covers.

2-35. When Option 030 C Channel is installed, the operator may be required to replace the input BNC fuse. This is a 1/8A fuse (HP Part No. 2110-0301) which is located within the INPUT C BNC connector (see *Figure 2-4* for details). To replace the fuse, disconnect the power cord, unscrew the special BNC barrel (P/N 05305-60205) and, with needle-nose pliers, remove and replace the fuse. Reinstall the BNC barrel, and tighten using a BNC cable connector. Be careful not to overtighten.

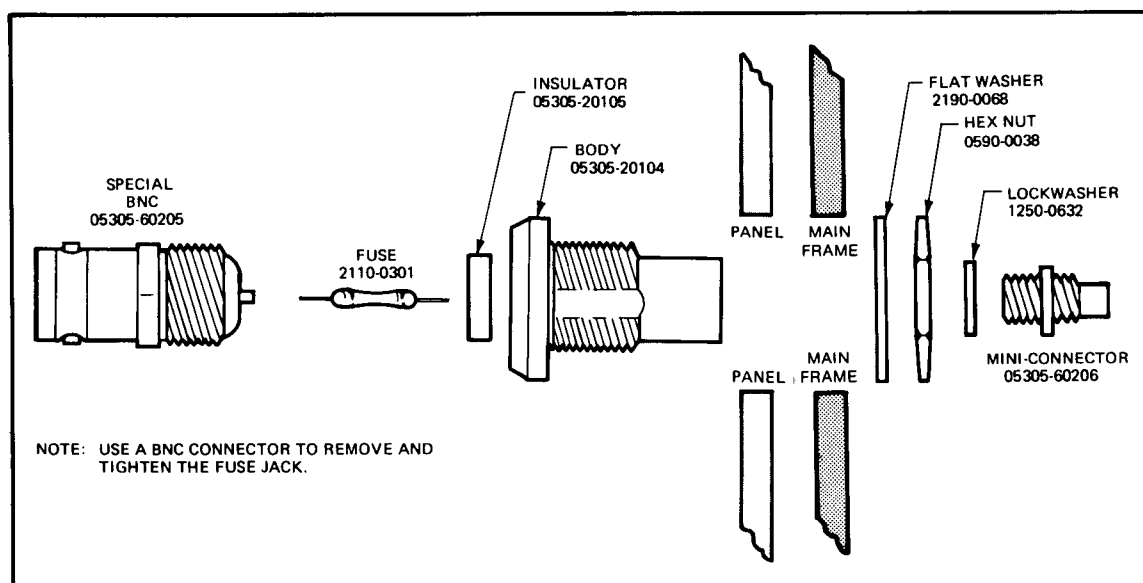

Figure 2-4. Details of Input Connector J1 and Fuse Mounting

2-36. STORAGE AND SHIPMENT

2-37. Environment

2-38. The instrument may be stored or shipped in environments within the following limits:

TEMPERATURE	-40°C to +75°C
HUMIDITY	Up to 95%
ALTITUDE	7,620 metres (25,000 feet)

2-39. The instrument should also be protected from temperature extremes which cause condensation within the instrument.

2-40. Packaging

2-41. ORIGINAL PACKAGING. Containers and materials identical to those used in factory packaging are available through Hewlett-Packard offices. If the instrument is being returned to Hewlett-Packard for servicing, attach a tag indicating the type of service required, return address, model number, and full serial number. Also, mark the container FRAGILE to ensure careful handling. In any correspondence, refer to the instrument by model number and full serial number.

2-42. OTHER PACKAGING. The following general instructions should be used for repacking with commercially available materials:

- a. Wrap instrument in heavy paper or plastic. (If shipping to Hewlett-Packard office or service center, attach tag indicating type of service required, return address, model number, and full serial number.)
- b. Use a strong shipping container. A double-wall carton made of 350-pound test material is adequate.

CAUTION

The instrument front handles must be left attached to avoid damage to controls.

- c. Use a layer of shock-absorbing material 70 to 100 mm (3- to 4-inch) thick around all sides of the instrument to provide firm cushioning and prevent movement inside container. Protect control panel with cardboard.
- d. Seal shipping container securely.
- e. Mark shipping container FRAGILE to ensure careful handling.
- f. In any correspondence, refer to instrument by model number and full serial number.

SECTION III OPERATION AND PROGRAMMING

3-1. INTRODUCTION

3-2. This section provides the operating and programming information for the HP 5335A Universal Counter. It explains the operating characteristics, operating functions, controls, and all modes of operation. Detailed operating instructions, an operator's check, and remote programming information are provided in this section.

3-3. OPERATING CHARACTERISTICS

3-4. The 5335A is a system and benchtop universal counter. Basic functions include frequency, period, time, ratio, totalize, and volts. Inputs enter into two 200 MHz matched amplifiers and are measured by the multiple register counter IC (MRC). Raw data from the measurements are used by the counter's microprocessor to compute and format the result for display. Extensive triggering and arming of the counter give the user great control over measurements. Math and statistical functions give the user flexibility over how the measurement is displayed. The operating range, resolution and accuracy for each individual functional mode of operation is given in the Specifications, *Table 1-1*.

3-5. Description, operating and programming instructions for Options 020 and 030 are provided in this section.

3-6. LOCAL OPERATION

3-7. The local operation of the HP 5335A is presented through the following subsections:

GENERAL OPERATION INFORMATION. The general operation information (starting with paragraph 3-13) describes a variety of functionally nonspecific operating instructions, operating characteristics, and indications. It provides a general overview of the front panel operating controls and indicators.

FRONT AND REAR PANEL FEATURES. The front and rear panel features provides a complete functional description of all operator controls and indicators. This information compliments and expands on the front and rear panel foldouts, *Figures 3-1* and *3-2*.

DETAILED OPERATING INSTRUCTIONS. The detailed operating instructions (starting with paragraph 3-93) present the most comprehensive information about each specific measurement function. They are categorized by the labeled function mode (e.g., *FREQ A*, *PER A*), and provide simple keystroke examples.

3-8. Additionally, the top cover of the instrument provides an Operating Instructions label. This label summarizes the general operating instructions for most of the counter's functions. A copy of the Operating Instructions label is shown on a foldout at the end of this section.

3-9. REMOTE OPERATION

3-10. A description of remote programming operation begins with paragraph 3-151. A good working knowledge of local operation is essential for HP-IB programming, as most of the Data messages contain the same keystroke-like sequences. Where applicable, throughout this section,

program examples are provided. The information within the Remote Operation includes the following:

General HP-IB Information	Learn Mode Programming
Interface Function	SRQ and Status
Bus Messages	Program Execution/Response Times
Address Selection	Output Format
Device Command Definitions	Output Modes
Device Commands	Programming Examples
Default and Power-up States	

3-11. OPERATOR'S SELF-CHECK PROCEDURE

3-12. This section, beginning with paragraph 3-225, includes checks that allow the operator to make a quick evaluation of the counter's operation. These checks will fundamentally verify the following:

- Keyboard
- Display and Annunciators
- Memory; RAM and ROM
- HP-IB

3-13. GENERAL OPERATION INFORMATION

WARNING

BEFORE THE INSTRUMENT IS SWITCHED ON, ALL PROTECTIVE EARTH TERMINALS, EXTENSION CORDS, AUTOTRANSFORMERS AND DEVICES CONNECTED TO IT SHOULD BE CONNECTED TO A PROTECTIVE EARTH GROUNDED SOCKET. ANY INTERRUPTION OF THE PROTECTIVE EARTH GROUNDING WILL CAUSE A POTENTIAL SHOCK HAZARD THAT COULD RESULT IN PERSONAL INJURY.

ONLY THE 250V FUSES WITH THE REQUIRED RATED CURRENT AND SPECIFIED TYPE SHOULD BE USED. DO NOT USE REPAIRED FUSES OR SHORT CIRCUITED FUSEHOLDERS. TO DO SO COULD CAUSE A SHOCK OR FIRE HAZARD.

3-14. Power-Up/Self-Check

3-15. When the counter is turned on, an internal check is made of several major components in its circuitry. During this cycle, all front panel segments and indicators will light momentarily, followed by the momentary display of the instrument's decimal HP-IB address (e.g., HP-IB Addr 28).

3-16. After the power-up sequence, the counter will *initialize* itself. All math and statistics will be off, the function will be Frequency A, and the gate and cycle modes will be in Norm. All of the input controls will be set according to their switch positions.

3-17. Any failures during the power-up cycle will disable the counter and produce a display of numbered error or fail messages. Within the 5335A, fail messages generally indicate a hardware failure, and error messages indicate the user has attempted an improper operation. Refer to Error Messages, paragraph 3-229.

3-18. Display

3-19. The number to be displayed is formatted into engineering notation with the digits grouped into threes for convenient reading and an exponent with a range of ± 18 . When dis-

playing 11 and 12 digit numbers, the grouping is omitted. The number of digits displayed is determined by the function and gate time. In most cases, a longer gate time gives more digits.

3-20. When resolution calls for more than 12 digits no overflow results. Instead, the MSD's are retained, and the display is reduced to 12 digits.

3-21. The exponent range of the display is ± 18 . If a number cannot be displayed the display will show one of these two numbers.

0. +19 (0×10^{19}) if the number is too large.

0. -19 (0×10^{-19}) if the number is too small.

NOTE

If you suddenly see two less digits in frequency, period, or time interval measurements, there may be a failure in the interpolators. If you press RESET you may get these digits back, or you may get a FAIL message. See the section on diagnostics in Section VIII.

3-22. Annunciators indicate the Hertz, Seconds, and Volts units. For some functions the units are not indicated, but assumed, such as degrees for phase measurements. For slew rate, both the Volts and Seconds annunciators are on to indicate Volt/second.

3-23. The GATE light shows the status of the counter's gate. Before the measurement starts, this light is off, indicating that the gate is closed. During the measurement, the light is on, indicating that the gate is open.

3-24. The TALK, LISTEN, SRQ, and REMOTE lights monitor the status of the HP-IB. Refer to Programming, paragraph 3-151.

3-25. Keyboard

3-26. The keyboard is divided into several groups, according to the purpose of the keys. From the left, we have MATH/STATISTICS, FUNCTION, GATE/CYCLE, INPUT, and if installed, INPUT C (Option 030), and VOLTS (Option 020). With exceptions, each group operates fairly independently of the others. The operation of each front panel key, within each keyboard group, is presented in Front Panel Features, beginning with paragraph 3-37.

3-27. Key Indicators

3-28. The operation of individual keys is relatively straightforward. Indicator LED's, in the center of many keys, represent that key's status. A steady "on" LED indicates that the key's labeled function is active or in-effect. An "off" LED indicates that the key's labeled function is not active or disabled. Many keys operate in a toggle on/off fashion. The blue colored keys in the MATH function group can be programmed. A "blinking" LED within a blue key is used as a "prompt" for the operator. It indicates that it is waiting for a data entry. Number entries are made from the keys labeled in blue. Refer to paragraph 3-72.

3-29. Keyboard Memory

3-30. To avoid having to re-enter math constants, etc., whenever switching between two functions repetitively, the keyboard has one level of memory. This allows you to set up two functions modes, each with their own set-ups. The key set-ups for each of the keys in the MATH, STATISTICS, FUNCTION, GATE, and CYCLE groups are automatically memorized. Controls within the INPUT group are not memorized.

3-31. Reading the convenience functions GATE TIME or TRIG LVL will not affect the keyboard memory. Any changes to the key set-ups while in these functions will be carried back to the set-up of the function that was active before. GATE TIME and TRIG LVL are not affected by MATH and STATISTIC functions. For example:

1. Presently in **FREQ A**, we enter an **OFFSET** of 123.
2. We switch to **PER A**, where we see by the **OFFSET** key indicator, that the **OFFSET** is off.
3. Selecting **FREQ A**, we see that the **OFFSET** is again 123.
4. We then select **TRIG LVL**, and then **GATE TIME**.
5. While in **GATE TIME** we set the **GATE MODE** to **FAST**.
6. Returning to **FREQ A**, we still have an **OFFSET** 123, but also, the **GATE MODE** is now in **FAST**.
7. We select **PER A**, then **PULSE A**. Now, when we return to **FREQ A**, all set-ups go to the default positions.

3-32. Key Default

3-33. The initialized and/or default positions for all operator keys and controls are as follows:

Default	{	MATH	OFF	
		STATISTICS	OFF	
		RANGE HOLD	OFF	
		EXT ARM ENABLE	OFF	
		CYCLE	NORM	
		GATE MODE	NORM	
		GATE MODE	MIN	
		(for TIME, 1/TIME, RISE/FALL, SLEW, DUTY CYC, PHASE)		
Initialize Power-Up	{	FUNCTION		FREQ A
		GATE MODE	NORM	
		CYCLE	NORM	
		RANGE HOLD	OFF	
		EXT ARM ENABLE	OFF	
		MATH	OFF	
		STATISTICS	OFF	
		INPUT		} As set by controls
		REAR		

3-34. Special Function Mode

3-35. The front panel controls allow for a direct, key-per-function selection from 16 labeled function operations. A sequence of keystrokes will allow the operator to enter a *Special Function Mode*, in which the original 16 functions, plus 4 additional unlabeled functions and an extensive diagnostic mode can be accessed. The four unlabeled “phantom” functions are:

- FREQ B
- PULSE B
- TIME B→A
- TOTALIZE A-B

3-36. The diagnostic mode allows the user considerable flexibility during troubleshooting through a set of 33 discrete, self-diagnostic test routines. A more complete description of the *Special Function Mode* and complete procedures using the diagnostic routines are provided in Section VIII.

3-37. FRONT PANEL FEATURES

NOTE

To enhance the descriptions of Front Panel features, fold out *Figure 3-1*, page 3-15, while reviewing these paragraphs.

3-38. The front panel controls, indicators, and connectors are located and briefly described in *Figure 3-1*. A good quick reference of the operating details for each function mode is provided in the Function Key Reference Summary, *Table 3-2*.

3-39. The following paragraphs describe the general purpose and use of the operator keys and controls. They are discussed by functional grouping, as follows:

- FUNCTION GROUP
- GATE CYCLE GROUP
- INPUT GROUP
- TRIGGERING (MANUAL/AUTO)
- MATH GROUP
- STATISTICS GROUP
- INPUT C (OPTION 030)
- VOLTS (OPTION 020)

3-40. Function Group

3-41. Function selection for the HP 5335A is done via a simple key per function keyboard. Sixteen function modes (labeled in black) are directly accessible from the four leftmost columns of keys. The indicator LED within the key identifies which one of the functions is active. Several more functions are available, accessed through the HP-IB, and other means (see Special Function Mode, paragraph 3-34, and Diagnostics in Section VIII). During the programming sequence for the MATH group, the functions of these 16 keys (and CHECK) are reassigned to the numeric and special entry values labeled in blue.

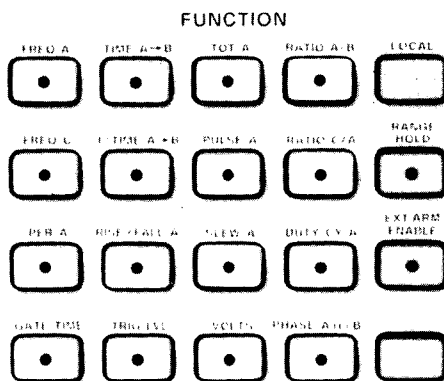

3-42. Within the FUNCTION group, the rightmost column contains four keys assigned miscellaneous functions.

3-43. The RESET key will reset the counter and start a new measurement. When pressed, all segments and decimal points in the display should light, momentarily. RESET will not affect any current function selection or key set-ups. If you are currently in GATE TIME or TRIG LEVELS, pressing RESET returns you to the function you were previously in.

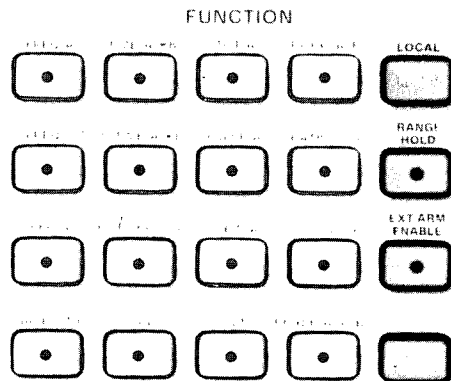

3-44. RANGE HOLD can be used to freeze the decimal point placement and exponent value of the display. Least significant digits are allowed to “fall off” the right of the display. However, the display is programmed to avoid a loss of the most significant digit. RANGE HOLD is useful when the value in the display is rapidly changing in magnitude. In the PHASE A rel B mode, RANGE HOLD will select and maintain the 0° to 360° measurement display range. RANGE HOLD toggles on and off with each press of the key.

3-45. The EXT ARM ENABLE key is used to enable or disable external arming of measurements. When it is on, the Start and/or Stop of the measurement can be armed via a signal connected to the rear panel. When off, the counter ignores the rear panel signal. EXT ARM ENABLE toggles on and off with each press of the key.

3-46. The CHECK key puts the instrument into one of two levels of self-check routines. Pressing the key once will enter a “lamp test loop” flashing all front panel annunciators, key indicators and segments, checking the MRC, and memory circuits. Pressing and holding the key (for approximately 3 seconds) will place the instrument into an extended diagnostic loop of several major circuits (i.e., amplifiers, time base, counting circuitry, and display). This test requires that the user connect the rear panel Time Base Out to the Channel A input, put both channels to 50Ω, and remove any signal to Channel B. See Operational Verification section for further details. Any failures during the diagnostic loop will result in the display of either a numbered FAIL or ERROR message. FAIL messages generally indicate a circuit failure. ERROR messages indicate the user has attempted an improper operation; for example, a misspelled HP-IB command. Refer to ERROR MESSAGES, paragraph 3-229. To exit either self-check routine, press any other function key.

3-47. Gate/Cycle Group

3-48. The GATE ADJ control sets the length of the gate time, continuously adjustable through the ranges set by the GATE MODE keys. In certain time interval functions (i.e., TIME A→B, 1/TIME, PULSE), the actual gate time is automatically determined, dependent on the input signal. In these modes, the gate time controlled by GATE ADJ, can be used as a Hold-Off Delay for the Stop channel. If a T.I. DELAY mode is selected (any GATE MODE except MIN) the red T.I. DELAY indicator will light. In these functions, the normal operation gate mode is MIN if no delay is desired. For more information about the GATE ADJ control during time domain measurements, refer to TIME A →B, paragraph 3-102.

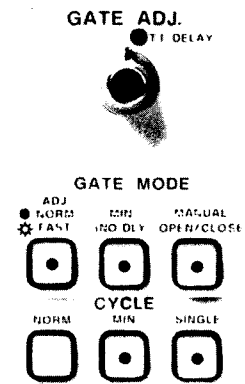

3-49. Gate mode NORM and FAST are two ranges of adjustable gate times. NORM has a range of nominally 20 ms to 4 seconds, and FAST has a range of nominally 100 μ s to 20 ms. The one key causes the mode to toggle between NORM and FAST.

3-50. Gate mode MIN specifies the shortest possible gate time. This means that the signal itself usually determines the time. For example, the Frequency A measurement uses a divide-by-2 prescaler. The gate time in this function would be determined by 2 periods of the input. MIN mode is usually the mode used when External Stop Arm is used.

3-51. The MANUAL OPEN/CLOSE key lets you specify the gate time manually. In the manual mode, each press of the key toggles the gate either open or closed. The status of the gate is indicated by the GATE annunciator. Manual mode allows very long gate times.

3-52. Cycle mode NORM specifies about a 250 ms wait time between measurements. This slows the display down to a rate that is more convenient for viewing short gate time measurements.

3-53. MIN mode tells the counter to start the next measurement as soon as possible. This gives the most rapid updating of the display.

3-54. SINGLE lets you start measurements upon manual command. Each press of the key starts one measurement. This measurement stays on the display until the key is pressed again (RESET will also start a new measurement).

NOTE

A reminder that this counter uses synchronized gating, and that the input signal also determines the length of the gate time. Additionally, several modes of Arming are available, see Rear Panel Features.

3-55. Input Group

3-56. The INPUT GROUP contains the A Channel and B Channel input BNC's, signal conditioning controls, and triggering controls.

3-57. The SLOPE key determines which edge of the signal to trigger on. For some functions it also takes on other uses. For PULSE, the Slope A switch is used to specify the positive (\nearrow) or negative (\searrow) pulse. For RISE/FALL, it is used to specify whether it is RISE or FALL time being measured. SLOPE A has a similar purpose for SLEW. For DUTY CYC, it determines whether to display the percentage high (\nearrow) or low (\searrow).

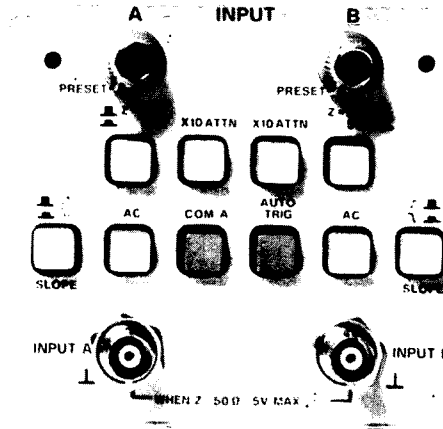

3-58. The AC key, when pressed, makes the respective input amplifier ac coupled. This is useful for ignoring dc offsets on a signal.

3-59. The input impedance of each channel is selected by the Z=1M Ω /50 Ω key. When in the 50 Ω position, the input damage level is 5V.

3-60. For inputs greater than the 5V dynamic range, or to reduce the sensitivity of the front end, the X10 ATTN key lets you attenuate the signal by a factor of 10. The 5V damage level still applies, however, when Z = 50. For convenience, the trigger level reading function will arithmetically multiply the display by 10 when the attenuators are on.

3-61. Triggering (MANUAL/AUTO)

3-62. The HP 5335A has an extensive set of triggering features which make accurate measurements on input signals easier for the user. Four modes of triggering, listed below, are directly accessible from the front panel or via the HP-IB. A fifth mode (see paragraph 3-67) is automatically selected when in the RISE/FALL A or SLEW A function modes.

Manual Adjustable
Manual PRESET
Auto Adjustable
Auto PRESET

3-63. The Manual Adjustable mode uses the trigger adjustment controls to set the trigger level anywhere between +5 and -5 volts. The actual trigger levels for both channels can be monitored by pressing the TRIG LVL function key. When the control is fully ccw (into detent) the Manual PRESET mode is selected, and the trigger level is set to 0 volts.

3-64. When the Auto Trigger mode is selected, the trigger adjustment controls assume a wholly different meaning. Pressing the AUTO TRIG key selects the Auto Adjustable triggering mode. The range of adjustability for the control is now dependent on the amplitude of the input signal, with the peaks of the input signal nominally setting the control limits.

3-65. Assume, for example, an input signal of 2 volts p-p, with Auto Adjustable triggering selected. The range of the trigger adjustment control outside of PRESET will automatically reduce from $\pm 5V$ to $0V \rightarrow +2V$. This allows a much finer control over the trigger level setting. The actual trigger levels for both channels can be monitored by pressing the TRIG LVL function key.

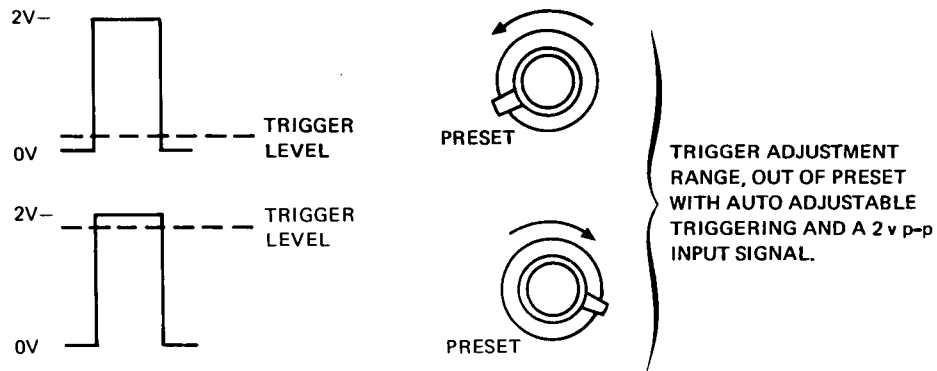

3-66. Pressing the AUTO TRIG key, with the trigger adjustment control in PRESET, selects the Auto PRESET triggering mode. In this mode, peak detectors on both channels determine the peaks of the input signal. The trigger level is automatically set to the 50% point of the peaks, regardless of the dc offset of the input.

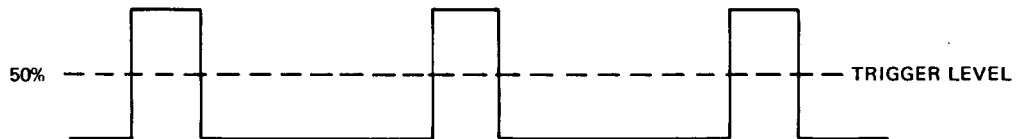

3-67. An additional mode of triggering is used by the functions RISE/FALL A and SLEW A. The peaks of the input signal are determined and the 10% and 90% points are found. These dc levels are assigned as trigger levels by the respective SLOPE keys, to Channels A and B. Pressing TRIG LVL will display the 10% and 90% levels determined.

3-68. The front panel 3-state Trigger Lights provide a visual indication of each channel's triggering status. When the light is on, the trigger level is set too low (or the signal is too high). When the light is off, the trigger level is set too high (or the signal is too low). When the light is flashing, the trigger level is set within the peak limits of the input signal (\pm the hysteresis offset of the input amplifier) and the channel is triggering.

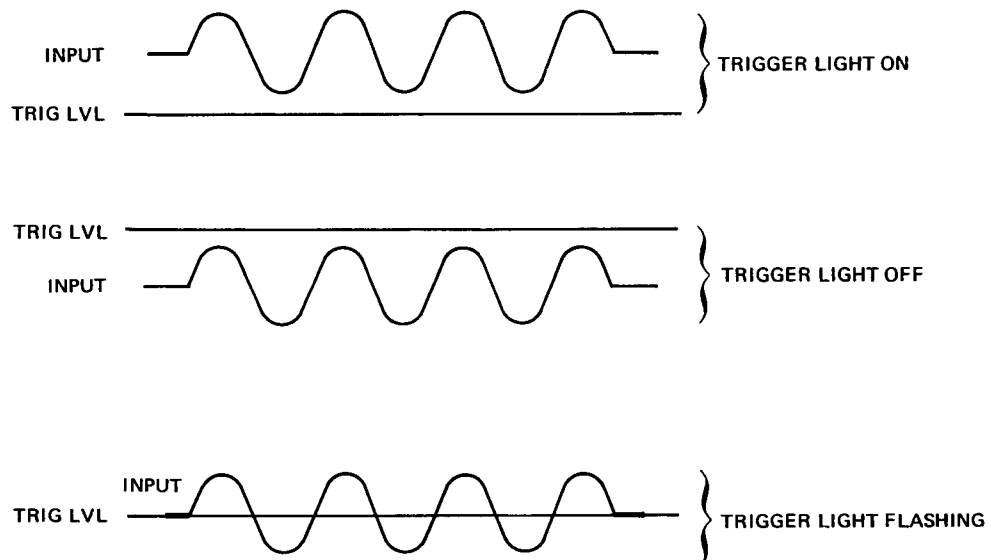

3-69. Math Group

3-70. The functions within the MATH GROUP allow the user to perform a number of mathematical operations on the measurement before it is displayed. The OFFSET, NORMLZ, and SCALE keys allow for the addition, division, and multiplication, respectively, of the measurement by user specified constants. Modification of the display by the Math operations is represented by the following relationship:

$$\text{Display} = \frac{\text{Measurement} + \text{OFFSET}}{\text{NORMLZ}} \times \text{SCALE}$$

3-71. Notice that the OFFSET operation is performed before normalization and scaling. Any single or combination of these operations can be selected. This provides the user with extensive control over the resultant display. It can be used, for example, to subtract systematic errors or display the percentage difference. Additionally, the overall math operation can be disabled and then re-established without having to re-enter constants.

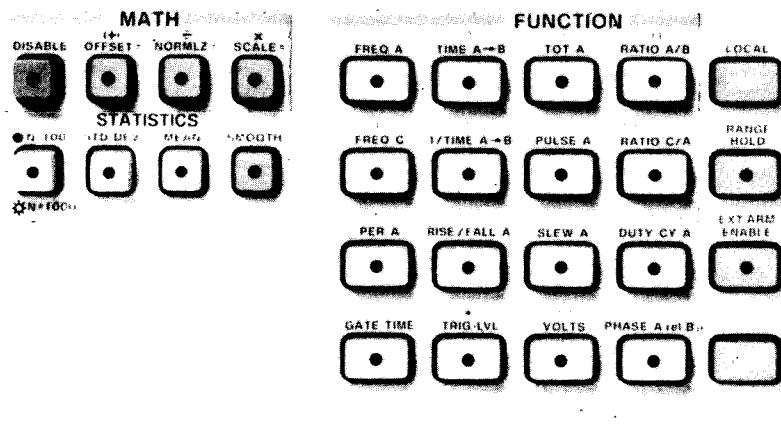

3-72. ENTERING CONSTANTS. The values for the three user specified constants are entered from the keyboard. Entry begins by pressing any one of three blue keys, OFFSET, NORMLZ, or SCALE. That indicator key's light will start to flash, indicating that an entry is expected. During the number entry mode, the FUNCTION keys respond to the functions labeled in blue (see Table 3-1). Any entry is completed by pressing the ENTER key, at which time the blue key's light will turn on (steadily), indicating that a constant for that operation is stored and in effect. After pressing ENTER, the instrument will immediately begin making measurements, performing the math operation and displaying the result.

NOTE

Numbers greater than 9×10^9 and less than 1×10^{-9} in magnitude can not be stored.

Table 3-1. Function Key Use During Number Entry

FUNCTION KEY	FUNCTION DURING NUMBER ENTRY						
0-9, "."	Digit entry. Before EEX is pressed, these are used to enter the mantissa value. Up to 11 digits are allowed. After EEX is pressed, these are used to enter the exponent value.						
EEX	Enter Exponent. Begins exponent entry when pressed.						
CHS	CHange Sign. Toggles the sign of the mantissa or exponent, depending upon whether EEX was pressed.						
CLR	CLearS entry.						
ENTER	Completes entry of number. After ENTER is pressed, the instrument goes back to making measurements. If the value entered was zero, the specified constant is turned "off". This is indicated by turning the key's LED off. If the value entered was not zero, the specified constant is turned "on". This is indicated by turning the key's LED on. When a constant is "off" it is ignored in the equation.						
RESET	During number entry, RESET can be used to abort the entry and return to normal operation.						
DISABLE	During number entry, this key produces the same effect as entering zero as the value. The specified constant is turned off and normal operation begins. ENTER does not have to be pressed.						
SPECIAL NUMBER ENTRY KEYS							
LAST DISP	This key will put on the display the value that was displayed from the last measurement. If you are presently entering in a value to OFFSET, the last display value is negated. This lets you conveniently subtract our errors or values based on measurements you've made. For NORMLZ and SCALE, the last display value is not negated.						
MEAS _{t-1}	<p>This key does not specify any unique value, but instead, specifies that as each measurement is made, the previous measurement's value (before any mathematical manipulation) be used.</p> <table border="0" data-bbox="520 1060 1432 1129"> <tr> <td style="text-align: center;">Previous measurement (t-1)</td> <td style="text-align: center;">this measurement (t0)</td> <td style="text-align: center;">display</td> </tr> <tr> <td style="text-align: center;">1 2 3 4 5</td> <td style="text-align: center;">1 2 3 4 6</td> <td style="text-align: center;">1</td> </tr> </table> <p>This is an example of MEAS_{t-1} with OFFSET. As with LAST DISP, the value is negated for OFFSET, and not for NORMLZ and SCALE.</p>	Previous measurement (t-1)	this measurement (t0)	display	1 2 3 4 5	1 2 3 4 6	1
Previous measurement (t-1)	this measurement (t0)	display					
1 2 3 4 5	1 2 3 4 6	1					

3-73. **REVIEWING CONSTANTS.** To review the constants, press any of the blue keys. The counter will cease taking measurements and the presently specified value of the constant will be displayed. The indicator light within the blue key specified will be flashing. At this time, either the value of the constant can be changed by keying in the new number and pressing ENTER, or all of the constants can be reviewed by pressing each blue key in succession. To return to the measurement mode, press either RESET or ENTER.

3-74. **DISABLING MATH OPERATIONS.** When not in the number entry mode (i.e., a blue key has not been pressed) the DISABLE key can be used to momentarily turn off all of the math functions. The DISABLE function toggles between on and off with each press of the key. The DISABLE key's indicator light turns on when the math functions are disabled and off when the math functions are enabled. While disabled, the indicator lights within the individual math function keys are turned off.

3-75. During the number entry mode (i.e., pressing any blue key) the DISABLE key produces the same effect as entering zero (or one) as the value of the constant. The specified math function is turned off and the counter begins normal measurements. The ENTER key does not have to be pressed and the remaining math functions (if previously loaded) are reinstated.

3-76. If DISABLE is on and a blue key is pressed (number entry mode) the disable condition is defeated for the specified math function *only*. A new constant can be entered, and when ENTER

is pressed, the measurement is displayed with only that specified math function activated. The remaining functions, though programmed with constants, are still DISABLED. To reactivate these stored functions, recall each (by pressing the blue key) and then press ENTER.

3-77. SAMPLE MATH OPERATIONS. The following examples illustrate the operation of the MATH GROUP functions.

- A. With an input frequency of 10.001 MHz, enter an offset of -10 MHz:
Keystrokes: OFFSET CHS 1 EEX 7 ENTER
Measured value: 10.001 MHz
Displayed value: 1 kHz
- B. Suppose you are currently measuring a 3.56 MHz color TV crystal. To set -3.56 MHz as the offset:
Keystrokes: OFFSET LAST DISP ENTER
-3.56 E6 will be displayed
Measured value: 3.56 MHz
Displayed value: 0 Hz
- C. Suppose in the above example you wished to display percentage error instead:
Keystrokes: OFFSET LAST DISP ENTER
-3.56 E6 will be displayed
DISABLE (lets 3.56 MHz be displayed without the offset)
NORMLZ LAST DISP ENTER
3.56 E6 is now in NORMLZ
SCALE 1 0 0 ENTER (100 is now in SCALE)
OFFSET ENTER (turns OFFSET on again)
Measured value: 3.61 MHz
Displayed value: 1.4045 (percent error from 3.56 MHz)
- D. To display an measurement in rpm (revolutions per minute):
Keystrokes: SCALE 6 0 ENTER
Measured value: 100
Displayed value: 6.000 E3
- E. To show change in frequency per second (approximately, averaged over 1 second gate times):
Set Gate Adjust to a 1-second gate time, and CYCLE Mode to MIN.
Keystrokes: OFFSET MEAS_{t-1} ENTER
A "t-1" will be displayed
Measured value: 1000 Hz
Measured value: 1002 Hz
Displayed value: 2 Hz
Measured value: 1005 Hz
Displayed value: 3 Hz
More precise timing of the gate can be achieved by arming.

3-78. Statistics Group

3-79. The functions within the STATISTICS GROUP allow the user to automatically accumulate and sample 100 (or 1000) measurements and then determine and display either the standard deviation or the mean (average) of the sampling. These functions are selected by the STD DEV and MEAN keys, respectively, which toggle on and off with each press of the key. The indicator light will light when the function is activated. The sample size is initially set (default state) to 100. Pressing the N = 100/N = 1000 key will alternately toggle the sample size between 100 and 1000. The indicator light within the key will be on for a sample size of 1000, and off for 100.

NOTE

MATH calculations are done *before* statistics when both are activated.

3-80. Selecting MEAN produces one additional digit of resolution. Selecting STD DEV will display three digits for either sample size. Both the Standard Deviation and the Mean can be displayed for a single sample. To do this the measurements must be made with STD DEV on and the CYCLE MODE set to SINGLE. At the end of the N measurements (100 or 1000) the standard deviation is displayed. Then press MEAN to display the mean of the sample. The mean value is displayed with a resolution based on the standard deviation.

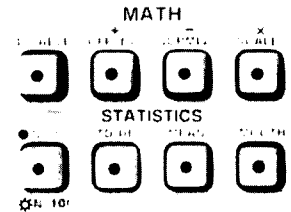

NOTE

Statistical calculations sometimes use data from the measurement that is not displayed, from the resolution lost when a number has to be rounded to the best decade.

3-81. The SMOOTH key selects a unique function which “smooths” the display for easier reading. When SMOOTH is on, the counter looks at the resultant measurement and displays only the digits that are relatively stable. In addition, as the measurements continue to cycle, a running average is made to remove small deviations. The running average is made by assigning each new measurement a weight of 1/10, and the last display 9/10.

$$\text{Smooth Display} = 1/10 \text{ New Measurement} + 9/10 \text{ Last Display}$$

3-82. This allows for slow drift in the signal, but filters out small transients. The SMOOTH function provides a simple visual way to monitor the stability of a signal. If the stability of the signal decreases, the LSD's of the display will correspondingly begin to blank out. As stability increases, the lost digits of resolution will reappear. The SMOOTH key toggles on and off, and operates independently of all other functions.

NOTE

Because Phase measurements require a steady signal input, the use of Statistics is not valid (i.e., the STD DEV of a steady signal should be 0, and MEAN should be the same as any one measurement). Therefore, the use of STATISTICS for PHASE measurements is not recommended.

3-83. Input C (Option 030)

3-84. The INPUT C GROUP contains the C Channel Input BNC, SENSITIVITY control and PREAMP POWER receptacle. The input connector is a special fused BNC. Refer to paragraph 3-221 for replacement instructions. The SENSITIVITY control varies the input sensitivity from MAX (10 mV for 150 MHz to 1.0 GHz, 100 mV for 1.0 GHz to 1.3 GHz), refer to Specifications, Table 1-1 to greater than 500 mV. The PREAMP POWER jack allows the use of an optional high frequency broadband preamplifier, such as the HP 10855A. The GATE ADJ and GATE MODE controls operate as with A Channel.

NOTE

The PREAMP POWER jack supplies a $\approx +15$ vdc and a ground output. This connector will not support a three-wire type power probe.

3-85. Volts (Option 020)

3-86. The VOLTS section contains the HI (Red) and LO (Black) input connectors for the fully floating, autoranging Digital Voltmeter. The voltmeter measures dc inputs up to ± 1000 volts. It automatically selects the ± 10 V, ± 100 V, or ± 1000 V range, depending on the input voltage. The sensitivity is 100 μ V to 100 mV (depending on the range).

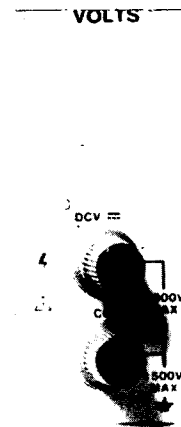
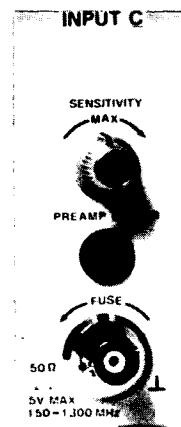

The MATH keys provide for post-measurement manipulation of the display, by the mathematical operations of OFFSET, NORMALIZE, and SCALE. Values for constants are programmed in via the numeric values of the FUNCTION keys.

The counter numeric display, providing 12 possible digits of mantissa, an exponent sign, and an engineering notation exponent 0, ±3, ±6, ±9 etc. Mantissa digits are grouped into threes for convenience, whenever possible.

The display ANNUNCIATOR group provides LED indicators for monitoring the status of the Gate, HP-IB, and units of the measurement.

The GATE ADJ. control provides the adjustability for the GATE MODES, and for adjustment of the T.I. Delay holdoff.

The INPUT C module, Option 030, provides for FREQUENCY measurements from 150 MHz up to 1.3 GHz. Controls are provided for adjustable SENSITIVITY and PREAMP POWER.

The VOLTS module, Option 020, provides a fully floating auto-ranging DC voltmeter. Input DC voltage range up to 1000V.

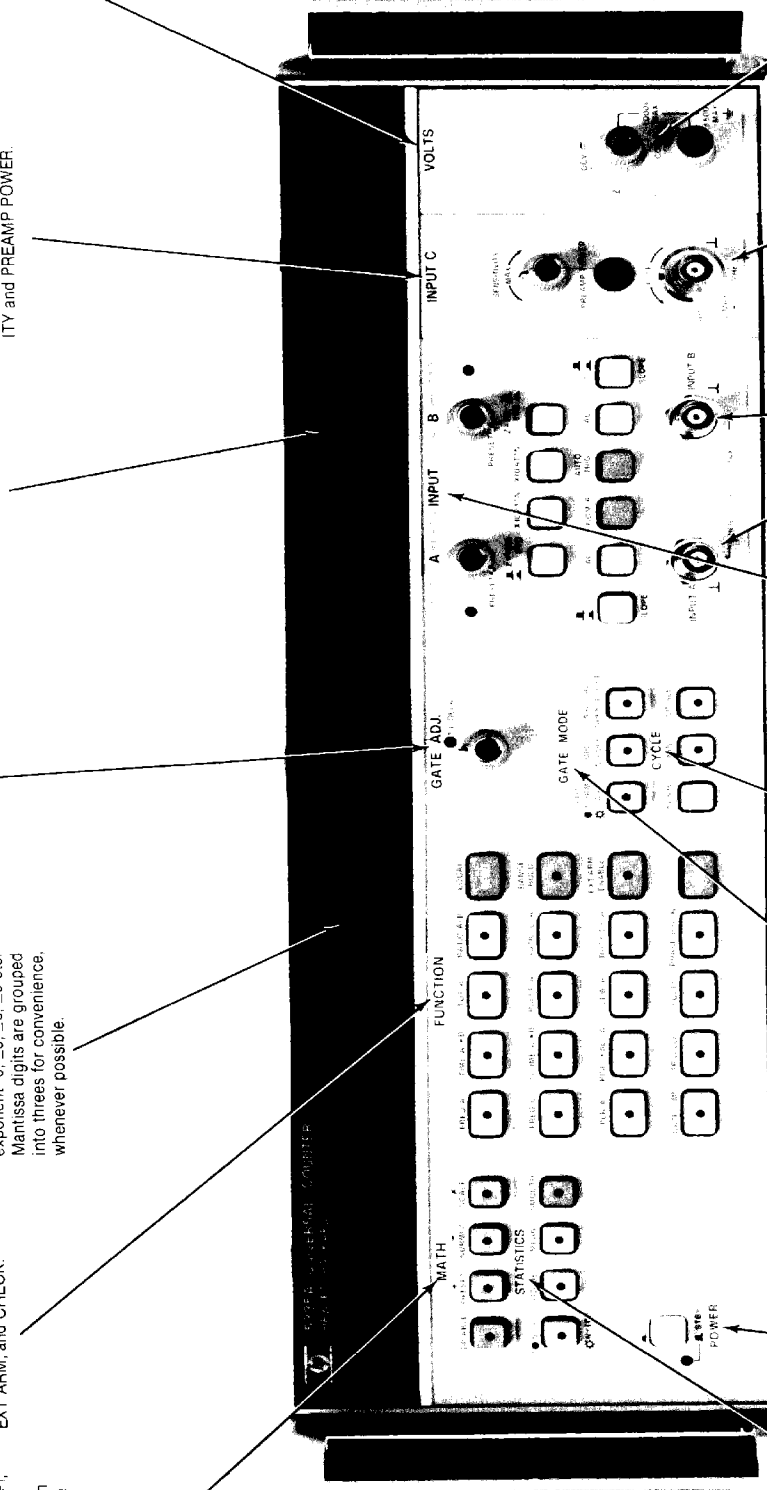

The STATISTIC keys allow for the calculation of standard deviation or mean average, of either 100 or 1000 measurement samples. The SMOOTH function performs a running average of ongoing measurements, and displays only the digits which are relatively stable.

The POWER key applies power to the instrument when in the ON position, pressed in. In the STBY position, power is applied only to the high stability reference oscillator oven, Option 010.

The GATE MODE keys select the ranges of gate time. NORM and FAST are adjustable via GATE ADJ. modes, providing ranges of 20 ns to 4 s and 100 μs to 20 ms, respectively. MIN specifies the shortest possible gate time, dependent on the input signal. MANUAL opens and closes the gate with each successive press.

The GATE MODE keys determine the length of time between measurement cycles. The NORM mode specifies about 250 ms wait time, the MIN mode rearms the measurement as soon as possible. The SINGLE mode manually starts one measurement.

The INPUT group keys and controls determine how the input signals are conditioned (with attenuation, impedance slope, coupling, and common controls), and how the counter is triggered (AUTO TRIG or normal).

The A and B Channel input BNC connectors.

The C Channel input BNC is a special fused connector. The fuse: HP Part No. 2110-0301 is 1/8A, and is accessible for replacement, from the front panel.

The input connectors for the Option 020 Voltmeter. Input voltage 1000V DC max. COM is floating.

Figure 3-1. Front Panel Features

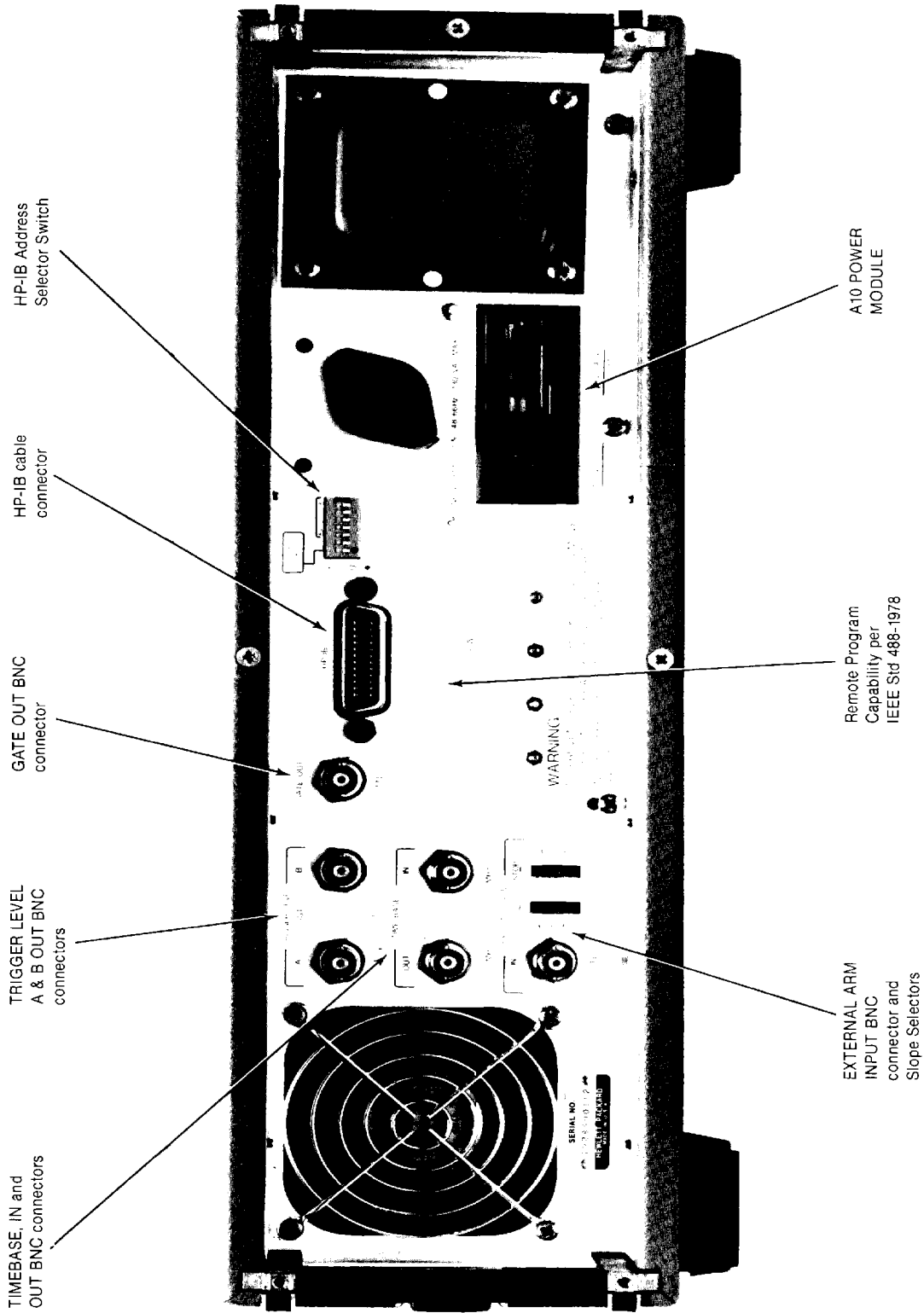

Figure 3-2. Rear Panel Features

3-87. REAR PANEL FEATURES

3-88. A number of signal inputs and outputs are provided on the rear panel. TIME BASE OUT provides a 10 MHz signal that may be used as a reference for other instruments. If the reference to the HP 5335A is provided from another source, connect it to TIME BASE IN. This input accepts either 5 or 10 MHz and internally multiplies it up to 10 MHz. Whenever a reference is applied to the TIME BASE IN connector, the presence of that signal is sensed by internal circuitry, and the HP5335A will automatically switch from the internal reference mode to the external reference mode of operation. This switchover is indicated by the lighting of the EXT TIME BASE annunciator on the front panel display. If the reference is removed, the EXT TIME BASE annunciator will not automatically turn off. Pressing the RESET key will update the status of the reference EXT TIME BASE annunciator. Do not connect TIME BASE IN to OUT. No damage will occur but the reference frequency will be incorrect.

NOTE

Always press RESET after connecting or disconnecting a signal to the TIME BASE IN. Do not connect or disconnect a signal to the TIME BASE IN during measurements. FAIL 5.1 may occur, or the measurement may give a false reading. If FAIL 5.1 does occur in this situation, pressing RESET clears the condition.

3-89. TRIGGER LEVEL OUT provides A and B Channel DC trigger levels for display on scopes. These are handy for a visual verification of proper triggering.

3-90. GATE OUT provides a low signal when the gate is open (see specifications). This can be used in many cases as a visual indication of when the measurement occurs, or the duration of the measurement.

3-91. The EXTERNAL ARM input can be used to specify the start and/or stop of a measurement. The various modes of arming are determined by the two 3-position switches. Refer to ARMING MODES, *Figure 3-3*.

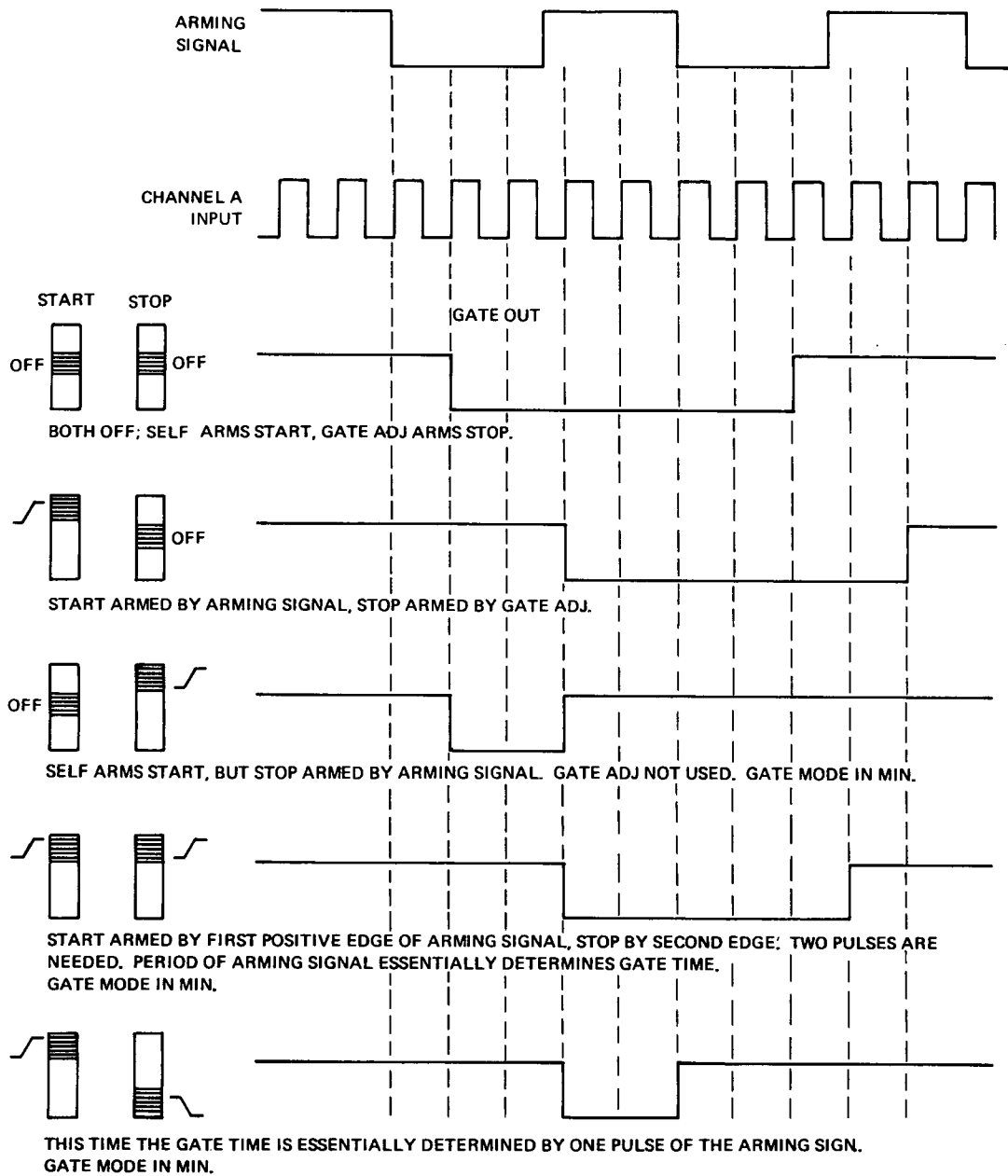

Figure 3-3. Arming Modes

NOTE

When STOP ARM is used the GATE MODE is usually used in MIN. To aid the user in this condition the 5335A will automatically set the GATE MODE to MIN when the STOP ARM is activated. However, the user can override this feature by simply selecting any other GATE MODE after setting up the ARMING modes.

3-92. When the GATE MODE is set to NORM, FAST, or MANUAL, and external arm is on, the Gate Adj timer can be used to hold off the STOP ARM.

Example:

- a. The rising edge of the ARM signal arms the START of the gate and starts the Gate Adj timer ①.
- b. The ARM signal is then ignored until the Gate Adj timer times out ②.
- c. The next falling edge of the ARM signal ③ then arms the STOP.

In this way, multiples of the arm signal's period can be used to arm the measurement.

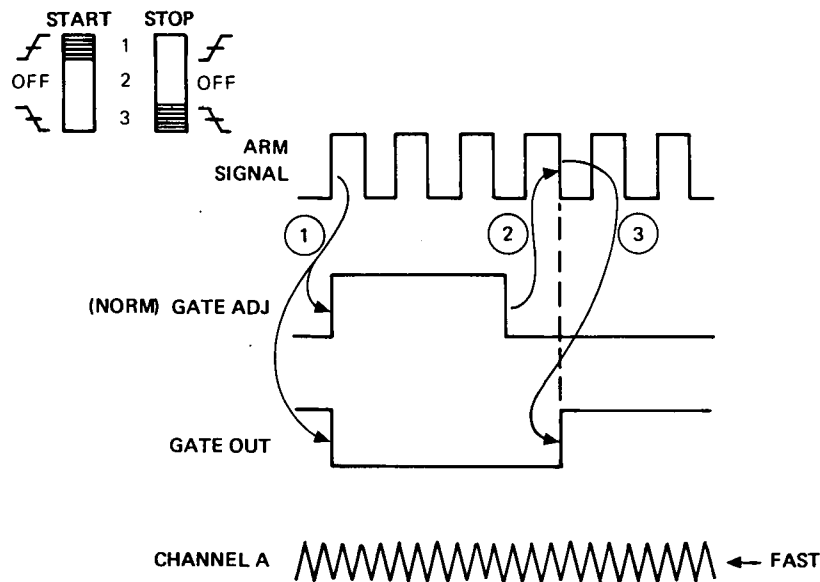

3-93. DETAILED OPERATING INSTRUCTIONS

3-94. The following paragraphs provide detailed operating information. Within a specific function mode, (e.g., **FREQ A**, **PER**) a considerable amount of flexibility is present for both the type of input signal and measurement technique. The intent of the following paragraphs is to provide an instructional discussion, which demonstrates the *user control flexibility* for each major function mode. These operating guidelines should assist in making the most useful and accurate measurement possible.

3-95. **FREQ A**

3-96. The **FREQ A** mode makes measurements on frequencies up to 200 MHz through the Channel A INPUT. In this function the input is prescaled by two, however, there is no loss of resolution. On power-up, the 5335A assumes the **FREQ A** function with the **GATE MODE** in **NORM**. For a cw signal connected to INPUT A (and within the restrictions set by the input signal conditioning controls) the counter is self-arming, and measurements begin immediately. The displayed resolution is adjusted with the **GATE ADJ** control.

3-97. Suppose you need to measure a **pulsed frequency**. Assuming no transients occur before the pulse, the frequency of this signal is measured by setting the **GATE MODE** to **FAST**, and adjusting for a gate time just under 200 μ s. The **INPUT A** controls are set to ac coupling, separate, with the trigger level control at **PRESET**. The counter is armed by the signal, and the gate opens automatically just after the start of the pulse.

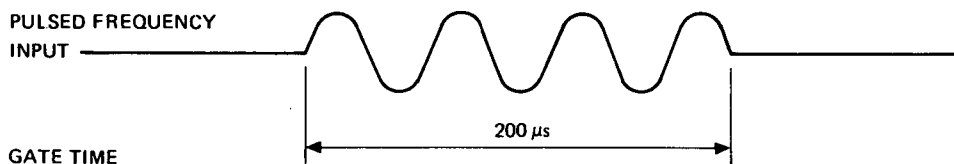

3-98. To measure the frequency at various points along a **chirp**, use the 5335A's arming capability. By setting the **START ARM** slope to positive and the **STOP ARM** slope to negative, and then turning **EXT ARM ENABLE** on, the frequency at various points can be measured. Use an external timing generator to produce the external arm signal.

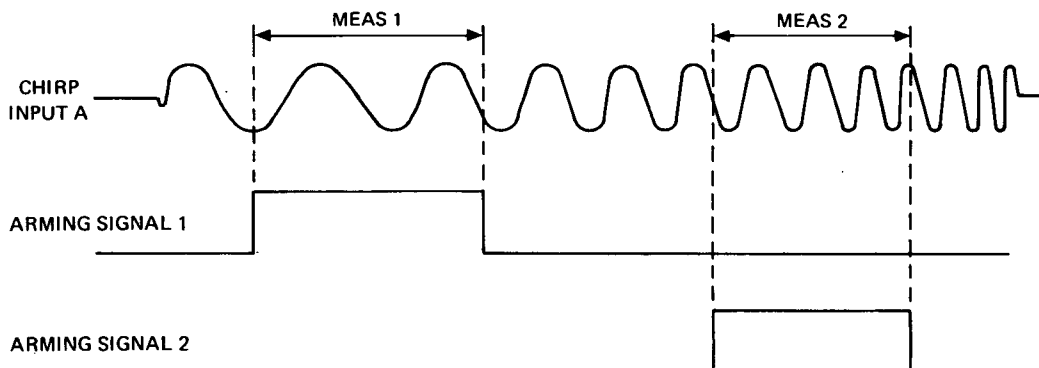

3-99. If the timing generator cannot provide a pulse width of the appropriate width, the **STOP ARM** can be turned off, which lets the counter stop arm itself. With this setup, you can specify any gate time from 100 μ s on up. With **GATE MODE** in **MIN**, the counter will measure the frequency based on two periods of the input.

3-100. To measure the frequency of a **pulsed stream**, use the AUTO TRIG mode and dc coupling. AC coupling these types of signals tends to distort them slightly, due to the charging of the coupling capacitor. Additionally, the position of the signal on the zero preset trigger level is determined by the average dc level of the input. Depending on the pulse width and duty cycle, this dc average may be low enough to allow the base line noise to trigger the counter, producing extra counts.

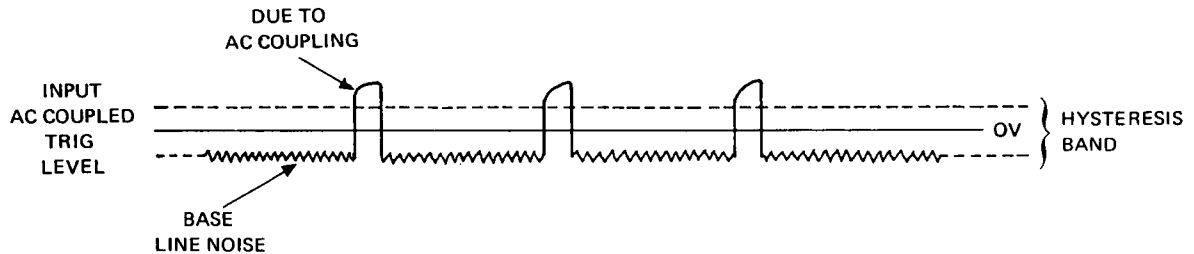

3-101. DC coupling “fixes” the dc level of the input signal. Using AUTO TRIG in Preset or Adjustable allows the trigger level to be easily positioned at an optimum point.

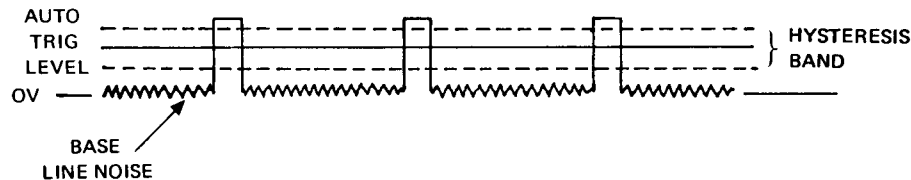

3-102. TIME A → B

3-103. The TIME A→B mode measures the time interval between a start signal at Channel A and a stop signal at Channel B. The START and STOP slopes, as well as trigger levels, are individually selectable. If the START and STOP signals are to be derived from a single signal, set the INPUT SEPARATE/COMMON key to COM A.

3-104. When TIME A→B is selected, the 5335A automatically shifts the GATE MODE from NORM to MIN (NO DELAY). If a “delay” (stop channel prevented from triggering for a specific period of time) is desired, the NORM, FAST, or MANUAL gate modes may be selected. When the delay is active, the red DELAY indicator will light.

3-105. For a simple **time interval measurement** with both slopes set to positive, the counter will display the time period illustrated above. If the signals are not repetitive, be sure that AUTO TRIG is off.

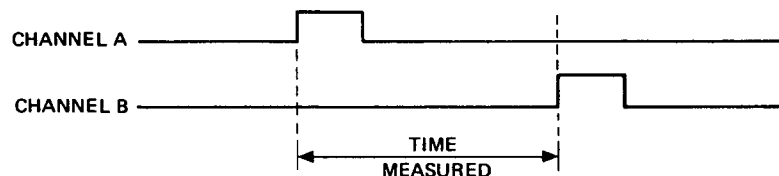

3-106. To measure a specific **rise time manually**, set both slopes to positive and set the INPUT SEPARATE/COMMON key to COM A. Setting the trigger levels to the desired points is simplified by using AUTO TRIG, however, the input signal to Channel A should be continuous. The selected trigger levels may be viewed by pressing the TRIG LVL key, or monitoring the rear panel trigger level outputs. For rise time measurements using the 10% and 90% points, see RISE TIME A.

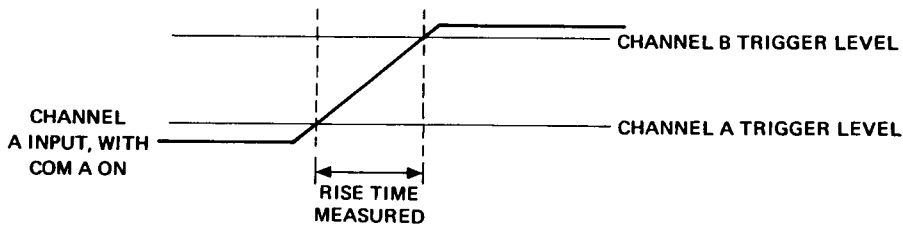

3-107. The **T.I. DELAY** mode is useful for making time interval measurements on signals, where false triggering (due to settling time, relay contact bounce, etc.) must be avoided. To insert a delay, set the GATE MODE to FAST (for a delay range of 100 μ s to 20 ms) or NORM (for a delay range of 20 ms to 4 s) and use the GATE ADJ control to select the required delay.

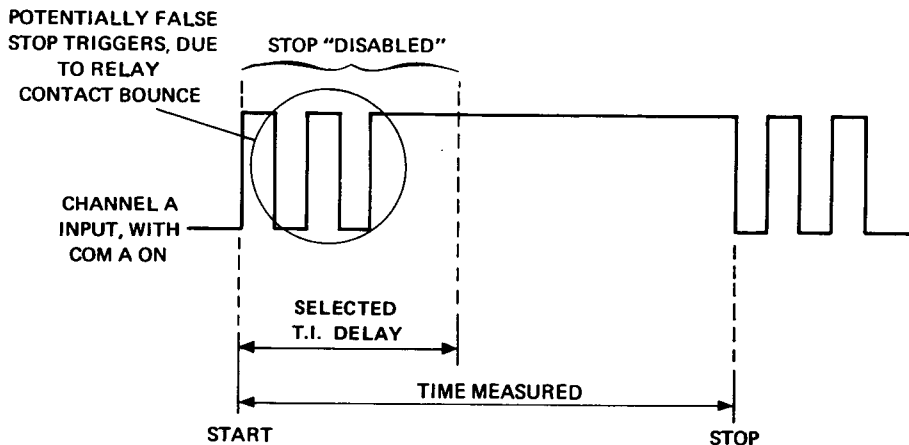

3-108. To measure the time interval between two arbitrary pulses in a **pulse train**, use the counter's external arming capability. Set the External Arm Start switch to select the starting pulse. Generate the arming signal from a timing generator. If the pulse width of the generator is programmable, you can also use this signal to specify the second pulse. If not, you may be able to use the stop hold-off delay feature described in the previous example.

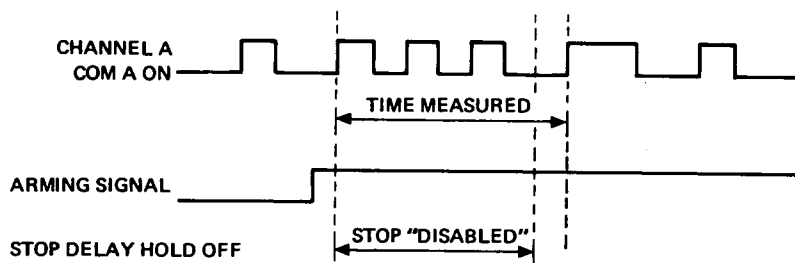

3-109. TOT A

3-110. The TOT A mode will display the number of counts (events) received in Channel A. When TOT A is selected, the 5335A will automatically shift the GATE MODE from NORM to MANUAL, with the Gate initially closed. Pressing the MANUAL key opens the Gate and allows counts to accumulate. To stop counting, press the MANUAL key again. Pressing the MANUAL key once more allows counting to continue without resetting the previous total. To zero the count, press RESET. To begin a new measurement, close the gate and then press RESET. RESET is independent of the Gate.

NOTE

SMOOTH and MATH operations using "MEAS_{t-1}" will not operate in manual totalize.

3-111. In other gate modes TOT A behaves slightly differently. With GATE MODE set to NORM or FAST, the totalize acts somewhat like a frequency measurement. Based on the CYCLE and ARM modes, the totalizing will start and stop without the need for manual operation. Also, between measurements, the count will automatically reset itself.

3-112. To totalize the number of events in a **burst of pulses** which occur at one second intervals, set the GATE MODE to NORM. Adjust the GATE ADJ control for a gate time of just under one-second (≈ 0.8 s). Set CYCLE to MIN. At a one-second rate, the counter will update the display by the number of counts in each burst. The counter will reset and arm itself automatically for each cycle.

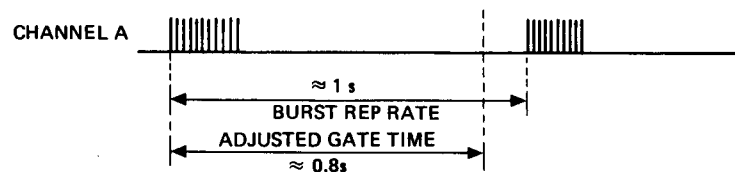

3-113. To totalize the number of events within a **specified window**, connect an externally generated arming signal to the rear panel ARM input. Set the START SLOPE switch to negative and the STOP to positive. Press EXT ARM ENABLE, and the counter will display the number of events within the window. If only the start point is specified by the ARMING signal, you may set the STOP SLOPE switch to OFF, and specify the stop point by putting the GATE MODE into FAST or NORM and setting the GATE ADJ control (as in paragraph 3-107). The SMOOTH and MATH operations can also be used for any totalize GATE MODE except MANUAL.

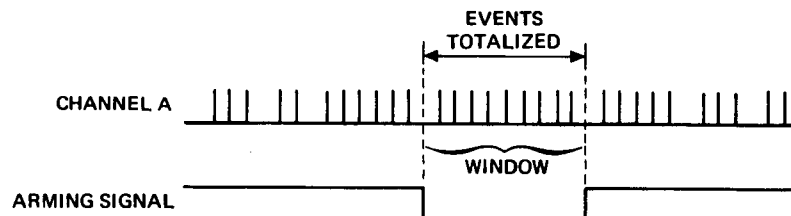

3-114. Normally, the total is not sent to the HP-IB bus until the gate is closed. Some applications call for the total to be sent while the gate is still open and allowing counts. This is called **totalize on the fly**. To totalize on the fly put the counter in Totalize and set the GATE MODE to MANUAL and the CYCLE MODE to SINGLE. Start the count by pressing the MANUAL key. Data will then be sent on the fly during counting and once after the gate is closed. Data is sent only if two successive readings of the counting registers are equal, thus assuring an accurate reading.

If the gate is reopened, data will once again be sent. The output data byte sent while the gate is open is *not* preceded by the Alpha Character "T", while the data sent after the gate is closed is. For further information on the data output format, refer to paragraph 3-191.

NOTE

Totalizing on the fly should be performed only on signals below 50 Hz.

3-115. RATIO A/B

3-116. The RATIO A/B mode allows the measuring of the ratio between two frequencies. The maximum frequency into Channel A is 200 MHz, and into Channel B it is 100 MHz. The ratio is measured by connecting the original frequency into Channel B and the multiplied frequency into Channel A. The counter will display the multiplying factor "N". The number of digits of resolution is determined by the input frequencies and the Gate Time.

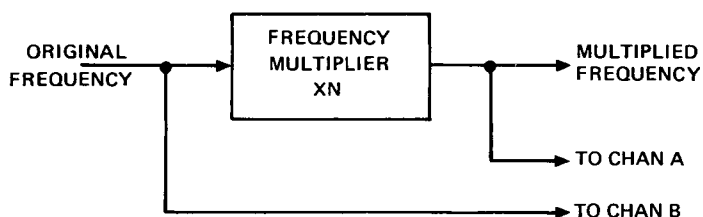

3-117. FREQ C

3-118. The FREQ C mode requires the optional C Channel Input Module. Input signals to INPUT C are prescaled by a-factor-of-20, however, as with FREQ A, there is no loss of resolution. When FREQ C is selected, the Channel A and B INPUT section is disabled. Measurements through C Channel respond to all other controls the same as FREQ A measurement.

3-119. 1/TIME A→B

3-120. The 1/TIME A→B mode performs the standard TIME A→B measurement, mathematically computes the reciprocal value and displays it as units per second. This allows measurement configurations with a direct display of velocity. This mode can also utilize the stop channel delay holdoff (T.I. DELAY) feature, described for TIME A→B.

3-121. To determine the **velocity** of a moving object, connect the START electric eye to Channel A, and the STOP electric eye to Channel B. Select the 1/TIME A→B function. In this example the two electric eyes are 10 metres apart, so compensate by setting SCALE to 10. This will produce a measurement readout in metres/per second. If the ball takes 0.25 seconds to travel between the electric eyes, the answer displayed will be 40 (metres per second). If a 0 ns time is measured, a "0" result will be displayed.

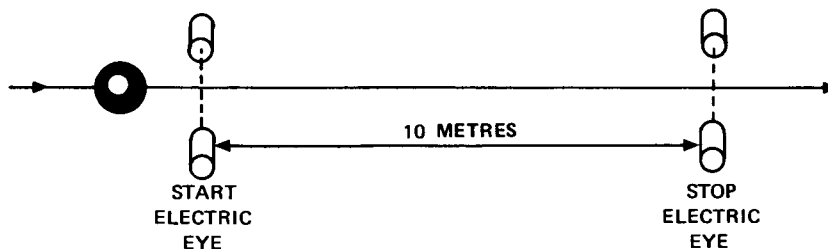

3-122. PULSE A

3-123. The PULSE A mode measures the width of pulses input into Channel A. With the SLOPE A switch set to \nearrow , positive pulses will be measured. With the SLOPE A switch set to \searrow , negative pulses will be measured. This mode can also utilize the stop channel delay holdoff (T.I. DELAY) feature, described for TIME A→B.

3-124. For **continuous pulse streams**, set the trigger level for AUTO PRESET. For **single-shot pulses** or special applications, use the manual modes of triggering. To locate and measure a **selected pulse** within a data stream use external arming. Set the START ARMING SLOPE to positive or negative, when measuring a pulse on Channel A. Position the edge of the Arming Signal just ahead of the leading edge of the desired pulse and set EXT ARM ENABLE to on. Set the trigger level for AUTO PRESET (for most continuous signals) to automatically trigger at the 50% point. The GATE MODE will automatically switch to MIN and a single pulse measurement will be made.

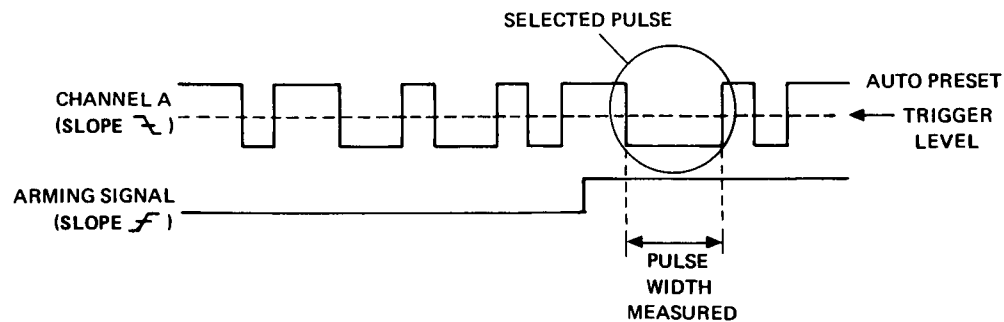

NOTE

Pulse measurements are specified for trigger levels between the 40% and 60% points of the signal.

3-125. RATIO C/A

3-126. The RATIO C/A mode is similar to the RATIO A/B mode (paragraph 3-115), with the advantage of an extended frequency range for ratio measurements. The maximum frequency into Channel A is 200 MHz, and into C Channel it is 1300 MHz. Connect the higher of the two frequencies to the C Channel Input and select the RATIO C/A mode. The ratio will be displayed with the resolution being determined by the higher frequency and the selected Gate Time.

3-127. PER A

3-128. The PER A mode allows single period measurements or multiple period averages to be made on input signals into Channel A. In this mode, the input is not prescaled so the maximum frequency is 100 MHz. In NORM/FAST GATE MODES, a **period average** measurement is made where the number of periods averaged is determined by the setting of the GATE ADJ control and the period of the signal. For **single period** measurements, set the GATE MODE to MIN.

3-129. RISE/FALL A

3-130. The RISE/FALL A mode automatically configures the counter to perform either rise or fall time measurements. The input is automatically set to COM A and triggering to AUTO TRIG. In this mode, AUTO TRIG automatically locates and sets the trigger levels at the 10% and 90% points of the input signal. **Rise time** measurements are made when the SLOPE A control is set to \nearrow . **Fall time** measurements are made when the SLOPE A control is set to \searrow . For rise and fall measurements, the input signal must be continuous. To measure the rise time on a **selected slope**

of a signal, use external arming. Set the Start Arming Slope to positive and using an oscilloscope, position the leading edge just ahead of the selected slope of the signal. With SLOPE A positive, the counter will display the rise time; with SLOPE A to negative, the counter will display the fall time. Measurements are displayed in units of seconds.

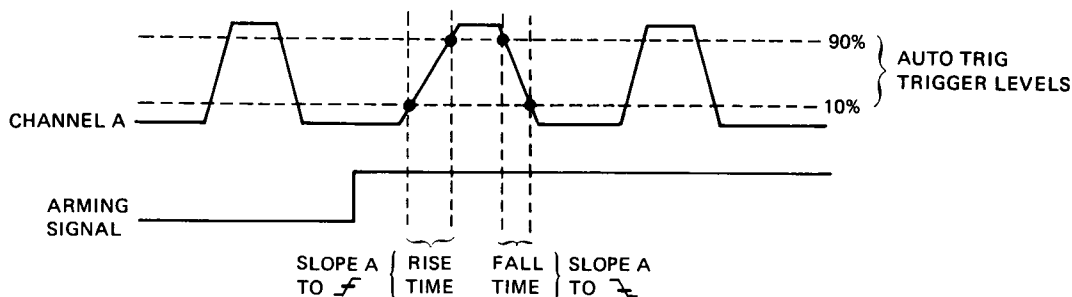

3-131. SLEW A

3-132. The SLEW A mode is similar to the RISE/FALL A mode, with the counter automatically selecting COM A and AUTO TRIG. However, to more easily accommodate analog signals, the measurement is displayed in units of Volts/seconds. Additionally, the MATH operations may also be selected to achieve a direct readout of the desired units. For example, programming the NORMLZ function with values of 10^3 or 10^6 will produce slew rates in units of volts/millisecond and volts/microsecond, respectively. As with RISE/FALL A, the measurements with SLEW A are with respect to the 10% and 90% points of the input and the input must be continuous. Also, slew rates on **selected slopes** may be made, using the external arm method.

3-133. DUTY CYC A

3-134. The DUTY CYC A mode measures and displays the proportional percentage of either the positive or negative durations of a given input digital waveform. The percentage of the positive pulse is given when the SLOPE A control is set to \nearrow . The percentage of the negative pulse is given with the control set to \searrow . In this mode, the counter automatically sets the GATE MODE to MIN.

3-135. Duty cycle is actually measured indirectly through two measurements, Period and Pulse. Therefore, the signal should have a constant duty cycle in order to be accurately measured. If a particular place in a pulse stream needs to be examined in a changing duty cycle environment, be sure that the characteristics are repetitive.

3-136. To measure the positive duty cycle of a **continuous asymmetrical waveform**, select DUTY CYC A, set the SLOPE A control to \nearrow and set triggering to Auto Preset. The counter will display a value, typically between 1 and 99 ("25" in this example) representing the duty cycle. No unit annunciators will light, as duty cycle is assumed as "percentage".

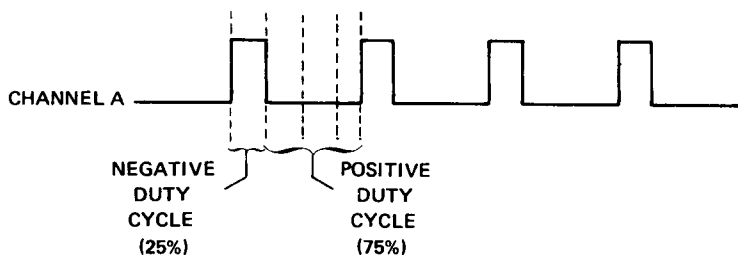

NOTE

Duty Cycle should be measured with the trigger level set between the 40% and 60% points of the signal peaks.

3-137. GATE TIME

3-138. The GATE TIME mode provides an indication of the length of the gate time, displayed to three significant digits. When EXT ARM ENABLE is on, gate time resolution to 100 ns is displayed. The gate time is controlled (except in MIN) by the GATE ADJ control.

NOTE

As the gate is synchronized to the input signal, the actual gate time may be different from the displayed gate.

3-139. When in a TIME domain function mode (e.g., TIME A→B, PULSE A), the GATE TIME mode provides an indication of the amount of **stop delay time** selected. This time is set by the GATE ADJ control. When in a TIME domain function, with the GATE MODE in NORM or FAST, the T.I. DELAY indicator will be lighted.

3-140. Pressing GATE TIME does not affect the function set-up memory of the operating mode. Press the operating mode function key or reset to resume measurements.

3-141. TRIG LVL

3-142. The TRIG LVL mode displays both the Channel A and B trigger levels. The grouping on the left is Level A and the right is Level B. If the operating function mode, prior to the TRIG LVL, was RISE/FALL or SLEW, the levels displayed will be the 10% and 90% points of the input signal. For PHASE A rel B, the levels will be the 50% points. Pressing TRIG LVL does not affect the function set-up memory of the operating mode. Press the operating mode function key or reset to resume measurements.

3-143. When outputting the Channel A and B Trigger Levels, via the HP-IB, two complete numbers are sent, prefixed with the letters A and B.

3-144. VOLTS

3-145. The VOLTS mode requires the option 020 DVM input module. The DVM is fully floating and autoranging. A unique feature is that there is no need for predetermined gate times. This means that, like frequency, you may gate time to most any setting desired. Also, this means that you can arm both the start *and* the stop of a voltage measurement.

3-146. To measure the voltage of a signal at a **specified point**, use external arming. Set the start arm switch to positive and the stop arm switch to negative. Position the arming signal to allow for the step response time of the voltmeter (t_1). For environments with 50 or 60 Hz noise problems, gate time which are multiples of 100 ms will reduce error in the measurements.

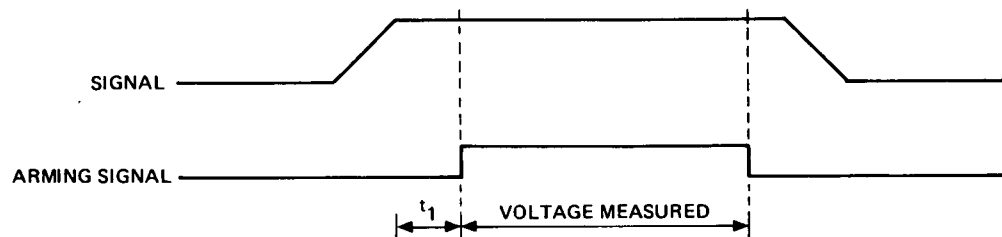

3-147. PHASE A rel B

3-148. The PHASE mode measures the phase of the signal on Input A, relative to the signal on Input B. The phase difference is displayed in degrees. In this mode, Auto Preset triggering is automatically selected. The trigger points are set to the 50% points of each signal, regardless of either signal's offset.

3-149. The overall display range is -180° to $+360^\circ$. The display of a PHASE measurement is configured such that around 0° , the operating range is -180° to $+180^\circ$, but around $+180^\circ$ the operating range is 0° to 360° . If RANGE HOLD is on, the range is fixed to 0° to 360° . The PHASE mode cannot be externally armed.

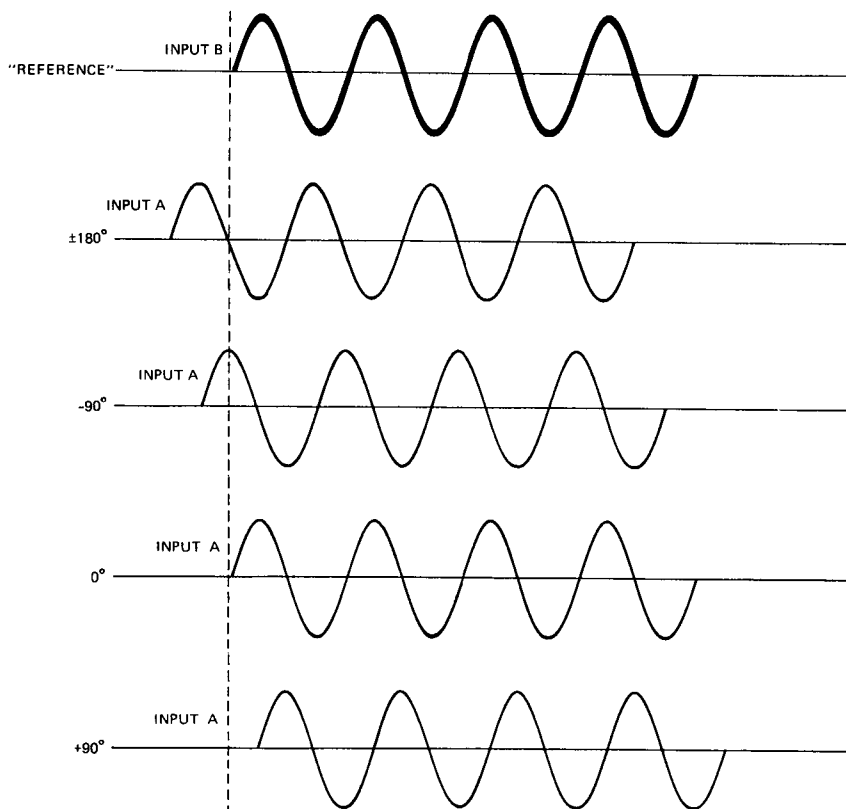







3-150. Phase measurements are made through a series of individual measurements, therefore certain input and operational restrictions apply:

- The frequency and phase angle of the signals should be constant.
- Frequencies can be measured up to 1 MHz.
- PHASE A rel B measurements should be made with the SEP/COM switch in SEP. If COM A is momentarily selected, the RESET key should be pressed.
- RESET should be pressed after any change to the INPUT controls, particularly for SLOPE and SEP/COM controls.

NOTE

Because phase requires a steady signal input, the use of statistics is not valid (i.e., the STD DEV of a steady signal should be \emptyset , and the MEAN should be the same as any one measurement). Therefore, the use of STATISTICS for PHASE measurements is not recommended.

Table 3-2. Function Key Reference Summary

FUNCTION KEY	UNITS	TRIG MODE	SLOPE A USAGE	ARMING	GATE ADJ	COMMENTS
FREQ A	Hz	Any		Yes	Gate	Prescaled-by-2
TIME A→B	s	Any		Yes	Stop Delay	
TOT A	---	Any		If not in manual	Gate	Smooth and MEAS _{t-1} will not operate when in MANUAL
RATIO A/B	---	Any		Yes	Gate	
FREQ C	Hz	N.A.	N.A.	Yes	Gate	Prescaled-by-20
1/TIME A→B	1/s	Any		Yes	Stop Delay	
PULSE A	s	Any	 = Positive Pulse  = Negative Pulse	Yes	Stop Delay	
RATIO C/A	---	Any		Yes	Gate	"A" prescaled-by-2, "C" prescaled-by-20
PER A	s	Any		Yes	Gate	
RISE/FALL A	s	10%, 90%	 = Rise Time  = Fall Time	Yes	MIN only	Signal should be >50 Hz and <25 MHz.
SLEW A	V/s	10%, 90%	 = Rising Slope  = Falling Slope	Yes	MIN only	Signal should be >50 Hz and <25 MHz.
DUTY CYC A	s	Any	% High symbol" data-bbox="415 415 435 435"/> = % High % Low symbol" data-bbox="415 435 435 455"/> = % Low	No	MIN only	Needs constant signal
GATE TIME	s	N.A.		Yes	Shows Gate or Stop Delay	Will not affect function memory
TRIG LVL	V	Follows Last function	N.A.	N.A.	N.A.	Will not affect Function memory, send 2 numbers on HP-IB
VOLTS	V	N.A.	N.A.	Yes	Gate	
PHASE A rel B	°	50%		No arming	MIN only	Needs constant signal. Range 0° to 360° if RANGE HOLD on >30 Hz

3-151. PROGRAMMING

3-152. Introduction

3-153. The 5335A Universal Counter is fully compatible with the Hewlett-Packard Interface bus (HP-IB). The bus capability is installed as standard equipment and allows the counter to respond to remote control instructions and output measurement results via the HP-IB. At the simplest level, the 5335A can output data to other devices such as the 5150A Thermal Printer or the 59303A Digital-to-Analog Converter. In more sophisticated systems, a computing controller or other controllers can remotely program the 5335A to perform a specific type of measurement, trigger the measurement, and read the results.

NOTE

HP-IB is Hewlett-Packard's implementation of IEEE Std. 488-1978, "Standard Digital Interface for Programmable Instrumentation".

3-154. This section describes how to use the 5335A on the HP-IB. Before programming, the operator must be familiar with the selected computing controller (e.g., the 9825A, 9830A, or 9835/45A calculators), the capabilities of the HP-IB, and the manual operation and capabilities of the 5335A. The following HP manuals provide useful background information:

- HP-IB User Guide, 9830A (P/N 59300-90002)
- Hewlett-Packard 9825A Calculator General I/O Programming (P/N 09825-90024)
- Hewlett-Packard 9825A Calculator Extended I/O Programming (P/N 09825-90025)
- Condensed Description of the Hewlett-Packard Interface Bus (P/N 59401-90030)
- Abbreviated Description of Hewlett-Packard Interface Bus (P/N 5955-2903)
- HP-IB Quick Reference (P/N 5955-2902)

3-155. Interface Function

3-156. The capability of a device connected to the bus is specified by its interface functions. Table 3-3 lists the 5335A Interface Functions using the terminology of the IEEE 488-1978 standard. These features are also listed below the rear panel HP-IB connector, as follows:

SH1, AH1, T1, TE0, L2, LE0, SR1, RL1, PP0, DC1, DT1, C0

Table 3-3. HP-IB Interface Capability

INTERFACE FUNCTION SUBSET IDENTIFIER	INTERFACE FUNCTION DESCRIPTION
SH1	Complete source handshake capability.
AH1	Complete acceptor handshake capability.
T1	Talker (basic talker, serial poll, talk only mode)
TE0	No extended talker capability.
L2	Listener (basic listener, no listen only mode, does not unaddress to listen if addressed to talk).
LE0	No extended listener capability.
SR1	Service request capability.
RL1	Complete remote/local capability.
PP0	No parallel poll capability.
DC1	Device clear capability.
DT1	Device trigger capability.
C0	No controller capability.

3-157. The number following the interface function code indicates the particular capability of that function as listed in Appendix C of IEEE Std. 488-1978. Interface functions provide the means for a device to receive, process, and send messages over the bus.

3-158. Nearly all controls on the 5335A can be programmed remotely, and data from measurements can be sent to other devices through the HP-IB. The TALK, LISTEN, SRQ, and REMOTE annunciators in the display will indicate the state of the instrument. The following paragraphs describe the basic programming capability of the 5335A Universal Counter.

TALK: When addressed as a Talker, whether by a controller or by the TALK ONLY switch, the 5335A will try to send data out to other devices on the bus. Normally this data is the measurement data.

LISTEN:	When addressed as a Listener, the instrument can accept any number of commands from a controller on the bus. These commands will usually be used to program the instrument operation.
SERVICE REQUEST:	SRQ can be sent out to the bus at the end of measurements and on error or failure messages. Normally SRQ is inhibited, but certain commands will enable this feature. See "WA" and "SR".
REMOTE/LOCAL:	Normally the 5335A is under local control. In order to program the instrument it must be in Remote. Once in Remote, all programmable controls are in remote and cannot be affected by manual command. The RESET key may be used to manually return to local control only if Local Lockout is OFF. If Local Lockout is ON, the RESET key is ignored.
PARALLEL POLL:	No parallel poll capability in the 5335A.
DEVICE CLEAR:	When a universal or selected device clear is received, the instrument clears out all input buffers and resets the hardware for a new measurement. The display will flash momentarily. SRQ is also cleared. Device clear can be used to clear an ERROR message.
DEVICE TRIGGER:	When a device trigger is received, a new measurement is started.
CONTROLLER:	No controller capability in the 5335A.

3-159. Bus Messages

3-160. Messages are the means by which devices exchange control and measurement information. There are 12 basic messages which can be sent over the interface. *Table 3-4* lists each bus message, a description of the message, how the 5335A uses that message, and examples of the various controller's implementation of the messages.

3-161. Address Selection

3-162. To use the 5335A in an HP-IB system, first set the rear panel address switches as shown in *Table 3-5*. The leftmost switch sets the counter to the ADDRESSABLE mode or the TALK ONLY mode. ADDRESSABLE mode is used whenever a calculator or other controller is used with the system. TALK ONLY mode is used when the counter is operating under its own control (no controller on bus) and outputs its measured result to another device on the bus, such as a printer.

3-163. The five righthand switches, A₅ through A₁, set the talk and listen addresses of the 5335A when it is used in the ADDRESSABLE mode. *Table 3-5* shows the possible address settings and the corresponding ASCII codes for talk and listen.

3-164. The examples listed in this section assume an address setting of 00011, which is a 5-bit binary code for the decimal number three. This number is important when using an HP 9825A, 9835A, or 9845A calculator, since the calculator addresses the 5335A to talk and listen by using the code 703. (The "03" being the 5335A address.) The ASCII characters for this same switch setting are "C" for a talk address and "#" for a listen address. These characters are used when the computing controller is an HP 9830A calculator.

Model 5335A
Operation and Programming

Table 3-4. 5335A Bus Message Usage

Message	Description	5335A Use	Sample 9825 Statements (5335A Set to Address 03)	Sample 9835/45 Statements (5335A Set to Address 03)
Data	Transfers device-dependent information from one device to one or more devices on the bus.	Sends measurement data. See paragraph 3-191 for output format. Accepts program codes. See Table 3-6 for code set.	red 703, A wrt 703, "FN9"	ENTER 703, A OUTPUT 703, "FN9"
Trigger	Causes a group of selected devices to simultaneously initiate a set of device-dependent actions.	Starts a new measurement.	trg 7 or trg 703	TRIGGER 7 or TRIGGER 703
Clear	Causes an instrument to be set to a predefined state (a certain range, function, etc.)	Sames as front panel RESET. Clears internal count and starts new measurement. Clears any Error condition.	clr 7 or clr 703	CLEAR 7 or CLEAR 703
Remote	Permits selected devices to be set to remote operation, allowing parameters and device characteristics to be controlled by Bus Messages.	Causes counter to go to remote operation if REN is true and counter is addressed to listen. In absence of program data, remote operation is according to state of front panel settings just prior to going to remote. Locks out all pushbuttons except Local	rem 7 or rem 703	REMOTE 7 or REMOTE 703
Local	Causes selected devices to return to local (front panel) operation.	Goes to local front panel control. In absence of front panel data, local operation is according to the state of the remote data just prior to going to local. The following states are invoked; WA0, DR0, and SR0.	lcl 7 or lcl 703	LOCAL 7 or LOCAL 703
Local Lockout	Disables local (front panel) controls fo selected devices	Disables front panel RESET. 5335A remains in remote	llo 7	LOCAL LOCKOUT 7 or LOCAL LOCKOUT 703
Clear Lockout and Local	Returns all devices to local (front panel) control and simultaneously clears the Local Lockout Message.	Local Lockout cleared and returns to local front panel control.	lcl 7 or lcl 703	LOCAL 7 or LOCAL 703
Require Service	Indicates a device's need for interaction with the controller.	Used to flag an error or fail condition or indicate one of several instrument specific messages coded in status byte	rds(7)→A if bit (7, A) (bit 7=1 if SRQ true)	STATUS 703; A
Status Byte	Presents status information of a particular device; one bit indicates whether or not the device currently requires service, the other 7 bits (optional) are used to indicate the type of service required.	Bit 7 is set if service is re-requested. Additionally, Bit 1, 2, 3, 4, 6, 7, or 8 may be set, indicating a specific instrument condition or status, see Table 3-7.	rds(7)→A or rds(703)→A	STATUS 703; A FOR I=7 TO 0 STEP - 1 PRINT I: BIT (A, I) NEXT I END (sample program prints status of Bits 1 through 8)
Status Bit	A single bit of device dependent status information which may be logically combined with status bit information from other devices by the controller.	Does not use	—	—
Pass Control	Passes bus controller responsibilities from the current controller to a device which car assume the Bus supervisory role.	Does not use	—	—
Abort	Unconditionally terminates Bus communications and returns control to the system controller.	Clears Talk, Listen, Serial Poll Enable registers on 5335A HP-IB Interface. Front panel set-up does not change.	cli 7 or cli 703	ABORTIO 7

SWITCHES SHOWN WITH
ADDRESS = 03.

Table 3-5. HP-IB Address Switch Selections

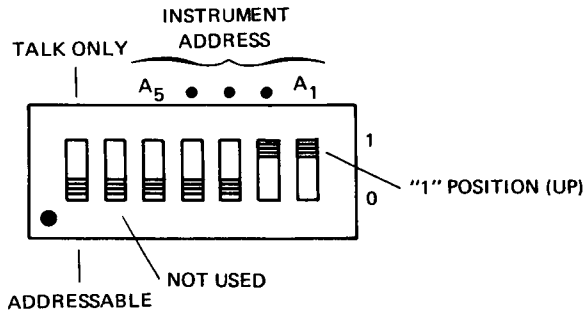

NOTE: THE TALK ONLY SWITCH SHOULD BE CHANGED ONLY WHEN THE INSTRUMENT IS OFF.

ASCII CODE CHARACTER		ADDRESS SWITCHES					DECIMAL EQUIVALENT OF BINARY SWITCH SETTING
LISTEN	TALK	A ₅	A ₄	A ₃	A ₂	A ₁	
SP	@	0	0	0	0	0	00
!	A	0	0	0	0	1	01
"	B	0	0	0	1	0	02
#	C	0	0	0	1	1	03
\$	D	0	0	1	0	0	04
%	E	0	0	1	0	1	05
&	F	0	0	1	1	0	06
'	G	0	0	1	1	1	07
(H	0	1	0	0	0	08
)	I	0	1	0	0	1	09
*	J	0	1	0	1	0	10
+	K	0	1	0	1	1	11
,	L	0	1	1	0	0	12
-	M	0	1	1	0	1	13
.	N	0	1	1	1	0	14
/	O	0	1	1	1	1	15
Ø	P	1	0	0	0	0	16
1	Q	1	0	0	0	1	17
2	R	1	0	0	1	0	18
3	S	1	0	0	1	1	19
4	T	1	0	1	0	0	20
5	U	1	0	1	0	1	21
6	V	1	0	1	1	0	22
7	W	1	0	1	1	1	23
8	X	1	1	0	0	0	24
9	Y	1	1	0	0	1	25
:	Z	1	1	0	1	0	26
;	[1	1	0	1	1	27
<	\	1	1	1	0	0	28
=]	1	1	1	0	1	29
>	~	1	1	1	1	0	30

3-165. Device Command Definitions

3-166. A device command is a sequence of two or more ASCII-coded bytes, sent to the 5335A over the HP-IB, that causes the counter to perform a specific function. Before discussing individual device commands, it is useful to classify these commands into five types:

1. **Numeric Command:** *Type N*; A sequence of two ASCII-coded bytes followed by a sequence of bytes representing a decimal number and a terminator. A terminator is either a comma, semicolon, space, carriage return, or line feed. A Termination may also be implied with the start of the next command. For a numeric command, the entry must follow the following format:

<N spaces> [sign] <J digits> [.<K digits>] [E [Sign] <L digits>]

where:

N=0 to any value

J=1 to 12

K=0 to 11

L=1 or 2

and:

J+K ≤ 12

Absolute value of number <10¹⁰. If more than 12 digits are received, they are ignored.

The following commands are equivalent:

9825A

wrt 703, "RE, MS 123456"
wrt 703, ;"REMS+1.23456E+05"
wrt 703, "RE, MS123.456E3"

123456→A; wrt "RE MS", A
wrt 703, "RE, MS123.456E3"

9835A/45A

OUTPUT 703; "RE, MS 123456"
OUTPUT 7,3; "REMS+1.23456E+05"
OUTPUT 703; "RE, MS123.456E3"
Scale = 123456
OUTPUT 703; "RE MS", Scale
OUTPUT 703; "RE, MS123.456E3"

2. **Binary Command:** *Type B*; A sequence of two ASCII-coded bytes followed by either a 0 or a 1. The 0 indicates the selected function if "OFF" or "FALSE", and the 1 (or any non-zero value) indicates "ON" or "TRUE". The binary command uses the same format as numeric commands. The following are binary commands:

wrt 703, "WA1"	TRUE	OUTPUT 703; "WA1"
wrt 703, "WA0"	FALSE	OUTPUT 7,3; "WA0"
wrt 703, "WA123"	TRUE	OUTPUT 703; "WA123"
		True = 1
1→A; wrt 703, "WA", A	TRUE	OUTPUT 703; "WA", True

3. **Integer Commands:** *Type I*; A sequence of two ASCII-coded bytes followed by a sequence of bytes representing a decimal number and a terminator. For integer commands, negative number are converted to their absolute values. If the number is outside the expected range, the parameter is converted to zero. The integer command uses the same format as numeric commands. The following commands are equivalent:

9825A

wrt 703, "CY2"
wrt 703, "CY-2"
wrt 703, "CY 0.2E+1"

9835A/45A

OUTPUT 703; "CY2"
OUTPUT 703; "CY-2"
OUTPUT 703; "CY0.2E+1"

4. **Terse Commands:** *Type T*; A sequence of two ASCII-coded bytes not followed by a numeric or binary number. Requests a specific function or subroutine to be executed. For example, the characters "IN" will cause the counter to **IN**itialize all control settings to default status.
5. **Special Commands:** *Type **; A sequence of two ASCII-coded bytes followed by a sequence of bytes representing some defined value. For example, the characters "MOD" will program the **Math Offset** to the value of the last **Display**.

3-167. The 5335A DEVICE COMMANDS

3-168. Almost every control on the 5335A can be programmed via the HP-IB. Programming is accomplished by addressing the counter as a listener and sending it device commands. *Table 3-6* shows the complete set of device commands. The commands are organized into functional groups for ease of description and use.

3-169. Commands may be sent upper or lower case. To separate commands, you may use nothing at all or you may use any combination of spaces, commas, semicolons, carriage returns, and line feeds. Spaces are not allowed within a command name. At least one of the separation characters must follow the end of command strings. Usually this is the carriage return and line feed characters sent automatically by a write statement. For example, the command:

9825A	9835A/45A
wrt 703, "RE"	OUTPUT 703; "RE"

addresses the counter as a listener and sends it the command to reset. The "wrt" (and OUTPUT) instruction automatically follows the "RE" with a carriage return and a line feed. The one exception to most of these rules is binary programming, which uses the "wtb" (or WRITE BIN) instruction. For further information on binary programming refer to Learn Mode Programming, paragraph 3-181.

3-170. Function Selection FU, FN

3-171. This selects the function. Functions 1 through 16 are the normal functions found on the front panel. Functions above 16 are special functions (see Special Functions). These are provided to enhance system measurements. **FU99** accesses the diagnostic mode. Diagnostics are covered in Section VIII.

3-172. Gate Time Setting GA, GO, GC

3-173. This GA command is used to set the gate time remotely. The range of times is from about 1 ms to about one second. Resolution of the setting is about 2 ms, and accuracy is about 2% ± 2 ms. For programmed gate times greater than one second, use GO and GC, to open and close the gate "manually":

9825A	9835/45A
wrt 703, "GO"	OUTPUT 703; "GO"
WAIT 30000	WAIT 30000
wrt 703; "GC"	OUTPUT 703; "GC"

This can be useful for totalizing and for extremely long gate times.

NOTE

The 5335A makes no distinction between the GO and GC command. Each time either of these two are received the 5335A treats it like the pressing of MANUAL Gate Mode key.

Table 3-6. 5335A Device Commands (Continued)

Command Group	Equivalent Key/Control	Description	Command Type	Device Command
GATE	GATE ADJ GATE OPEN GATE CLOSE	Set GATE TIME 1 ms to one second	N	GA<#>
			T	GO
			T	GC
	GATE MODE	Set GATE MODE to NORM Set GATE MODE to FAST Set GATE MODE to MIN Set GATE MODE to MANUAL	I	GM0
			I	GM1
			I	GM2
			I	GM3
CYCLE	CYCLE MODE	Set CYCLE to NORM Set CYCLE to MIN Set CYCLE to SINGLE	I	CY1
			I	CY2
			I	CY3
INPUT	SLOPE A	Set SLOPE A POSITIVE Set SLOPE A NEGATIVE	B	AS0
			B	AS1
	SLOPE B	Set SLOPE B POSITIVE Set SLOPE B NEGATIVE	B	BS0
			B	BS1
	PRESET A	Set PRESET A off Set PRESET A on	B	AP0
			B	AP1
	PRESET B	Set PRESET B off Set PRESET B on	B	BP0
			B	BP1
	COM A	Set COM A off Set COM on	B	CO0
			B	CO1
AUTO TRIG	Set AUTO TRIG off Set AUTO TRIG on	B	AU0	
		B	AU1	
REAR	EXT START	External START Arm Slope Positive External START Arm off External START arm Slope Negative	I	XA1
			I	XA2
			I	XA3
	EXT STOP	External STOP Arm Slope Positive External STOP Arm Off External STOP Arm Slope Negative	I	XO1
			I	XO2
			I	XO3
DISPLAY	DISP REMOTE	Set display to NORMAL Set Display to REMOTE (blank display)	B	DR0
			B	DR1
	DISP DATA	Display data (with display in Remote)	N	DI<#>
BINARY	Request	Request 30 byte binary status Request 30 byte binary status	T	P?
			T	PQ
	Program	Program with binary status	*	PB<*>
MISC	Wait	WAIT to send mode off WAIT to send mode on	B	WA0
			B	WA1
	SRQ	Service Request disabled Service Request enabled	B	SR0
			B	SR1
INITIALIZE	Initialize everything to default	T	IN	
	INTERPOLATOR	Interpolator enable Interpolator disabled	B	ID0
			B	ID1
	RESET	Reset instrument for new measurement.	T	RE
	RANGE HOLD	Set RANGE HOLD off Set RANGE HOLD on	B	RH0
			B	RH1
	EXT ARM EN	Set EXT ARM EN off Set EXT ARM EN on	B	XE0
			B	XE1
	CHECK	Start CHECK*	T	CH

*When selecting the CHECK function via the HP-IB, the HP5335A must NOT be in the "GA" (Gate Adj) function or a "FAIL 4.4" will result.

3-174. Remote Display DR0, DR1, DI

3-175. This command lets you write to the display remotely. When DR1 is sent, the display can be written to by the DI command. For example, the command:

9825A	9835A/45A
wrt 703, "DR1, DI12345"	OUTPUT 703; "DR1, DI12345"

causes the number given by the DI command (12345) to be formatted into engineering notation and displayed. With the display in remote, normal measurements can still be programmed, executed and output through the HP-IB, but the results will not be displayed.

3-176. Default States

3-177. The default state is equivalent to sending all commands with a parameter of zero. This may be different from the power-up state for controls that are found on the rear panel and for the INPUT section on the standard front end, due to the use of detented, not momentary, switches.

3-178. For integer type commands (Type I) the default states are as follows:

FUNCTION	(FU0 is ignored)	
CYCLE	CY0 equivalent to	CY1 NORM
EXT START	XA0 equivalent to	XA2 OFF
EXT STOP	XO0 equivalent to	XO2 OFF

3-179. Initialize

3-180. When INitialize is executed, the following states are NOT affected: DR, WA, SR, SO
 The following states will be set:

CHAN A & B PRESET ... ON	FUNCTION	FREQ A
CHAN A & B \mathcal{F}	MATH	OFF
SEP/COM	STATISTICS	OFF
AUTO TRIG	GATE MODE	NORM
EXT ARM	CYCLE MODE	NORM
RANGE HOLD		

NOTE

Do not initialize ("IN") the counter when the display is in remote ("DR1"). Whenever the display is in remote, follow the initialize command with "FU1" (or any other function command). For example: wrt "5335A", "IN, FU1, DR1".

3-181. Learn Mode Programming P?, PQ, PB

3-182. The front panel can be used as the medium by which you tell the controller how to program the counter. This is commonly referred to as Learn Mode programming, or Binary Programming.

3-183. With the instrument in Local, the user is allowed to set up the controls in the MATH, STATISTICS, FUNCTION, GATE MODE and CYCLE groups in any way desired. The controller then sends a PQ command and follows this by receiving 30 bytes of binary program data. Later, when the set up is to be duplicated by the controller, the instrument is sent PB followed by the same 30 bytes of binary data.

3-184. If the data contained in the OFFSET, NORMLZ, and SCALE registers is not needed, the 30 bytes can be shortened to just 7 bytes, thus speeding the programming time. Refer to the Programming Examples beginning with paragraph 3-209.

3-185. SRQ and Status SR

3-186. The 5335A has the ability to send a request service (SRQ) message. To enable this feature, the controller must send the SR1 command.

3-187. Request service may be sent upon any error or fail message, and may be sent at the end of a measurement. When request service is sent the seventh bit (bit 7) is set. In addition to this bit, one other bit is also set, representing the status or type of service requested. If service request is not enabled, this second bit is still set, even though bit 7 is not. Table 3-7 gives the effect of each of the status bits on the service request message. When SRQ is asserted, the 5335A will turn on the "SRQ" annunciator.

3-188. The 5335A will only send SRQ if a measurement is ready for sending, and it is in the WAIT mode, and it is not addressed to TALK or RFD is false.

SRQ if: { (Measurement done)
AND
(in WAIT mode)
AND
[(if not addressed to TALK) or (RFD is false)]

NOTE

Constant reading of the status byte is not recommended. This may slow down the measurement processor time.

Table 3-7. Status Bits Usage with SRQ

SR Status Bits	Usage
BIT 1 (LSB)	Set when measurement is done; and 1) 5335A is in WAIT mode and it is not yet addressed to talk, or 2) 5335A is in WAIT mode and is addressed to talk, but listening device on bus is not yet ready for data (RFD is false).
BIT 2	Set when external time base used.
BIT 3	Set if an ERROR has happened.
BIT 4	Set if a FAIL has happened.
BIT 6	Set when GATE is open.
BIT 7	Set if requesting service.
BIT 8	Set if in diagnostic monitor

3-189. Program Execution/Response Times

3-190. Program speed is dependent upon the 5335A's HP-IB response time. Table 3-8 provides some NOMINAL response times for various types of commands, using the 9825A calculator. The examples use the "wrt" instruction. Times are rounded up to 5 ms resolution.

Table 3-8. HP-IB Response Times

Command Mode	Device Command Code	Nominal Response Time
Function Select	FU1	50 ms
	NOTE For RISE/FALL A, SLEW A, and PHASE allow for AUTO TRIG response time).	
Math Set	MS-123456789e-9	75 ms
	MD1	45 ms
Statistics Set	SN1	45 ms
	SD1	45 ms
	SM1	45 ms
	SS1	45 ms
Reset	RE	30 ms
Range Hold	RH1	45 ms
Ext Arm Enable	XE1	45 ms
	XA2	45 ms
Gate Set	GM1	45 ms
	GA 29.111	60 ms
Cycle Set	CY1	45 ms
Input Set	AS1 and AP1	45 ms
	CO1	45 ms
	AU1	45 ms
Display	DR1	25 ms
	DI-123456789e-9	70 ms
	DR0	45 ms
Initialize	IN	30 ms
Miscellaneous	WA1	45 ms
	SR1	45 ms
	clr (HP-IB clear)	240 ms
	trg (HP-IB trigger)	30 ms
	rds (HP-IB read status)	30 ms
Program Binary	P?	30 ms
	PB (30 bytes)	90 ms
	PB (7 bytes)	40 ms

3-191. Output Format

3-192. After a measurement, the 5335A outputs the data to the HP-IB. The output byte contains 19 characters which are arranged in the following format:

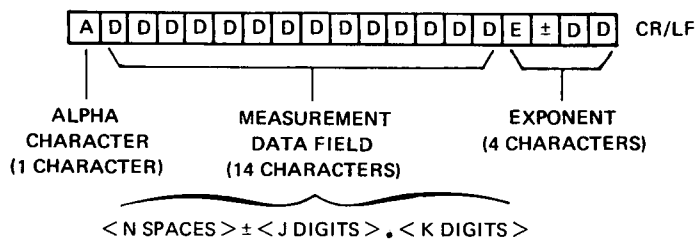

3-193. ALPHA CHARACTER. One of eight single characters which specify the type of measurement. It is generally used to indicate the type of units. The alpha characters are:

- F - precedes Frequency measurements; units of Hz (Hertz)
- S - precedes Time measurement; units of s (seconds)
- V - precedes Voltage measurements; units of V (Volts)
- R - precedes Ratio measurement; no units
- T - precedes Totalize measurements; no units
- sp - precedes 1/TIME, DUTY CYCLE, PHASE; units as specified
- A - precedes A Channel TRIG LVL; units of V (Volts)
- B - precedes B Channel TRIG LVL; units of V (Volts)
- M - precedes MEAN output with SO1
- N - precedes MIN output with SO1
- X - precedes MAX output with SO1

NOTE

For TRIG LVL, two complete 19 character output bytes are sent in succession. Each Channel requires a complete output sequence.

3-194. MEASUREMENT DATA FIELD. The data field consists of a 14-character string. The number begins with the sign (+ or -), followed by the digits in descending order or significance. The number, however, is right-justified within the data field. To keep the number of characters constant within the total string, spaces (up to 10) will be inserted preceding the sign.

3-195. EXPONENT. Preceded by an "E" and the sign (+ or -), the exponent will be a multiple of 3, similar to the display which is in engineering format. On some occasions, it is possible that the format of the HP-IB output and the display will differ. Nonsignificant zeros in the display are converted to real zeros, and the output is such that there is always a significant digit left of the decimal point.

3-196. The following string illustrates a typical output byte for a FREQ A measurement of 12.3456789 MHz. The output byte is followed by a (CR) carriage return and a (LF) line feed.

F (sp) (sp) +1 2 . 3 4 5 6 7 8 9 0 E + 0 6 (CR) (LF)

NOTE

The Data Output Rate for a complete output string consisting of 19 characters plus a CR and LF is typically 8 ms.

3-197. Output Modes

3-198. The 5335A powers up with the following output modes: WA0, SR0, SO0.

3-199. When the Wait to be Addressed mode is OFF (WA0) the 5335A will output only if it is addressed to talk and RFD is true and measurement data is ready. If at the end of a measurement the 5335A finds that it is NOT addressed to talk or that RFD is false the measurement data is not sent and a new measurement is started.

3-200. When the Wait to be Addressed mode is ON (WA1) the 5335A will wait to be addressed and for RFD to be true. In this mode, new measurements are not started until the data from the previous measurement is sent, or if a command is sent.

3-201. The Wait to be Addressed mode must be active if you want an SRQ generated at the end of the measurement. Status Bit 1 can be used to monitor the 5335A for the end of measurement occurrence. This bit is effective only if the WAIT mode is ON.

3-202. When receiving trigger level data it is recommended that the WAIT mode be ON. This will assure no loss of data. However, the TRIG LVL function is unique in that it does not show a display until *after* it outputs to the display. Therefore, the WAIT mode should be turned OFF if you wish for the display to update.

3-203. Output of Statistics

3-204. For measurements using statistics the individual measurements are not sent out. Only the result of the statistical calculation is output. The prefix alpha character will be the same as the normal measurement.

3-205. The Special Output command "SO" can be sent to tell the 5335A to send additional secondary data when statistics are enabled:

- When STD DEV is on and SO1 has been sent the following data is given in two complete strings:

STD DEV
MEAN (of the same sample, preceded with the letter "M")

- When MEAN is on and SO1 has been sent the following data is given in three complete strings:

MEAN
MIN (of the same sample, preceded with the letter "N")
MAX (of the same sample, preceded with the letter "X")

NOTE

Secondary statistical data will wait for RFD to be true if the listening device is not able to receive the data immediately.

3-206. SPECIAL FUNCTIONS

3-207. Functions 17, 18, 19, and 20 are additional functions that are available in the 5335A.

17 FREQ B
18 TIME B→A
19 TOT A-B
20 PULSE B

These functions are accessed via the HP-IB through the normal FN or FU command, however, they may also be accessed manually through the keyboard. This is an example of invoking FREQ B, function 17:

Press: SCALE SMOOTH 17 ENTER

3-208. After pressing SMOOTH the display will show the word "SPECIAL". After pressing ENTER the counter will be in FREQ B. No function lamp indication is given for these special functions.

- When using TOTALIZE A-B output is given only after the gate is closed. To start the totalizing, a pulse from B must first be received. The TOT A-B (special Function 19) is armed by B. Closing the gate is also synchronized.
- Diagnostics are programmed by sending FN99, followed by a diagnostic code that is programmed into the SCALE register. For example, FN99 MS12, calls up diagnostic 12. (See chapter VIII). Via the keyboard the diagnostics are called similarly. Press SCALE, SMOOTH 99 ENTER, then SCALE 12 ENTER.

3-209. PROGRAMMING EXAMPLES

3-210. The following HP-IB programming examples are provided for information and illustration only. Sample programs are provided for both 9825A and 9835A Computing Controllers, and assume a 5335A address of decimal "3".

EXAMPLE 1. A) TYPICAL MEASUREMENT FORMAT

This program first dimensions a string variable in the controller for the incoming data and then sets the 5335A to its default mode (Initialize) with a gate time of 500 ms (.5 seconds). The counter will then make a simple Frequency A measurement. In step 2 the controller will read the measurement into string A, and then step 3 displays the information. After waiting for 1 second (1000 milliseconds), the program loops back into reading a "new measurement" and the cycle is repeated.

9825A EXAMPLE

```
0: dim A$(211)
1: wrt 703,"in,ga.5"
2: red 703,A$
3: dsp A$
4: wait 1000
5: gto -3
6: end
*24362
```

9835A EXAMPLE

```
10 DIM A$(211)
20 OUTPUT 703;"in,ga.5"
30 ENTER 703;A$
40 DISP A$
50 WAIT 1000
60 GOTO 30
70 END
```

EXAMPLE 1. B) TYPICAL MEASUREMENT FORMAT

This is an example of how the controller can be used to display a measurement once every 5 seconds. After a measurement is accepted in step 2, the HP-IB's RFD (Ready For Data) line is held false until another read instructions is executed. This means that during the wait statement in step 4, the RFD line is false. The 5335A will check the RFD line whenever it is addressed to talk to make sure that the listening device is ready for data. If it finds RFD false and the wait mode is off, the counter will skip trying to output the data and start a new measurement.

In this example the 5335A will continue to make measurements without sending data until 5 seconds have passed. After 5 seconds, the next measurement that comes is sent.

Note that this check of the RFD line is done for the first character of a measurement data string only. Subsequent characters are sent normally.

9825A EXAMPLE

```
0: dim A$(211)
1: wrt 703,"in"
2: red 703,A$
3: dsp A$
4: wait 5000
5: gto -3
6: end
*12686
```

9835A EXAMPLE

```
10 DIM A$(211)
20 OUTPUT 703;"in"
30 ENTER 703;A$
40 DISP A$
50 WAIT 5000
60 GOTO 30
70 END
```

EXAMPLE 2. WAIT MODE

The wa1 command tells the 5335A to wait at the end of each measurement to output data, even if not presently address to talk. During the 5 second wait period in step 4 if a measurement ends the counter will wait until it can send its data before starting the next measurement.

Note that if the gate time of the measurement is very short, the data that gets displayed in this example is about 5 seconds old.

9825A EXAMPLE		9835A EXAMPLE	
0: dim A\$(211)	10	DIM A\$(211)	
1: wrt 703,"in,wa1"	20	OUTPUT 703;"in,wa1"	
2: red 703,A\$	30	ENTER 703;A\$	
3: dsp A\$	40	DISP A\$	
4: wait 5000	50	WAIT 5000	
5: gto -3	60	GOTO 30	
6: end	70	END	
*22874			

EXAMPLE 3. TIME INTERVAL AND PULSE WIDTH

This program will set the 5335A for a Time Interval measurement (fu2), com A (co1) and channel B slope to negative (bs1), in step 0. Step 1 causes the counter to read into the simple variable A and step 2 sets up the controller for a specific floating format. Step 3 displays the contents of the simple variable A; format: "T.I.=____s.". After waiting for 3 seconds in step 4, the controller will set up the 5335A for a Pulse A measurement (fu7) in step 5. In step 6, the 5335A will read into the simple variable B. Step 7 will display the contents of variable B formatted as follows: "PULSE A = ____s.". Following 3 seconds of waiting, the whole process is repeated.

9825A EXAMPLE		9835A EXAMPLE	
0: wrt 703,"in,fu2,co1,bs1"	10	OUTPUT 703;"in,fu2,co1,bs1"	
1: red 703,A	20	ENTER 703;A	
2: flt 5	30	FLOAT 5	
3: dsp "T.I.=";A,"sec."	40	DISP "T.I.=";A;"sec."	
4: wait 3000	50	WAIT 3000	
5: wrt 703,"infu7"	60	OUTPUT 703;"infu7"	
6: red 703,B	70	ENTER 703;B	
7: dsp "PULSE A=";B,"sec."	80	DISP "PULSE A=";B;"sec."	
8: wait 3000	90	WAIT 3000	
9: gto 0	100	GOTO 10	
10: end	110	END	
*6527			

EXAMPLE 4. RISE/FALL TIME AND SLEW RATE

In this example, step 0 sets the 5335A for Rise Time (in, fu10). After a pause of 3 seconds in step 1, (this pause is recommended for allowing the Auto trigger circuitry to settle down). step 2 will force the counter to read into simple variable A. Step 3 sets up the 9825A for a given floating format. In step 4, the 9825A will display: "RISE TIME = ____s.", showing the contents of simple register A. The controller sets up the counter for Positive Slew Rate A (fu11) in step 6, and in step 7, the 5335A reads into simple variable B. In step 8 the controller will display: "POS. SLEW RATE = ____V/S" showing the contents of variable B. The controller sets up the counter for Fall Time (fu10 as1) and waits for 3 seconds in steps 9 and 10. In step 11, the information from the 5335A is read into simple variable A. The controller will display: "FALL TIME = ____s." and the contents of variable A in step 12. The 5335A is set up for a Negative Slew Rate A in step 14, and the controller reads this information into variable B in step 15; then the 9825A will show the contents of B along with the display: "NEG. SLEW RATE = ____V/S" in step 16, after which the whole process is repeated.

9825A EXAMPLE

```

0: wrt 703,"in,fu10"      10
1: wait 3000             20
2: red 703,A             30
3: flt 5                 40
4: dsp "RISE TIME=",A,"sec." 50
5: wait 2000             60
6: wrt 703,"infu11"     70
7: red 703,B             80
8: dsp "POS. SLEW RATE=",B,"V/s" 90
9: wrt 703,"fu10,as1"  100
10: wait 3000           110
11: red 703,A           120
12: dsp "FALL TIME=",A,"sec." 130
13: wait 2000           140
14: wrt 703,"fu11"     150
15: red 703,B           160
16: dsp "NEG. SLEW RATE=",B,"V/s" 170
17: gto 0                180
18: end                  190
*28502

```

9835A EXAMPLE

```

OUTPUT 703;"in,fu10"
WAIT 3000
ENTER 703;A
FLOAT 5
DISP "RISE TIME=";A;"sec."
WAIT 2000
OUTPUT 703;"infu11"
ENTER 703;B
DISP "POS. SLEW RATE=";B;"V/s"
OUTPUT 703;"fu10,as1"
WAIT 3000
ENTER 703;A
DISP "FALL TIME=";A;"sec."
WAIT 2000
OUTPUT 703;"fu11"
ENTER 703;B
DISP "NEG. SLEW RATE=";B;"V/s"
GOTO 10
END

```

EXAMPLE 5. DUTY CYCLE

This program will set up the 5335A for a Duty Cycle measurement (positive portion of waveform, in fu12) in step 0; then, in step 2, forces the counter to read into simple variable A. Step 3 displays the contents of variable A, format: "'UP' Duty Cycle=____%" and maintains the display for 3 seconds (step 4). In step 5, the 5335A is programmed for a Duty Cycle measurement of the negative portion of the wave form (as1) and in step 7, the 9825A will display: "'DOWN' Duty Cycle=____%"; after waiting for 3 seconds, the total cycle is repeated.

9825A EXAMPLE

```
0: wrt 703,"in,fu12"  
1: fxd 4  
2: red 703,A  
3: dsp "'UP' Duty Cycle=",A,"%"  
4: wait 3000  
5: wrt 703,"as1"  
6: red 703,B  
7: dsp "'DOWN' Duty Cycle=",B,"%"  
8: wait 3000  
9: gto 0  
10: end  
*8772
```

9835A EXAMPLE

```
10      OUTPUT 703;"in,fu12"  
20      FIXED 4  
30      ENTER 703;A  
40      DISP "'UP' Duty Cycle=";A,"%"  
50      WAIT 3000  
60      OUTPUT 703;"as1 "  
70      ENTER 703;B  
80      DISP "'DOWN' Duty Cycle=";B,"%"  
90      WAIT 3000  
100     GOTO 10  
110     END
```

EXAMPLE 6. MATH PROGRAMMING EXAMPLE

To demonstrate the 5335A flexibility in mathematical manipulations, apply a signal to INPUT A of different frequencies. Step 2 will request the Offset, Normalize, and Scale factors which are used to program the 5335A in step 3. The manipulated measurement is read into string variable A (step 4). Steps 5 through 10 will print the Offset, Normalize, and Scale factors, respectively; steps 11 and 12 will print the final result.

9825A EXAMPLE

```

0: dim A$(121)
1: fxd 0
2: ent "OFFSET ?",0,"NORMALIZE ?",N,"SCALE ?",S
3: wrt 703,"in,mo",0,"mn",N,"ms",S
4: red 703,A$
5: prt "OFFSET=",0
6: spc
7: prt "NORMALIZE=",N
8: spc
9: prt "SCALE=",S
10: spc 2
11: wrt 16,"RESULT="
12: wrt 16,A$(1,11),A$(15,19)
13: end
*25419

```

9825A PRINTED RESULTS:

```

OFFSET=      100000
NORMALIZE=      50
SCALE=        25

RESULT=
F+50.5014734E+03

```

9835A EXAMPLE

```

10     DIM A$(121)
20     FIXED 0
30     INPUT "OFFSET ?",0
40         INPUT "NORMALIZE ?",N
50         INPUT "SCALE ?",S
60     OUTPUT 703;"in,mo";0;"mn";N;"ms";S
70     ENTER 703;A$
80     PRINT "OFFSET=",0
90     PRINT LIN(1)
100    PRINT "NORMALIZE=",N
110    PRINT LIN(1)
120    PRINT "SCALE=",S
130    PRINT LIN(2)
140    OUTPUT 16;"RESULT="      ";A$(1,11);A$(15,19)
150    END

```

EXAMPLE 7. REMOTE DISPLAY

This program will set up the 5335A for the remote display function, to acquire a measurement, modify and format the measurement into engineering notation, and send the result to the display of the counter.

Step 0 programs the counter for Frequency A and Remote Display (fu1 dr1); the unmodified measurement then is read into simple variable A in step 1. This measurement is modified and stored in variable B (step 2), then sent to the 5335A display in step 3. The cycle is again repeated in step 4.

9825A EXAMPLE

```
0: wrt 703,"fu1dr1"  
1: red 703,A  
2: A+1e6→B  
3: wrt 703,"di",B  
4: gto 1  
5: end  
*27213
```

9835A EXAMPLE

```
10 OUTPUT 703;"fu1dr1"  
20 ENTER 703;A  
30 B=A+1E6  
40 OUTPUT 703;"di";B  
50 GOTO 20  
60 END
```

EXAMPLE 8. TEACH—LEARN

The following program serves as an example of the TEACH—LEARN mode (Binary Program mode). It will allow you to manually set-up the 5335A front panel, after which the 9825A will read into column matrix A, 30 bytes of binary programming data (steps 4 through 7), after which the controller will beep indicating the end of data transfer. (Information recorded: MATH, STATISTICS, FUNCTION, GATE MODE and CYCLE) Then the controller will allow the user to change the front panel settings of the counter (steps 10 and 11). Also, it will allow the user to suppress the MATH information and thereby speeding up the transfer of data (steps 12, 13, and 14). Note however, that the OFFSET, NORMALIZE and SCALE LED will be ON although no information was transferred into their registers. In step 15 the controller will transfer all 30 bytes of binary programming data that it recorded earlier, to the 5335A; at the end of data transfer, the controller will beep twice. The counter is returned to local control in step 19, completing the exercise.

9825A EXAMPLE

```

0: dim A(30)
1: lcl 703
2: dsp "Manually set-up 5335A controls"
3: stp
4: wrt 703,"pq"
5: for I=1 to 30
6: rdb(703)A(I)
7: next I
8: beep
9: lcl 703
10: dsp "Now, change the 5335A controls"
11: stp
12: ent "Do you need MATH functions ?",B
13: if B,gto "LONG"
14: wtb 703,"pb"
15: wtb 703,A(1),A(2),A(3),A(4),A(5),A(6),255
16: beep
17: wait 500
18: beep
19: gto 27
20: "LONG":wtb 703,"pb"
21: for I=1 to 30
22: wtb 703,A(I)
23: next I
24: beep
25: wait 500
26: beep
27: lcl 703
28: end
*28738

```

Press CONTINUE TO RESUME

0 = SHORT DATA TRANSFER
1 = LONG DATA TRANSFER

(Continued)

EXAMPLE 8 (Continued)

9835A EXAMPLE

```

10 DIM A$(30)
20 LOCAL 703
30 DISP "MANUALLY SET-UP 5335A CONTROLS.
      PRESS 'CONT' WHEN READY"
40 PAUSE
50 OUTPUT 703;"pq"
60 ENTER 703 USING "#,30A";A$
61 LOCAL 703
62 BEEP
80 DISP "NOW, CHANGE THE 5335A CONTROLS.
      PRESS 'CONT' WHEN READY"
90 PAUSE
100 INPUT "DO YOU NEED MATH FUNCTIONS ?
      (YES OR NO)",B$

110 IF B$(1,1)="Y" THEN GOTO Long
0 = SHORT DATA { 120 OUTPUT 703 USING "#,2A,6A,B";"pb",A$,255
TRANSFER       { 130 BEEP
1 = LONG DATA { 140 WAIT 500
TRANSFER       { 150 BEEP
              { 160 GOTO 210
170 Long: OUTPUT 703 USING "#,2A,30A";"pb",A$
180 BEEP
190 WAIT 500
200 BEEP
210 LOCAL 703
220 END
  
```

Press CONTINUE
 TO RESUME

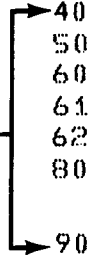

EXAMPLE 9. STATISTICS OUTPUT EXAMPLE

This is an example of the use of Statistic Output format. The controller will request from the user the sample size, either 100 or 1000 (step 1); it will then program the 5335A for a Frequency A measurement with the selected sample size, and special statistics output for MEAN computation (SM1, SO1) in step 2. Step 3 causes the counter to read into the three string variables; the contents of the strings with appropriate leader information will be printed in steps 4 through 10.

The controller will then set up the 5335A for a Standard Deviation measurement and it will store the result in the two string variables (step 11); in steps 12 through 25, the 9825A will print the contents of the variables with appropriate identification.

9825A EXAMPLE

```

0: dim A$(21),B$(21),C$(21)
1: ent "Sample size: 100/1000 (N=0/1) ?",N
2: wrt 703,"insn",N,"sm1,so1"
3: red 703,A$,B$,C$
4: prt "FREQUENCY A"
5: prt "STATISTICS"
6: spc 2
7: prt "MEAN="
8: wrt 16,A$(1,1),A$(15,19)
9: spc
10: prt "MIN="
11: wrt 16,B$(1,1),B$(15,19)
12: spc
13: prt "MAX="
14: wrt 16,C$(1,1),C$(15,19)
15: spc 3
16: beep
17: wrt 703,"sd1"
18: red 703,A$,B$
19: prt "STANDARD DEV. ="
20: wrt 16,A$(1,1),A$(15,19)
21: spc
22: prt "MEAN="
23: wrt 16,B$(1,1),B$(15,19)
24: spc 3
25: beep
26: lcl 703
27: end
*32154

```

(Continued)

EXAMPLE 9 (Continued)

9825A PRINTED RESULTS:

FREQUENCY A
STATISTICS

MEAN= -
F+107.009501E+03

MIN=
N+106.999793E+03

MAX=
X+107.018802E+03

STANDARD DEV. =
F +3.34E+00

MEAN=
M +107.0020E+03

9835A EXAMPLE

```
10 DIM A$(21),B$(21),C$(21)
20 INPUT "Sample size: 100/1000 (N=0/1) ?",N
30 OUTPUT 703;"insn";N;"sm1,so1"
40 ENTER 703;A$,B$,C$
50 PRINT "***** FREQUENCY A STATISTICS *****"
70 PRINT LIN(2)
71 PRINT CHR$(27)&"1" !FREEZES TITLE
80 PRINT " MEAN= ";A$
110 PRINT " MIN= ";B$
140 PRINT " MAX= ";C$
160 PRINT LIN(2)
161 BEEP
170 OUTPUT 703;"sd1"
180 ENTER 703;A$,B$
190 PRINT "STANDARD DEV = ";A$
220 PRINT " MEAN= ";B$
240 PRINT LIN(3)
270 BEEP
280 LOCAL 703
290 END
```

EXAMPLE 10. HIGH SPEED MEASUREMENT (COMPUTER DUMP)

This following program will illustrate how the 5335A can be set-up to perform a high speed transfer of data with the 9825A controller. Line 2 specifies a "fast read-write buffer" labeled "SJ", allocating 2100 bytes of memory. Line 3 initializes the 5335A for a measurement; the buffer is cleared in line 4. In line 5, 100 measurements are transferred directly into buffer "SJ" from the counter; line 6 check for a completed transfer of data, after which, the controller will beep.

The 9835A will, in lines 8 through 10, remove 21 bytes at a time from buffer "SJ" and store them temporarily in A\$, display this information as well as the measurement number; this operation is performed N times.

9825A EXAMPLE

```

0: dim A$(21)
1: 100→N
2: buf "SJ",21*N,3
3: wrt 703,"in,gm2,cy2"
4: buf "SJ"
5: tfr 703,"SJ",N*21
6: if rds("SJ")=-1;jmp 0
7: beep
8: for X=1 to N
9: red "SJ",A$
10: fxd 0
11: dsp A$,X
12: wait 500
13: next X
14: beep
15: end
*5418

```

9835A EXAMPLE

```

10 OPTION BASE 1
20 FIXED 0
30 DIM A$(21),B$(100)(21)
40 N=100
50 OUTPUT 703;"in,gm2,cy2"
60 ENTER 703 BFHS 2100;B$(*)
70 BEEP
80 FOR X=1 TO 100
90 PRINT USING "DDD,XXX,21A";X,B$(X)
91 WAIT 500
100 NEXT X
101 BEEP
110 END

```

EXAMPLE 11. SERVICE REQUEST and WAIT

The following program serves as an example of the SRQ (Service Request) feature in the 5335A. As the controller is executing each program line, it logs in the interrupt request and assigns it a priority; the 9825A will finish the current line and then branch to the service routine (End of Line branching—EOL). Once the service routine is completed (by executing its "iret" statement), the main program pointer will return to the following line from where the interrupt occurred. Line 1 sets up the 5335A into the WAIT mode and enables the sending of SRQ at the end of a measurement; line 2 specifies where to go when the 9825A receives a SRQ, and line 3 enables the use of SRQ. Line 4 simply loops, doing nothing. Lines 5 through 8 are executed whenever an SRQ from the counter is received, a measurement data is then read and the counter is reset.

9825A EXAMPLE

```
0: dim A$(21)
1: wrt 703,"wai,sr1"
2: oni 7,"SRQ"
3: eir 7
4: gto 3
5: "SRQ":
6: if bit(6,rds(703))
7: red 703,A$
8: dsp A$
9: wrt 703,"re"
10: iret
11: end
*2714
```

9835A EXAMPLE

```
10 DIM A$(21)
20 OUTPUT 703;"wai,sr1"
30 ON INT #7 GOSUB Srq !ENABLE END-OF-LINE BRANCHES.
40 CONTROL MASK 7;128 !SET UP INTERRUPT CONDITION.
50 CARD ENABLE 7 !ENABLE CARD FOR INTERRUPTS.
51 WAIT 100
60 GOTO 40
70 Srq: !
80 STATUS 703;Temp
90 IF NOT BIT(Temp,6) THEN 100
100 ENTER 703,A$
110 DISP A$
120 OUTPUT 703;"re"
121 WAIT 100
130 RETURN
140 END
```

EXAMPLE 12. TRIGGER LEVEL

In this example, the controller will set up the counter for trigger Level function (fu14) in step 1; then the 5335A will read into two string variables A\$ and B\$ in step 2 (2 complete 19 character sets are sent out in succession, one for each channel). Steps 3 and 4 will display the contents of the string variables; the whole process is repeated in step 5.

9825A EXAMPLE

```
0: dim A$(21),B$(21)
1: wrt 703,"fu14"
2: red 703,A$,B$
3: dsp "TRIGGER LEVEL A=",A$(11,19);wait 3000
4: dsp "TRIGGER LEVEL B=",B$(11,19);wait 3000
5: gto 1
6: end
*28390
```

9835A EXAMPLE

```
10 DIM A$(21),B$(21)
20 OUTPUT 703;"fu14"
30 ENTER 703;A$,B$
40 PRINT "TRIGGER LEVEL A= ";A$(11,19)
41 PRINT LIN(3)
50 PRINT "TRIGGER LEVEL B= ";B$(11,19)
70 END
```

3-211. OPTIONS

3-212. The operating characteristics of the 5335A are affected by the addition of any of the options described in the following paragraphs.

3-213. Time Base Option 010

3-214. Option 010 provides an Oven-Controlled Crystal Oscillator Time Base, that results in higher accuracy and longer periods between calibration (refer to *Table 1-1*). The oven temperature is maintained when the 5335A LINE switch is in either the ON or the STBY position (provided the instrument is connected to the power mains).

NOTE

The Option 010 Oven-Controlled-Oscillator, HP Model 10811A, is a direct replacement for the previous HP Model 10544A. Service documentation for the *older* 10544A is provided in SECTION VIII under Assembly A12 Oven Oscillator. All service documentation for the newer HP 10811A is provided in the HP 10811A Operating and Service Manual, (HP Part Number 10811-90002) included with Option 010.

3-215. Digital Voltmeter Option 020

3-216. Option 020 provides a fully floating, autoranging digital voltmeter. This module measures dc inputs up to 1000 volts through front panel connectors. Refer to Specifications, *Table 1-1*, for the specific operating characteristics.

3-217. C Channel Option 030

3-218. Option 030 provides a C Channel Input Module, which expands the frequency counting range of the counter to 1.3 GHz. A front panel control adjusts the input sensitivity. A front panel preamp power receptacle is provided. Refer to Specifications, *Table 1-1*, for the specific operating characteristics.

3-219. OPERATOR'S MAINTENANCE

3-220. The only maintenance the operator should normally performs is replacement of the primary power fuse located within the Line Module Assembly. For instructions on how to change the fuse, refer to Section II, Line Voltage Selection.

CAUTION

Make sure that only fuses with the required rated current and of the slow-blow type are used for replacement. The use of repaired fuses and the short-circuiting of fuse-holders must be avoided.

3-221. When Option 030 C Channel is installed, the operator may be required to replace the input BNC fuse. This is a 1/8A fuse (HP Part No. 2110-0301) which is located within the INPUT C BNC connector (see *Figure 3-4* for details). To replace the fuse, disconnect the power cord, unscrew the special BNC barrel (P/N 05305-60205) and, with needle-nose pliers, remove and replace the fuse. Reinstall the BNC barrel, and tighten using a BNC cable connector. Be careful not to overtighten.

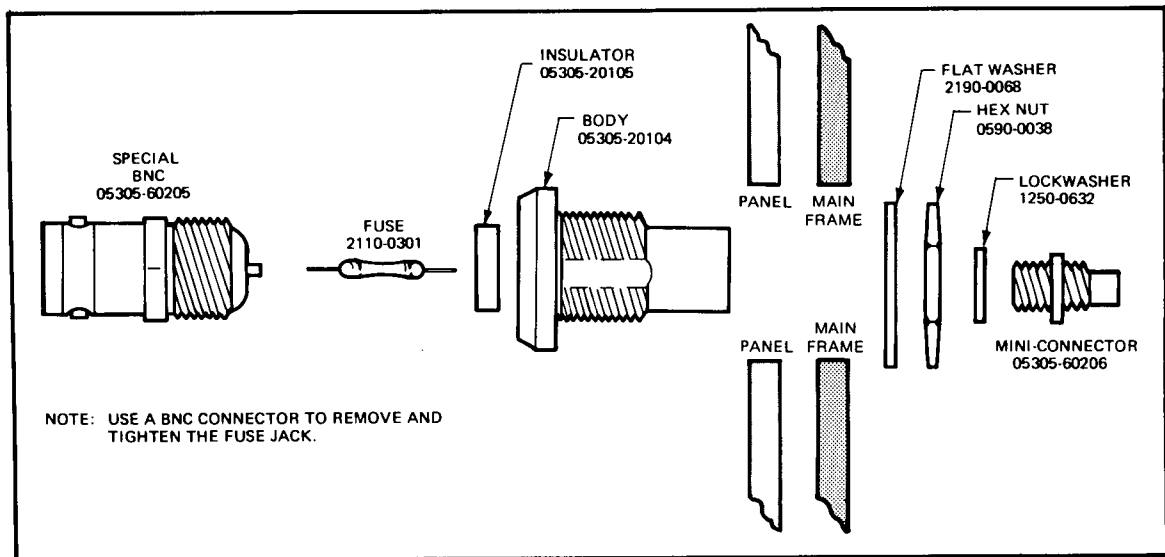

Figure 3-4. Details of Input Connector J1 and Fuse Mounting

3-222. Power/Warm-Up

3-223. The HP Model 5335A requires a power source of 100, 120, 220, or 240V ac, +5%, -10%, 48 to 66 Hz single phase. The selection of line voltage and input power fuse is described in Section II, paragraph 2-5, Preparation for Use.

3-224. The 5335A has a two-position power switch, STBY and ON. For 5335A Option 010 only, it is important that the instrument remain connected to the power source in the STBY mode when not in use. This supplies power to the crystal oven maintaining a constant oven temperature, thus eliminating the need for a warm-up period. When the STBY mode is not used and power is disconnected from the instrument, allow 30 minutes from the application of external power in the ON mode for the instrument (crystal oven) to warm-up.

WARNING

POWER IS ALWAYS PRESENT AT THE LINE SWITCH AND TRANSFORMER, AND UNREGULATED DC IS PRESENT WHENEVER THE LINE CORD IS ATTACHED. UNPLUGGING THE POWER CORD IS NECESSARY TO REMOVE ALL POWER FROM THE INSTRUMENT.

3-225 OPERATOR'S CHECK

3-226. The following procedures will verify the basic operation of the HP5335A Universal Counter. These tests are not intended to verify the overall accuracy or performance specifications of the instrument. They should, however, provide the operator a quick method of determining that the counter is operating properly. The tests are provided in two levels; a DISPLAY CHECK and a FRONT PANEL CHECK. The operator should perform both tests.

A. DISPLAY CHECK

To perform the HP5335A DISPLAY CHECK, momentarily press the key labeled "CHECK". Verify that all display annunciators, except "STBY" and the A and B Channel Trigger lights, cycle ON and OFF. Pressing any Function key will return normal operation.

B. FRONT PANEL CHECK

To perform the HP5335A FRONT PANEL CHECK, use a BNC cable to connect the rear panel TBO (Time Base Output) to the front panel INPUT A. Set the HP5335A controls as follows:

1M/50 Ω 50 Ω

3-227. Press and hold the "CHECK" button for about three seconds. Verify that all HP5335A display annunciators turn ON for approximately ten seconds; during which the front end amplifiers are checked for the accuracy, cross-talk, attenuation and separate/common with the input signal. Successful completion of the test loop is indicated by a display of "FE PASS". Any failures are identified by a numbered fail message. For a description of the numbered FAIL messages, refer to paragraph 3-229.

3-228. The FRONT PANEL CHECK is a built-in continuous loop, which will repeat until manually reset. To halt the test and return to normal operation, press any Function key.

3-229. ERROR/FAIL MESSAGES

3-230. Under certain conditions the 5335A will display either Error or Fail type messages. These messages typically occur during the power-up cycle. The fail messages are displayed in a continuous loop, and generally indicate a hardware related problem. Error messages indicate that the user has attempted an improper operation, either through the keyboard or the HP-IB. *Table 3-9* lists the Error Messages, and *Table 3-10* lists the Fail Messages. If a Fail message is displayed, refer to the troubleshooting information in Section VIII.

Table 3-9. Error Messages

1.0	HP-IB Error:	Incorrect command
1.1	HP-IB Error:	Number out of range or incorrect number within command
7.0	Check Error:	Cable may not be connected between T.B.O. and INPUT A for extended CHECK, Diag 01 or Diag 14.

Table 3-10. Fail Messages

FAIL	1.0 - 1.4	ROM FAILURE (U22)
	1.5 - 1.8	ROM FAILURE (U23)
	1.9	ROM FAILURE (SPECIALS)
	2.0	RAM FAILURE (6802)
	2.1	RAM FAILURE (U25)
	2.2	RAM FAILURE (U26)
	3.1	OUT-BUS PROBLEM (BIT 5 OR 7)
	3.2	OUT-BUS PROBLEM (BITS 0-7, OR U8,
	3.3	U9, U13, U14, U6, OR U7)
	3.4	START ARM SWITCH PROBLEM
	3.5	STOP ARM SWITCH PROBLEM
	4.1	MRC STATUS REGISTER WON'T RESET (U6-U7)
	4.2	MRC E-REG WON'T RESET
	4.3	MRC T-REG WON'T RESET
	4.4	IMPROPER MID-MEAS REGISTER STATUS
	4.5	IMPROPER END-OF-MEAS REGISTER STATUS
	4.6	MRC COUNTING PROBLEM IN REG-E OR T
	4.7	MRC E-REG OVERFLOW PROBLEM
	4.8	MRC T-REG OVERFLOW PROBLEM
	4.9	MRC O/F COUNTING PROB IN REG-E OR T
	5.1	START INTERPOLATOR PROBLEM
	5.2	STOP INTERPOLATOR PROBLEM
	5.3	INTERPOLATOR COUNTING PROBLEM
	5.4	INTERPOLATOR RESET PROBLEM
	6.1	FAILURE TO MEASURE T/L REFERENCE GND.
	6.2	FAILURE TO MEASURE T/L REFERENCE +5V.
	6.3	FAILURE TO MEASURE T/L REFERENCE -5V.
	7.1	CH-A FREQUENCY NOT CORRECT
	7.2	COM/SEP RELAY COUPLING SIGNAL TO CH-B
	7.3	CH-B UNABLE TO TRIG THRU COMMON-A.
	7.4	CH-B FREQUENCY NOT CORRECT
	7.5	CH-A PRESCALER NOT FUNCTIONING PROPERLY

5335A OPERATING INSTRUCTIONS

FUNCTION SELECTION

- KEY PER FUNCTION. SETTINGS FOR MATH, STATISTICS, RANGE HOLD, EXT ARM ENABLE, GATE/DELAY AND CYCLE ARE REMEMBERED FROM PREVIOUS FUNCTION. RETURNING TO PREVIOUS FUNCTION RETURNS THESE SETTINGS.

GATE MODES

- NORM: 20 MS-4 SEC. FAST: 100 MS-20 MS. SET VIA GATE ADJUST CONTROL.
- MIN: SHORTEST POSSIBLE GATE TIME.
- MANUAL: EACH PRESS WILL OPEN OR CLOSE THE GATE. GATE STATUS IS INDICATED BY GATE LAMP.

T.I. DELAY

- FOR MEASUREMENTS WITH T.I. DELAY, SET THE GATE MODE TO NORM, FAST, OR MANUAL. THE T.I. LAMP WILL BE ON. SETTING DELAY IS THE SAME AS FOR GATE TIME.
- FOR TIME A-B, 1/TIME A-B, AND PULSE A, SET THE GATE MODE TO MIN (NO DEL) IF T.I. DELAY IS NOT TO BE USED.

CYCLE MODES

- NORM: ~ 4 READINGS/SECOND OR LESS.
- MIN: FAST AS POSSIBLE, UP TO ~ 15 READINGS/SECOND.
- SINGLE: EACH PRESS STARTS ONE MEASUREMENT.

TRIGGER LEVELS

- AUTO TRIG OFF
 - PRESET: TRIGGER POINT IS OV.
 - ADJUSTMENT RANGE IS -5V TO +5V.
- AUTO TRIG ON (30 Hz MINIMUM FREQUENCY)
 - PRESET: TRIGGER POINT SET TO 50% LEVEL OF INPUT SIGNAL.
 - ADJUSTMENT RANGE IS BETWEEN NEGATIVE AND POSITIVE PEAKS OF INPUT SIGNAL.

GENERAL

- MATCHED 200 MHz AMPLIFIERS. 25 MV RMS SENSITIVITY. 5V PP MAX. 2 PARTS IN 10⁶/SECOND OR 2MS BASIC RESOLUTION.
- RESET STARTS A NEW MEASUREMENT. IN TOTALIZE THE COUNT IS RESET TO ZERO. RETURNS TO LOCAL IF IN REMOTE, LLO OFF.
- RANGE HOLD FREEZES EXPONENT UNLESS OVERFLOW OCCURS.
- EXT. ARM ENABLE. WHEN ON, ALLOWS REAR PANEL ARMING OF START AND/OR STOP OF MEASUREMENT. SLOPES ARE DETERMINED BY REAR PANEL SWITCHES. EXT. GATE, SAME AS EXT ARM WITH BOTH START AND STOP ARM ACTIVE, AND GATE MODE IN MIN.
- CHECK DOES INTERNAL SELF TEST. PRESS ANY OTHER KEY TO EXIT. SEE MANUAL IF ERROR 7.0 RESULTS.

MATH

- ALL MEASUREMENTS, EXCEPT GATE TIME AND TRG LVL, MAY BE MODIFIED BY OFFSETTING, NORMALIZING AND SCALING.

$$\text{DISPLAY} = \frac{\text{MEASUREMENT} + \text{OFFSET}}{\text{NORMALZ}} \times \text{SCALE}$$

- NUMBER ENTRY: ENTER VALUES INTO THE OFFSET, NORMALZ, OR SCALE REGISTERS BY USING THE SHIFTED BLUE LABELED KEYS. PRESSING ANY OF THE THREE BLUE KEYS STARTS THE NUMBER ENTRY. THAT KEY'S LAMP WILL FLASH, AND THE DISPLAY WILL SHOW THE CURRENT VALUE IN THAT REGISTER. ENTER A NUMBER, IF NEEDED. 'CHS': CHANGES SIGN OF THE MANTISSA OR EXPONENT. 'EXP': STARTS EXPONENT ENTRY. SETTING OFFSET TO 'LAST DISP' SUBTRACTS THE LAST DISPLAYED VALUE FROM ALL FUTURE MEASUREMENTS. SETTING OFFSET TO 'MEAS L-1' SUBTRACTS FROM EACH NEW MEASUREMENT THE VALUE OF THE PREVIOUS MEASUREMENT. 'MEAS L-1' IS INDICATED BY "L-1". COMPLETE ENTRY BY PRESSING "ENTER". IF THE PARTICULAR MATH FUNCTION IS TO BE TURNED OFF PRESS "DISABLE". INSTEAD A MATH FUNCTION IS ON IF ITS ASSOCIATED LAMP IS ON. DURING NORMAL OPERATION ALL ACTIVE MATH FUNCTIONS MAY BE TOGGLED ON OR OFF BY PRESSING "DISABLE".

STATISTICS

- STD. DEV. IS A SAMPLE STANDARD DEVIATION. SEE MANUAL FOR HP-IB OUTPUT.
- MEAN IS THE AVERAGE OF THE SAMPLE.
- SAMPLE SIZE TOGGLES BETWEEN 100 AND 1,000 WITH EACH PRESS OF THE N=100/1K KEY.
- SMOOTH PERFORMS A RUNNING AVERAGE AND TRUNCATES UNSTABLE DIGITS.

HP-IB

- WHEN ADDRESSED TO TALK, MEASUREMENT DATA IS SENT IN THIS FORMAT: (ALPHA) (14 CHAR DIGIT FIELD) E ± (2 DIGITS) CR/LF
- USE UNDERLINED CHARACTERS ON FRONT PANEL FOR THE TWO LETTER COMMAND NAMES. USE COMMA, SEMICOLON, SPACE, CARRIAGE RETURN/LINE FEED FOR OPTIONAL DELIMITERS. LAST CHARACTER IN A COMMAND STRING MUST BE A DELIMITER.
- STATUS: BIT 1 (LSB) - MEASUREMENT DONE. BIT 2 - EXT. OSC. USED. BIT 3 - ERROR BIT 4 - FAIL. BIT 6 - GATE. ERROR 1.0 - BAD COMMAND. ERROR 1.1 - BAD NUMBER. FAIL - SEE MANUAL.
- OTHER COMMANDS - DR, DI, IN, PO, PR, SR, WA, GC, CC, ID.

Figure 3-5. 5335A Operating Instructions Label

SECTION IV OPERATIONAL VERIFICATION

4-1. INTRODUCTION

4-2. The procedures in this section provide a quick method of verifying the basic operation of the HP 5335A Universal Counter. They can be performed without access to the interior of the instrument.

4-3. LOCAL OPERATIONAL VERIFICATION

4-4. The abbreviated checks given in *Table 4-1* can give the operator a high degree of confidence that the 5335A is operating properly, without performing a complete performance test. The operational verification is useful for incoming QA, routine maintenance, and after instrument repair. The Options 020, and 030 Operational Verification are included in *Table 4-1*. The HP-IB Verification Program is given in paragraphs 4-11 through 4-18.

4-5. EQUIPMENT REQUIRED

4-6. Equipment required for the complete test and operational verification is listed in *Table 1-4*. Any equipment which satisfies the critical specifications given in the table may be substituted for the recommended model numbers.

4-7. TEST RECORD

4-8. Results of the operational verification may be tabulated on the Operational Verification Test Card, at the end of Section IV.

4-9. ERROR/FAIL MESSAGES

4-10. Under certain conditions the 5335A will display either Error or Fail messages. These messages typically occur during the power-up cycle. The fail messages are displayed in a continuous loop, and generally indicate a hardware related problem. Error messages indicate that the user has attempted an improper operation, either through the keyboard or the HP-IB. *Table 4-2* lists the Error Messages, and *Table 4-3* lists the Fail Messages. If a Fail message is displayed, refer to the troubleshooting information in Section VIII.

Table 4-1. Local Operational Verification

- I. The tests in the following procedure were designed to be performed sequentially. The last step in each test will leave the 5335A prepared for the next test in the sequence.

CAUTION

Before switching on the instrument, ensure the following:

- 1) the transformer primary is matched to the available line voltage,
- 2) the correct fuse is installed,
- 3) all safety precautions have been observed.

For details see Power Requirements, Line Voltage Selection, Power Cables, and associated warnings and cautions in Section II of this manual.

- II. PRESET: 5335A Power Switch to STBY (OUT)
NOTE: If the 5335A line voltage selector is set to 120V the line voltage is nominally 115V.

CONNECT: 5335A Power Cable to Line Voltage

VERIFY: Red Standby Lamp is ON

- III. PRESET: 5335A Rear HP-IB ADDR Switches to 0 (DOWN)

- IV. PRESET: 5335A Front Panel as follows:
- | | |
|------------------------|----------------|
| CHANNEL A & B PRESET | ON (fully CCW) |
| CHANNEL A & B 1M/50ohm | 50ohm (IN) |
| AUTO TRIG | ON (IN) |
| CHANNEL A & B X10 ATTN | X1 (OUT) |
| CHANNEL A & B AC/DC | DC (OUT) |
| CHANNEL A & B SLOPES | POS. (OUT) |
| GATE ADJ | fully CCW |
| COM A | ON (IN) |

- V. POWER-UP/SELF-CHECK

NOTE

When the counter is turned on, an internal check is made of several major components in the counter's circuitry. After the power-up sequence, the counter will initialize itself. All Math and Statistics will be OFF, the function will be **FREQ. A**, and the Gate and Cycle Modes will be in **NORM**. All of the input controls will be set according to their switch positions.

Any failures during the power-up cycle will disable the counter and produce a display of numbered **ERROR** or **FAIL** messages. For a description refer to **ERROR MESSAGES**, paragraph 4-9.

SET: 5335A Power Switch to ON (IN)

- VERIFY:
- 1) Red Standby Lamp is OFF.
 - 2) All display and annunciator lamps turn on momentarily (excluding standby and trigger lamps).
 - 3) Display shows "HP-IB Addr 00" for about 1 sec.
 - 4) Display shows "0"; Hz lamp is ON.
 - 5) FREQ A lamp is ON.
 - 6) All other lamps are off (except trigger which may be on).
 - 7) Fan is ON.
 - 8) NO FAIL or ERROR messages displayed.

Table 4-1. Local Operational Verification (Continued)

VI. SUPER CHECK

NOTE

The SUPER CHECK is a continuous diagnostic loop which will repeat until manually reset; during this cycle the Front End amplifiers are checked for accuracy, cross talk, attenuation and separate/common with the input signal. In addition the 5335A checks the operation of the following:

ROMS
RAMS
DATA BUS
FRONT PANEL DISPLAY
MRC
INTERPOLATORS
TRIGGER LEVEL REFERENCES (GND, +5V, -5V)
CHANNEL A & B TRIGGERING
SEP/COM RELAY
PRESCALER
POWER SUPPLY VOLTAGES (+5V, +3V, -5.2V)

Any failures are identified by a numbered ERROR or FAIL message. For a description refer to ERROR/FAIL MESSAGES, paragraph 4-9. If a FAIL message is displayed, refer to the troubleshooting information in Section VIII.

A) CONNECT: A 4-foot BNC cable (HP P/N 10503A) from the 5335A rear panel TIME BASE OUT to the front panel INPUT A jack. Ensure both inputs are set to 50Ω.

B) PRESS: 5335A keys

- 1) SCALE
- 2) SMOOTH (Display will show "SPECIAL +0")
- 3) 9
- 4) 9
- 5) ENTER (Display will show "DIAG 01")

VERIFY: 1) All display annunciator lamps turn ON for about 5 sec.
2) Successful completion of the SUPER CHECK test loop displays the message "FE PASS" for about 15 sec.
3) Display shows **nominal** values of 3 Supply Voltages:

5. 000 00 V
3. 100 00 V
-5. 200 00 V

NOTE

If TIME BASE OUT is not connected to INPUT A, ERROR 7.0 will be displayed.

Table 4-1. Local Operational Verification (Continued)

VII. FRONT END SWITCH TEST

A) SET: 5335A front end switches as follows:
 CHANNEL A & B SLOPES NEGATIVE (IN)
 CHANNEL A & B PRESETS OFF
 CHANNEL A & B ATTN X10 (IN)
 COM A ON (IN)
 AUTO TRIG ON (IN)

B) PRESS: 5335A KEYS:
 1) SCALE, SMOOTH, 99, ENTER
 2) SCALE, 5, ENTER

NOTE

Step (1) is not necessary when done in sequence.

OBSERVE: 5335A display shows "8.8.8.8.8.8.8.8."

VERIFY AND RECORD ON TEST CARD.

C) SET: 5335A front end switches as follows:
 CHANNEL A & B SLOPES POSITIVE (OUT)
 CHANNEL A & B PRESETS ON
 CHANNEL A & B ATTN X1 (OUT)
 COM A OFF (OUT)
 AUTO TRIG OFF (OUT)

OBSERVE: 5335A display is BLANK (no "8" showing)

VERIFY AND RECORD ON TEST CARD.

D) PRESS: The following 5335A KEYS:
 CHANNEL A & B SLOPES
 CHANNEL A & B PRESETS
 CHANNEL A & B ATTN
 COM A
 AUTO TRIG

OBSERVE: When the respective KEY is pressed IN the display shows a figure "8" at the corresponding digit and the display goes blank when the respective KEY is OUT, as shown below in Figure 4-1.

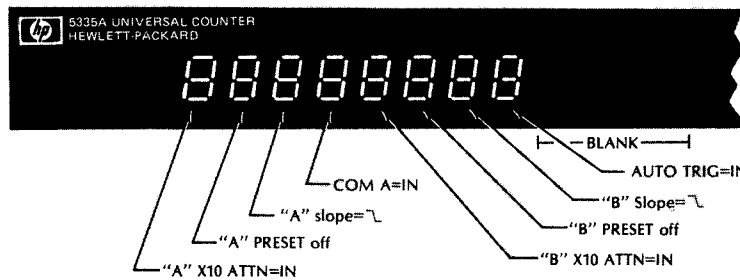

Figure 4-1. Front End Switch Test Display

VERIFY AND RECORD ON TEST CARD.

Table 4-1. Local Operational Verification (Continued)

VIII. REAR PANEL EXTERNAL ARMSLOPE SWITCH TEST

A) CONNECT: 5335A rear panel TIME BASE OUT to TIME BASE IN with BNC Cable.

B) SET: 5335A rear panel EXTERNAL ARM START & STOP slope switches
BOTH to Positive (UP)

C) PRESS: The following 5335A KEYS:
1) SCALE, SMOOTH, 99, ENTER
2) SCALE, 6, ENTER

NOTE

Step (1) is not necessary when done in sequence.

OBSERVE: 5335A display shows " 8.8.8. "
(only the 4th, 6th and 8th digit ON)

VERIFY AND RECORD ON TEST CARD.

D) SET: 5335A rear panel EXTERNAL ARM START & STOP slope switches
BOTH to Negative (DOWN)

OBSERVE: 5335A display shows " 8.8.8. "
(only the 4th, 5th and 7th digit ON)

VERIFY AND RECORD ON TEST CARD.

E) REMOVE: Signal from TIMEBASE OUT to TIMEBASE IN.

OBSERVE: 5335A display, 4th digit goes blank.

NOTE

TIME BASE OUT should NOT be connected to TIME BASE IN during normal operation.

F) SET: 5335A rear panel EXTERNAL ARM START & STOP slope switches
BOTH to OFF (MIDDLE)

OBSERVE: 5335A display is BLANK

VERIFY AND RECORD ON TEST CARD.

NOTE

If any 5335A front panel MATH, STATISTICS, FUNCTION, GATE MODE, or CYCLE KEY is pressed while in DIAG 06, the segments and decimal point of the 3rd digit in the display will cycle.

Refer to Figure 4-2. Rear Arm Switch Test Display on page 4-6.

Table 4-1. Local Operational Verification (Continued)

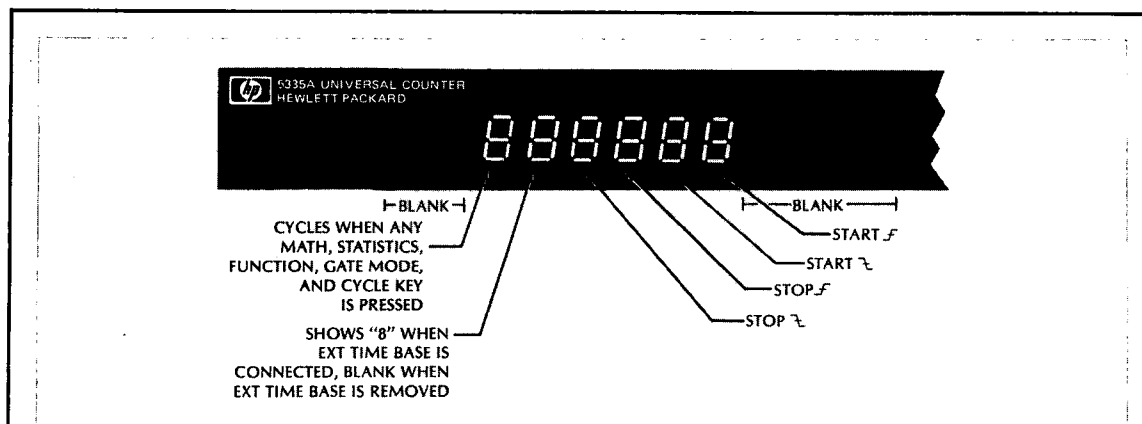

Figure 4-2. Rear Arm Switch Test Display

While in DIAG 06 the rear panel EXTERNAL ARM START & STOP Switch positions correspond to the Display Digits as shown above in Figure 4-2, and the 3rd and 4th display digits will respond as indicated.

NOTE

You must cycle POWER SWITCH to STBY and back to ON to exit DIAG 06.

IX. KEYBOARD CHECK

- A) PRESS: 5335A KEYS:
- 1) SCALE, SMOOTH, 99, ENTER
 - 2) SCALE, 17, ENTER (Display shows "DIAG 17")
- B) PRESS: Each key on the 5335A front panel. Begin with the upper left key (MATH DISABLE) and go down each column until the lower right key is pressed.
- OBSERVE: As each key is pressed:
- 1) The "+0" EXPONENT will light and a 2 digit display will actively correspond to the chart below in Figure 4-3.
 - 2) The key's lamp will turn ON (except for RESET, CHECK & CYCLE NORM, which have no lamp).

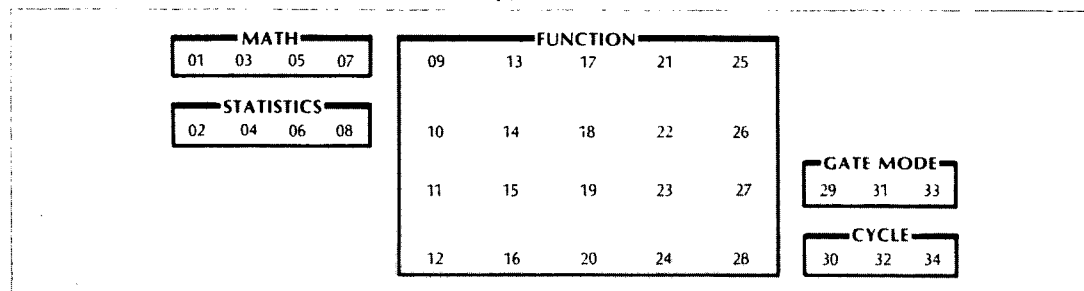

Figure 4-3. Keyboard Check Key Assignments

VERIFY AND RECORD ON TEST CARD.

NOTE

You must cycle Power Switch to STBY and back to ON to exit the KEYBOARD CHECK.

Table 4-1. Local Operational Verification (Continued)

X. DVM TEST (option 020)

A) CONNECT: A 4-foot BNC cable from the 5335A rear panel Trigger Level "A" or "B" to the DVM input jack.

B) SET: CHANNEL A & B OFF

C) PRESS: 5335A Key VOLTS

OBSERVE: Display shows approx. "-5.2XX" V

D) INVERT: The DVM input terminal connector.

OBSERVE: Display shows approx. "+5.2XX" V

VERIFY AND RECORD ON TEST CARD.

XI. CHANNEL "C" TEST (option 030)

A) CONNECT: The following:

- 1) the HP 86603A to the 5335A Channel C INPUT,
- 2) the HP 8660C Time Base Out to the 5335A Time Base IN.

B) PRESS: 5335A Key FREQ C

C) VARY: The frequency of the HP 8660C.

OBSERVE: The 5335A display shows the output frequencies of the HP 8660C within the C Channel published Specs.

VERIFY AND RECORD ON TEST CARD.

Table 4-2. Error Messages

1.0	HP-IB Error:	Incorrect command
1.1	HP-IB Error:	Number out of range or incorrect number within command
7.0	Check Error:	Cable may not be connected between T.B.O. and INPUT A for extended CHECK, Diag 01 or Diag 14.

Table 4-3. Fail Messages

FAIL	1.0 - 1.4	ROM FAILURE (U22)
	1.5 - 1.8	ROM FAILURE (U23)
	1.9	ROM FAILURE (SPECIALS)
	2.0	RAM FAILURE (6802)
	2.1	RAM FAILURE (U25)
	2.2	RAM FAILURE (U26)
	3.1	OUT-BUS PROBLEM (BIT 5 OR 7)
	3.2	OUT-BUS PROBLEM (BITS 0-7, OR U8,
	3.3	U9, U13, U14, U6, OR U7)
	3.4	START ARM SWITCH PROBLEM
	3.5	STOP ARM SWITCH PROBLEM
	4.1	MRC STATUS REGISTER WON'T RESET (U6-U7)
	4.2	MRC E-REG WON'T RESET
	4.3	MRC T-REG WON'T RESET
	4.4	IMPROPER MID-MEAS REGISTER STATUS
	4.5	IMPROPER END-OF-MEAS REGISTER STATUS
	4.6	MRC COUNTING PROBLEM IN REG-E OR T
	4.7	MRC E-REG OVERFLOW PROBLEM
	4.8	MRC T-REG OVERFLOW PROBLEM
	4.9	MRC O/F COUNTING PROB IN REG-E OR T
	5.1	START INTERPOLATOR PROBLEM
	5.2	STOP INTERPOLATOR PROBLEM
	5.3	INTERPOLATOR COUNTING PROBLEM
	5.4	INTERPOLATOR RESET PROBLEM
	6.1	FAILURE TO MEASURE T/L REFERENCE GND.
	6.2	FAILURE TO MEASURE T/L REFERENCE +5V.
	6.3	FAILURE TO MEASURE T/L REFERENCE -5V.
	7.1	CH-A FREQUENCY NOT CORRECT
	7.2	COM/SEP RELAY COUPLING SIGNAL TO CH-B
	7.3	CH-B UNABLE TO TRIG THRU COMMON-A.
	7.4	CH-B FREQUENCY NOT CORRECT
	7.5	CH-A PRESCALER NOT FUNCTIONING PROPERLY

4-11. HP-IB VERIFICATION PROGRAM USING THE 9825A CONTROLLER

4-12. The 9825A program listed in *Table 4-6* exercises the 5335A through various operating modes via the HP-IB interface. It is also designed to test Option 020 (DVM), and Option 030 (Channel C). If the 5335A successfully completes all phases of the verification program, then there is a high probability that the HP-IB Interface (A7 and A14 assemblies), and the counter are working properly.

4-13. To perform the verification, set up the 5335A as shown in *Figure 4-4*, and set the 5335A rear panel address switches to address 03.

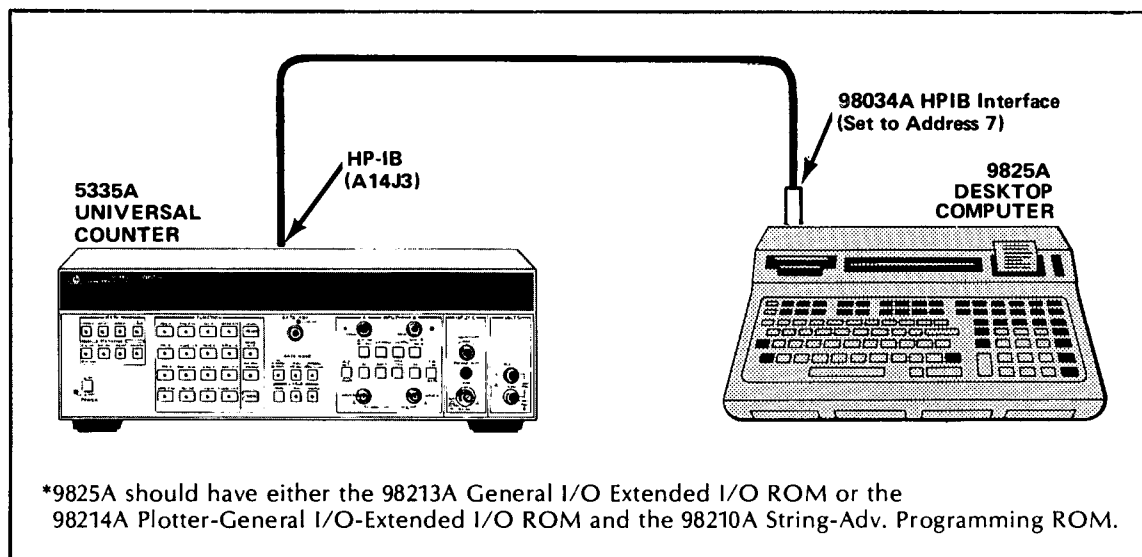

Figure 4-4. HP-IB Verification Set-Up

4-14. The program listed in *Table 4-6* may be keyed into the 9825A or loaded from an HP-IB Verification Cassette, HP P/N 59300-10001 (revision J or later), which also contains HP-IB verification programs for the 59300 series of instruments. To run the program on the cassette, insert the cassette into the 9825A, load file 0 (type ldp0), and press EXECUTE. Enter "5335" when the instrument model number is requested, and press CONTINUE. Enter select code "703" when the select code is requested, and press CONTINUE. The 9825A will then load the 5335A verification program into memory.

NOTE

A select code other than 703 may be used. Remember to set the 5335A rear panel ADDRESS switch to correspond to the chosen select code. The address is the last two digits in decimal. Therefore, if select code is 703, the counter must be set to 03. The "7" refers to the I/O port select code of the controller. Do not use select code 721 (calculator address).

4-15. Set up the 5335A front panel switches as described in the printout, and press CONTINUE. Follow the directions described on the printout to proceed with the HP-IB verification.

4-16. The program goes through 15 check points for the standard instrument, and an additional 2 check points for options 020, and 030. The information in *Table 4-5* shows what occurs during each test and what should be observed by the operator if the test has been successfully completed. At the conclusion of each test, the program stops and displays the current check point. To advance to the next test, simply press CONTINUE. If it is desired to repeat a test, key in cont and the check point number, and press EXECUTE, (e.g. to repeat test 3, key in cont "3"). To go on to the next test after looping, press CONTINUE.

4-17. At the end of the HP-IB Verification Program, the controller will ask if you want to repeat one of the tests. Answer "1" for YES and "0" for NO, then push CONTINUE. If YES, the controller then asks which test is to be repeated. Enter the appropriate number for the test needed (as indicated on the printout), then press CONTINUE. The selected test will then be repeated. At the end of that particular test the question whether or not to repeat a test is asked again. If you want to repeat the same test press CONTINUE three times. If not, press CONTINUE, enter 0 and press CONTINUE, again.

NOTE

If the last test performed was TEST #14, Front Panel Switch Test, you will need to turn the 5335A power OFF then ON in order to return the counter to local control.

4-18. If it is desired to test a specific check point within the HP-IB Verification Program, load the tape or key in the program in the normal manner. Proceed until the controller prints the set-up information. Then key in cont "rpt". . . and press EXECUTE. The program will advance to the end and the controller will ask if you want to repeat one of the tests. Then use the method described in paragraph 4-17.

NOTE

Table 4-4 is provided as a quick reference for the HP-IB verification procedure.

Table 4-4. HP-IB Verification

To perform the HP-IB verification proceed as follows:

1. Set up the 5335A and the 9825A as shown in Figure 4-4.
2. Set the 5335A rear panel ADDRESS switch (A1451) as follows:

3. Key the program listed in Table 4-5 into the 9825A, or insert cassette, HP P/N 59300-10001 (revision J or later).
4. Load and run file 0. (Key in ldp0); press .
5. Key in the model number of the instrument to be tested (i.e. 5335); press .
6. Key in select code 703; press .
7. Set up the 5335A as described in the printout and press .
8. Always press to advance the program.

Table 4-5. 9825A Program Printout

5335A UNIVERSAL
COUNTER HP-IB
Verification
Program.

SETUP:
both chans
50 chans:XI,DC;
all slopes=pos;
levels = preset;
sep/com A=com A;
Auto Trig. ON;
Gate Adj.=
full ccw.

CONNECT:
Time Base Out
from rear panel
to INPUT A.

Press CONTINUE.

Turn 5335A power
OFF then ON.

} Set-up instructions for the 5335A front panel.

Table 4-5. 9825A Program Printout (Continued)

```
-----  
CHECK POINT 1  
5335A front  
panel set-up  
check. Verify:  
*RED LED 'STBY'  
lamp is OFF  
*All display  
annunciator  
lamps turn ON  
momentarily  
(excluding  
'STBY' and  
trigger lamps)  
*Display shows  
the selected  
HP-1B address  
for about 1 sec  
*Display then  
shows '0.'  
momentarily;  
Function FREQ A  
and Hz annun.  
lamps are ON  
*Then 5335A will  
display:  
10. 000 000 +6  
with 'Hz' LED  
ON; 'GATE', 'A'  
and 'B' Trigger  
lites flashins.
```

} Checks the 5335A power-up conditions and performs basic Frequency A measurement.

```
-----  
CHECK POINT 2  
Program sends  
5335A 'listen'  
address.
```

```
Verify:  
Display is same  
as above except  
'LISTEN' and  
'REMOTE'  
annunciators  
are lit.
```

} Set the 5335A in the "REMOTE" and "LISTEN" state.

Table 4-5. 9825A Program Printout (Continued)

CHECK POINT 3
Program sends
5335A talk
address. Verify:
Display is same
as CHECK POINT 1
except 'TALK'
and 'REMOTE'
ennunciators
are lit.

} Addresses the 5335A to make a FREQ A measure-
ment and to output the data.

OUTPUT test:
Verify:
Same readings on
calculator
display
as on 5335A
display.
(Available for
10 seconds.)

CHECK POINT 4
Press LOC/RESET
on 5335A.
Verify: 'REMOTE'
LED goes out.

} Operator verification of proper operation of the front
panel LOC/REM function. (No remote codes sent.)

CHECK POINT 5
Program sets
5335A in the
'local-lockout'
mode.
Press LOC/RESET
on the 5335A and
verify that
'REMOTE' LED
stays ON.

} Programs the 5335A to go-to-remote and activates
counters local-lockout (LLO).

Table 4-5. 9825A Program Printout (Continued)

CHECK POINT 6
Program sets
5335A in the
WAIT and
SERVICE REQUEST
mode.

Verify that the
following LEDs
are lit during
five (5)
measurements:
* TALK
* LISTEN
* SRQ
* REMOTE

The 5335A is programmed to wait until it is addressed to talk before making another measurement. At the end of the measurements the program will "beep".

CHECK POINT 7
TEACH-LEARN Test

Verify that the
5335A displays
11. 224 49 +15
Hz.

5335A will teach
the 9825A the
front panel
setup.

The 5335A is first programmed for a particular setting, then the counter will teach the 9825A the front panel setup. When CONTINUE is pressed, the 5335 is set up for a Period A measurement.

Verify that the
5335A displays
100. 000 00 -9
with 'S' and
Function PER A
lites ON, and
'GATE' LED fla-
shing.

5335A will learn
from 9825A.
Verify that the
5335A displays
11. 224 49 +15
Hz.

When CONTINUE is pressed again, the 5335A will learn from the 9825A.

Table 4-5. 9825A Program Printout (Continued)

CHECK POINT 8
FREQ B Test.

SETUP:
Connect TBO from
rear panel to
INPUT B.

VERIFY:
*5335A displays
10.000 000 +6
*'Hz' lamp ON
*'GATE' lamp
flashing
*'LISTEN' and
'REMOTE' lamps
are lit
*ALL FUNCTION
lamps OFF
*'B' trigger
light flashing.

} The 5335A is set up and programmed for a Frequency B measurement.

CHECK POINT 9
TRIG LEVEL Test.

Program sets
Trig Lvl funct.

VERIFY:
Trigger Level A=
+0.00V (actual)

Trigger Level B=
+0.00V (actual)

} The 5335A is set up to measure and display Channel A and B trigger levels.

Table 4-5. 9825A Program Printout (Continued)

CHECK POINT 10
GATE TIME Test.

GATE ADJ. Normal
Range test.
Vary 'GATE ADJ.'
pot and verify
change in Gate
Time displayed;
NOMINALLY,
between 20
milliseconds
and 4 seconds.

GATE ADJ. Fast
Range test.
Vary 'GATE ADJ.'
pot and verify
change in Gate
Time displayed;
NOMINALLY,
between 100
microseconds
and 20 milli-
seconds.

Both gate time ranges of the 5335A are programmed.

Table 4-5. 9825A Program Printout (Continued)

CHECK POINT 11
RISE/FALL TIME
Test.

SETUP:
Connect TBO from
rear panel to
INPUT A.

RISE TIME test.

VERIFY:
*RISE/FALL A
lamp is ON
*5335A displays
approximately
30 nanoseconds
*Gate Mode MIN
lamp is ON
*'GATE' lamp
flashing
*'A' and 'B'
trigger lamps
flashing
*'LISTEN'
lamp ON
*'REMOTE'
lamp ON.

FALL TIME test.
Verify: 5335A
display is about
the same as for
Rise Time test.

The 5335A is exercised in the Rise and Fall Time mode.

Table 4-5. 9825A Program Printout (Continued)

CHECK POINT 12
OVERFLOW Test.

Verify ONLY
lamps lit during
the 11 seconds
wait period:

*FREQ A
*GATE MODE
Manual
*'Hz'
*'GATE'
*'LISTEN'
*'REMOTE'
*'A' triesser
lamp (flashina)
5335A Display:
'0.'

Verify:
Same as above
except---
*5335A displays
+10.0000000000 +6
(actual)
*'LISTEN'
lamp is OFF
*'GATE'
lamp is OFF
*'TALK'
lamp is ON.

CHECK POINT 12 exercises the "gate open" and
"gate closed" functions.

Table 4-5. 9825A Program Printout (Continued)

CHECK POINT 13
TIME INTERVAL
Test.

VERIFY:
*TIME A+B
 lamp is ON
*5335A displays
 approximately
 50 nanoseconds
*Gate Mode MIN
 lamp is ON
*'GATE' lamp
 flashing
*'A' and 'B'
 trigger lamps
 flashing
*'LISTEN'
 lamp ON
*'REMOTE'
 lamp ON.

The 5335A is programmed in the TIME A→B function.

INVERSE TIME
INTERVAL Test.
VERIFY:
*1/TIME A+B
 lamp is ON
*5335A displays
 approximately
 20. +6
*Gate Mode MIN
 lamp is ON
*'GATE' lamp
 flashing
*'A' and 'B'
 trigger lamps
 flashing
*'LISTEN'
 lamp ON
*'REMOTE'
 lamp ON.

The INVERSE TIME A→B is exercised; the actual displayed value may differ.

Table 4-5. 9825A Program Printout (Continued)

CHECK POINT 14
FRONT PANEL
Switch Test.

Press each
momentary type
key on the 5335A
front panel,
beginning with
upper left key
(MATH DISABLE)
and go down each
column.

Press CONTINUE
to perform test.

A number will be
displayed when
a key is pressed
corresponding to
FIGURE A.

Programs the 5335A for Diagnostic #17.

Figure A

MATH			
01	03	05	07

STATISTICS			
02	04	06	08

FUNCTION				
09	13	17	21	25
10	14	18	22	26
11	15	19	23	27
12	16	20	24	28

GATE MODE		
29	31	33

CYCLE		
30	32	34

Table 4-5. 9825A Program Printout (Continued)

CHECK POINT 15
FRONT END Test.

VERIFY:

- *All display annunciator lamps turn ON for about 5 seconds
- *5335A displays 'FE PASS' for about 15 seconds
- *Then 5335A will display:
the voltages at A2U4(2,12,10);
NOMINAL values are:
5. 000 00 V
3. 100 00 V
-5. 200 00 V

} The 5335A is programmed to fully test the front end by connecting the Time Base Out to INPUT A.

Table 4-5. 9825A Program Printout (Continued)

CHECK POINT 16
OPTION 020 Test.

SETUP:
Connect Trigger
Level 'A' from
rear panel to
DVM input jack;
set PRESET 'A'
off, but in CCW
Position.

Verify that
5335A displays
approximately
-5.XXX Volts.

Rotate 'A' level
control CW
and check
that display is
about the same
as before with
opposite sign.

The 5335A is set up to verify the proper operation of
the DVM, Option 020.

CHECK POINT 17
OPTION 030 Test.

SETUP:
Connect an
86603A to 5335A
'C' Input and
8660C TBO to
5335A Time
Base In.

Verify that
5335A displays
the frequency of
the 8660C.
(150MHz+1.3GHz)

Programs and verifies the correct operation of the
Channel C, Option 030.

END OF TEST.

Table 4-6. HP-IB Verification Program Listing

```

0: dim A$(32),F$(21),C$(16),D$(16),E$(40),F$(21),A(30)
1: "CHECK POINT1 --Press CONTINUE."->A$
2: "-----">D$;"*****">C$
3: "Press CONTINUE to perform test."->E$;0->X+Y
4: "code":ent "Select code?",S
5: if S=721;dsp "Error: calculator address";wait 2000;gto "code"
6: if S>730;dsp "Out of address range + high";wait 2000;gto "code"
7: if S<700;dsp "Out of address range + low";wait 2000;gto "code"
8: dev "sj",S;prt C$;spc
9: prt "5335A UNIVERSAL","COUNTER HP-IB"
10: prt "Verification","Program.";spc ;prt C$;spc 2
11: prt "SETUP:","both chans","50 ohms,X1,DC","all slopes=pos,"
12: prt "levels = preset","sep/corr A=com A","Auto Trig. ON,"
13: prt "Gate Adj.=","full ccw.";spc
14: prt "CONNECT:","Time Base Out","from rear panel","to INPUT A.";spc 2
15: prt A$(18);spc 2;dsp "5335A UNIVERSAL COUNTER Test.";stp
16: prt "Turn 5335A power","OFF then ON.";spc 2
17: "1":dsp A$(1,11)," 1"
18: prt D$;wrt 16,A$(1,13),"1"
19: prt "5335A front","panel set-up","check. Verify:"
20: prt "*RED LED 'STBY'," lamp is OFF"
21: prt "*All display"," annunciator"," lamps turn ON"
22: prt " momentarily"," (excluding"," 'STBY' and"," trigger lamps)"
23: prt "*Display shows"," the selected"," HP-IB address"
24: prt " for about 1 sec"
25: prt "*Display then"," shows '0.'"," momentarily;"
26: prt " Furtion FREQ A"," and Hz annun."
27: prt " lamps are 0"," Then 5335A will"," display:"
28: prt " 10. 000 000 +6"," with 'Hz' LED"," ON; 'GATE', 'A'"
29: prt " and 'E' Trigger"," lites flashing.";spc 2
30: dsp A$(1,11)," 1",A$(16);stp
31: if X=1;gto "rpt"
32: "2":dsp A$(1,11)," 2"
33: prt D$;wrt 16,A$(1,13),"2"
34: prt "Program sends","5335A 'listen',"address.";spc
35: prt "Verify:","Display is same","as above except","'LISTEN' and"
36: prt "'REMOTE',"annunciators","are lit.";spc 2
37: wrt "sj"
38: dsp A$(1,11)," 2",A$(16);stp
39: if X=1;gto "rpt"
40: "3":dsp A$(1,11)," 3"
41: prt D$;wrt 16,A$(1,13),"3"
42: prt "Program sends","5335A talk","address. Verify:"
43: prt "Display is same","as CHECK POINT 1"
44: prt "except 'TALK',"and 'REMOTE',"annunciators","are lit.";spc 2
45: red "sj",B$;dsp A$(1,11)," 3",A$(16);stp
46: prt "OUTPUT test:","Verify:","Same reading on","calculator","display"
47: prt "as on 5335A","display.,"(Available for","10 seconds.);spc 2
48: dsp E$;stp
49: for I=1 to 30;red "sj",B$;dsp B$;next I;spc 2
50: dsp A$(1,11)," 3",A$(16);stp
51: if X=1;gto "rpt"
52: "4":dsp A$(1,11)," 4"
53: prt D$;wrt 16,A$(1,13),"4"

```

Table 4-6. HP-IB Verification Program Listing (Continued)

```
54: prt "Press LOC/RESET","on 5335A.,""Verify: 'REMOTE',"LED goes out."
55: spc 2
56: dsp AS[1,11]," 4",AS[15];stp
57: if X=1;gto "rpt"
58: "5":dsp AS[1,11]," 5"
59: prt DS;wrt 16,AS[1,13],"5"
60: prt "Program sets","5335A in the","local-lockout","mode."
61: prt "Press LOC/RESET","on the 5335A and","verify that","'REMOTE' LED"
62: prt "stays ON.";spc 2
63: wrt "sj";llo 7
64: dsp AS[1,11]," 5",AS[16];stp
65: if X=1;gto "rpt"
66: "6":dsp AS[1,11]," 6"
67: prt DS;wrt 16,AS[1,13],"6"
68: prt "Program sets","5335A in the","WAIT and","SERVICE REQUEST","mode."
69: spc
70: prt "Verify that the","following LEDs","are lit during"
71: prt "five (5)","measurements:"
72: prt "* TALK","* LISTEN","* SRQ","* REMOTE";spc 2;stp ;dsp ES
73: lcl "sj";wrt "sj","walsrl";0+I
74: oni 7,"SRQ"
75: eir 7
76: gto -1;if I>5;gto 82
77: "SRQ":for I=1 to 5
78: if bit(6,rds("sj"));red "sj",BS;dsp BS
79: wrt "sj","re";wait 1000
80: next I
81: iret
82: dsp AS[1,11]," 6",AS[16];beep;stp
83: if X=1;gto "rpt"
84: "7":dsp AS[1,11]," 7"
85: prt DS;wrt 16,AS[1,13],"7"
86: prt "TEACH-LEARN Test";spc
87: prt "Verify that the","5335A displays","11. 224 49 +15 Hz.";spc 2
88: dsp ES;stp
89: rem "sj";wrt "sj","fulms1122449800"
90: prt "5335A will teach","the 9825A the","front panel","setup.";spc 2
91: wrt "sj","pb"
92: for I=1 to 30
93: rdb("sj")→A[I];next I
94: gto -1;if A[24]=17 and A[25]=34;gto +1
95: gto -2;if A[26]=68 and A[27]=136 and A[28]=0 and A[29]=0;gto +1
96: dsp "5335A → 9825A ",AS[18];stp
97: wrt "sj","fu9";0+I
98: prt "Verify that the","5335A displays","100. 000 00 -9"
99: prt "with 'S' and","Function PER A","lites ON, and"
100: prt "'GATE' LED fla-","shing."
101: wrt "sj","re";lcl "sj"
102: spc 2;dsp AS[1,11],"7",AS[16];stp
103: prt "5335A will learn","from 9825A.,"Verify that the"
104: prt "5335A displays","11. 224 49 +15 Hz.";spc 2
105: wtb "sj","pb";for I=1 to 30;wtb "sj",A[I];next I;lcl "sj"
106: dsp "9825A → 5335A ",AS[18];stp
107: if X=1;gto "rpt"
108: "8":dsp AS[1,11]," 8"
109: prt DS;wrt 16,AS[1,13],"8"
110: prt "FREQ B Test.";spc ;prt "SETUP:","Connect TBO from","rear panel to"
```

Table 4-6. HP-IB Verification Program Listing (Continued)

```

111: prt "INPUT B. ";spc 2;dsp AS[1,11]," 8",AS[16];stp
112: prt "VERIFY:","*5335A displays"," 10. 000 000 +6","*'Hz' lamp ON"
113: prt "'GATE' lamp"," flashing","*'LISTEN' and"
114: prt " 'REMOTE' lamps"," are lit","*All FUNCTION"," lamps OFF"
115: prt "'B' trigger"," light flashing.";spc 2
116: wrt "sj","in,ful7"
117: dsp AS[1,11]," 8",AS[16];stp
118: if X=1;gto "rpt"
119: "9":dsp AS[1,11]," 9"
120: prt DS;wrt 16,AS[1,13],"9"
121: prt "TRIG LEVEL Test.";spc
122: wrt "sj","ful4";red "sj",BS,FS
123: prt "Program sets","Trig lvl funct.";spc ;prt "VERIFY:"
124: wrt 16,"Trigger Level A="
125: wrt 16,BS[11,15],"V (actual)";spc
126: prt "Triqger Level B="
127: wrt 16,FS[11,15],"V (actual)";spc 2
128: dsp AS[1,11]," 9",AS[16];stp
129: if X=1;gto "rpt"
130: "10":dsp AS[1,11],"10";prt DS;wrt 16,AS[1,13],"10"
131: prt "GATE TIME Test.";spc
132: prt "GATE ADJ. Normal","Range test.,"Vary 'GATE ADJ.'"
133: prt "pot and verify","change in Gate","Time displayed","NOMINALLY,"
134: prt "between 20","milliseconds","and 4 seconds.";spc 2
135: wrt "sj","ful3gm0rh0";dsp AS[1,11],"10",AS[16];stp
136: prt "GATE ADJ. Fast","Range test.,"Vary 'GATE ADJ.'"
137: prt "pot and verify","change in Gate","Time displayed","NOMINALLY,"
138: prt "between 100","microseconds","and 20 milli-","seconds.";spc 2
139: wrt "sj","ful3gmlrh0"
140: dsp AS[1,11],"10",AS[16];stp
141: if X=1;gto "rpt"
142: "11":prt DS;wrt 16,AS[1,13],"11";dsp AS[1,11],"11"
143: prt "RISE/FALL TIME","Test.";spc
144: prt "SETUP:","Connect TBO from","rear panel to","INPUT A.";spc 2
145: dsp ES;stp
146: dsp AS[1,11],"11";prt "RISE TIME test."
147: prt "VERIFY:","*RISE/FALL A"," lamp is ON"
148: prt "*5335A displays"," approximately"," 30 nanoseconds"
149: prt "*Gate Mode MIN"," lamp is ON","*'GATE' lamp"," flashing"
150: prt "'A' and 'B'"," trigger lamps"," flashing","*'LISTEN'"
151: prt " lamp ON","*'REMOTE'," lamp ON.";spc 2
152: wrt "sj","inful0";wait 3000
153: dsp AS[1,11],"11",AS[16];stp
154: dsp AS[1,11],"11";prt "FALL TIME test."
155: prt "Verify: 5335A","display is about","the same as for"
156: prt "Rise Time test.";spc 2
157: wrt "sj","asl";wait 3000
158: dsp AS[1,11],"11",AS[16];stp
159: if X=1;gto "rpt"
160: "12":dsp AS[1,11],"12";prt DS;wrt 16,AS[1,13],"12"
161: prt "OVERFLOW Test.";spc
162: prt "Verify ONLY","lamps lit during","the 11 seconds","wait period:"
163: prt "*FREQ A","*GATE MODE"," Manual","*'Hz'","*'GATE'","*'LISTEN'"
164: prt "'REMOTE',"*"A' trigger"," lamp (flashing)"
165: prt "5335A Display:","0.";spc 2
166: dsp ES;stp
167: wrt "sj","inqm3qo";dsp AS[1,11],"12";wait 11000;wrt "sj","gc"

```

Table 4-6. HP-IB Verification Program Listing (Continued)

```
158: red "sj",BS
169: prt "Verify:","Same as above","except---","*5335A displays"
170: wrt 16,BS[3,15]," +",BS[19];prt " (actual)"
171: prt "*LISTEN"," lamp is OFF","*GATE"," lamp is OFF"
172: prt "*TALK"," lamp is ON. ";spc 2
173: dsp AS[1,11],"12",AS[16];stp
174: if X=1;gto "rpt"
175: "13":dsp AS[1,11],"13";prt DS;wrt 16,AS[1,13],"13"
176: prt "TIME INTERVAL","Test. ";spc
177: prt "VERIFY:","*TIME A>B"," lamp is ON"
178: prt "*5335A displays"," approximately"," 50 nanoseconds"
179: prt "*Gate Mode MIN"," lamp is ON","*GATE lamp"," flashing"
180: prt "*A' and 'B'," trigger lamps"," flashing","*LISTEN"
181: prt " lamp ON","*REMOTE"," lamp ON. ";spc 2
182: wrt "sj","infu2bslcol";dsp AS[1,11],"13",AS[16];stp
183: dsp AS[1,11],"13";prt "INVERSE TIME","INTERVAL Test."
184: prt "VERIFY:","*1/TIME A>B"," lamp is ON"
185: prt "*5335A displays"," approximately"," 20. +5"
186: prt "*Gate Mode MIN"," lamp is ON","*GATE lamp"," flashing"
187: prt "*A' and 'B'," trigger lamps"," flashing","*LISTEN"
188: prt " lamp ON","*REMOTE"," lamp ON. ";spc 2
189: wrt "sj","fu6";dsp AS[1,11],"13",AS[16];stp
190: if X=1;gto "rpt"
191: "14":dsp AS[1,11],"14";prt DS;wrt 16,AS[1,13],"14"
192: prt "FRONT PANEL","Switch Test. ";spc
193: prt "Press each","momentary tyoe"
194: prt "key on the 5335A","front panel","beginning with"
195: prt "upper left key","(MATH DISABLE)"
196: prt "and go down each","column. ";spc 2
197: prt ES;dsp " See FIGURE A !!!!!";spc 2;stp
198: wrt "sj","fu99msl7";wait 100;lcl "sj"
199: prt "A number will be","displayed when"
200: prt "a key is pressed","corresponding to"
201: prt "FIGURE A. ";spc 2;dsp AS[1,11],"14",AS[16];stp
202: if X=1;gto "rpt"
203: "15":dsp AS[1,11],"15";prt DS;wrt 16,AS[1,13],"15"
204: prt "FRONT END Test. ";spc
205: prt "VERIFY:","*All display"," annunciator"," lamps turn ON"
206: prt " for about 5"," seconds","*5335A displays"," 'FE PASS'"
207: prt " for about 15"," seconds","*Then 5335A will"," display:"
208: prt " the voltages at A204(2,12,10); NOMINAL values are:"
209: prt " 5. 000 00 V"," 3. 100 00 V"," -5. 200 00 V";spc 2
210: wrt "sj","fu99ms0"
211: dsp AS[1,11],"15",AS[16];stp
212: if X=1;gto "rpt"
213: "16":ent "OPTION 020 (1=Y,0=N) ?",A
214: if A#0 and A#1;gto -1
215: if A=0;gto "17"
216: prt DS;wrt 16,AS[1,13],"16";dsp AS[1,11],"16"
217: prt "OPTION 020 Test. ";spc ;prt "SETUP:","Connect Trigger"
218: prt "Level 'A' from","rear panel to","DV' inout jack;"
219: prt "set PRESET 'A' off, but in CCW position. ";spc
220: prt "Verify that","5335A displays","approximately","-5.XXX Volts."
221: spc 2;dsp ES;stp
222: wrt "sj","fu15"
223: prt "Rotate 'A' level","control CW ","and check"
224: prt "that display is","about the same","as before with"
```

Table 4-6. HP-IB Verification Programs Listing (Continued)

```

225: prt "opposite sign.";snc 2
226: dsp AS[1,11],"16",AS[16];sto
227: if X=1;gto "rpt"
228: "17":ent "OPTION 030 (1=Y,0=N) ?",B
229: if B#0 and B#1;gto -1
230: if B=0;gto "rpt"
231: prt DS;wrt 16,AS[1,13],"17";dsp AS[1,11],"17"
232: prt "OPTION 030 Test.";snc ;prt "SETUP:","Connect an"
233: prt "86603A to 5335A","C' Input and","8660C TPO to"
234: prt "5335A Time","Base In.";snc 2
235: dsp ES;sto
236: wrt "sj","fu5";dsp AS[1,11],"17"
237: prt "Verify that","5335A displays","the frequency of","the 8660C."
238: prt "(150MHz+1.3GHz)";snc 2
239: dsp AS[1,11],"17",AS[16];sto
240: if X=1;gto "rpt"
241: "rpt":ent "Repeat a Check Point (1=Y,0=N) ?",X
242: if X#1 and X#0;gto -1
243: if X=0;gto "end"
244: if X=1;ent "Check Point number (1 thru 17) ?",N
245: if N>17 or N<1;gto -1
246: jmp N
247: gto "1"
248: gto "2"
249: gto "3"
250: gto "4"
251: gto "5"
252: gto "6"
253: gto "7"
254: gto "8"
255: gto "9"
256: gto "10"
257: gto "11"
258: gto "12"
259: gto "13"
260: gto "14"
261: gto "15"
262: gto "16"
263: gto "17"
264: "end":prt "END OF TEST.";beep;snc 6
265: lcl "sj";dsp "END OF TEST."
266: end
*7073

```

Table 4-7. Operational Verification Record

HEWLETT-PACKARD MODEL 5335A UNIVERSAL COUNTER		Date _____	
Test Performed by _____		Serial No. _____	
STEP #	DESCRIPTION	RESULTS	
		PASS	FAIL
V	Power-Up/Self Check	_____	_____
VI	Super Check	_____	_____
VII	Front End Switch Test (INPUT)	_____	_____
VIII	Rear Panel Ext Arm Slope Switch Test	_____	_____
IX	Keyboard Check	_____	_____
X	DVM Test (option 020)	_____	_____
XI	Channel C Test (option 030)	_____	_____

SECTION V ADJUSTMENTS

5-1. INTRODUCTION

5-2. This section describes the adjustments required to maintain the HP 5335A's operating characteristics within specifications. Adjustments should be made when required, such as after a performance test failure or when components are replaced that may affect an adjustment.

5-3. *Table 5-1* lists the adjustment procedures, in the recommended order of performance, and indicates the adjustable components involved.

5-4. EQUIPMENT REQUIRED

5-5. The test equipment required for the adjustment procedures is listed in *Table 1-4*, Recommended Test Equipment. Substitute instruments may be used if they meet the critical specifications.

5-6. FACTORY SELECTED COMPONENTS

5-7. Factory selected components are identified by an asterisk (*) in parts lists and schematic diagrams. Refer to paragraph 8-27 for replacement information.

5-8. ADJUSTMENT LOCATIONS

5-9. Adjustment locations are identified in the procedure for each adjustment.

5-10. SAFETY CONSIDERATIONS

5-11. This section contains warnings that must be followed for your protection and to avoid damage to the instrument.

WARNING

MAINTENANCE DESCRIBED HEREIN IS PERFORMED WITH POWER SUPPLIED TO THE INSTRUMENT, AND PROTECTIVE COVERS REMOVED. SUCH MAINTENANCE SHOULD BE PERFORMED ONLY BY SERVICE-TRAINED PERSONNEL WHO ARE AWARE OF THE HAZARDS INVOLVED (FOR EXAMPLE, FIRE AND ELECTRICAL SHOCK). WHERE MAINTENANCE CAN BE PERFORMED WITHOUT POWER APPLIED, THE POWER SHOULD BE REMOVED.

BEFORE ANY REPAIR IS COMPLETED, ENSURE THAT ALL SAFETY FEATURES ARE INTACT AND FUNCTIONING, AND THAT ALL NECESSARY PARTS ARE CONNECTED TO THEIR PROTECTIVE GROUNDING MEANS.

Table 5-1. Adjustments

Procedure	Assembly	Adjustments	Comments
Power Supply	A1	A1R1, R15	Uses Diagnostic Loop #32
Input Amplifier	A3	A3R37, R47, R88, R96	Uses Special Function Loop #17
D.V.M.	A8	Zero Adj, Ref Sym, Low, Med, High	Allow 20 min warmup Perform adjustments in indicated order
C CHANNEL	A9	A9R22, R23, R24	Allow 5 minutes for warmup
Oscillator	A4/A12	A4C6/FREQ ADJUST	Check against known House Standard
Level Shifter	A2	A2R65, R66	Uses Special Function Loop #17

5-12. ADJUSTMENT PROCEDURES

5-13. Power Supply Adjustment Procedure

5-14. The voltage supplies in the HP5335A that require adjustment are +3 Volts, and +15 Volts. To perform these adjustments, proceed as follows:

- a. Connect the positive terminal of the DVM to A1U4(2) and the negative terminal to chassis ground.
- b. Adjust A1R1 for a DVM reading of 3.100Vdc ($\pm 50\text{mV}$).
- c. Call up Diagnostic routine #32, as follows:
 - Press: SCALE
 - SMOOTH
 - 99
 - ENTER (wait for 5 seconds)
 - SCALE
 - 32
 - ENTER
- d. The 5335A should display 3.078 Vdc ($\pm 70\text{mV}$).
- e. Connect the positive terminal of the DVM to A1U6(3) or the cathode of A1CR2, and the negative terminal to chassis ground.
- f. Adjust A1R15 for a DVM reading of 15.70 Vdc ($\pm 20\text{mV}$ dc).
- g. Turn off the 5335A, and disconnect the test equipment.

5-15. Input Amplifier Adjustment Procedure

5-16. To perform the Offset and Hysteresis adjustments required for A3, proceed as follows:

- a. Remove the 5335A top cover, and locate variable resistors R37, R47, R88, and R96 on the A3 Input Amplifier Assembly (05335-60003). Refer to Assembly Adjustment Locator in *Figure 5-1*, and component locators in Section VIII.
- b. Set the 5335A front panel controls as follows:

```

GATE TIME ..... Adjust to about 150ms
FUNCTION ..... FREQ A
GATE MODE ..... NORM
CYCLE ..... NORM
INPUT (Channels A and B)
  1M ohm/50 ohm ..... 50 ohm
  Trigger Level ..... PRESET
  ATTN ..... X1
  AC/DC ..... DC
  
```

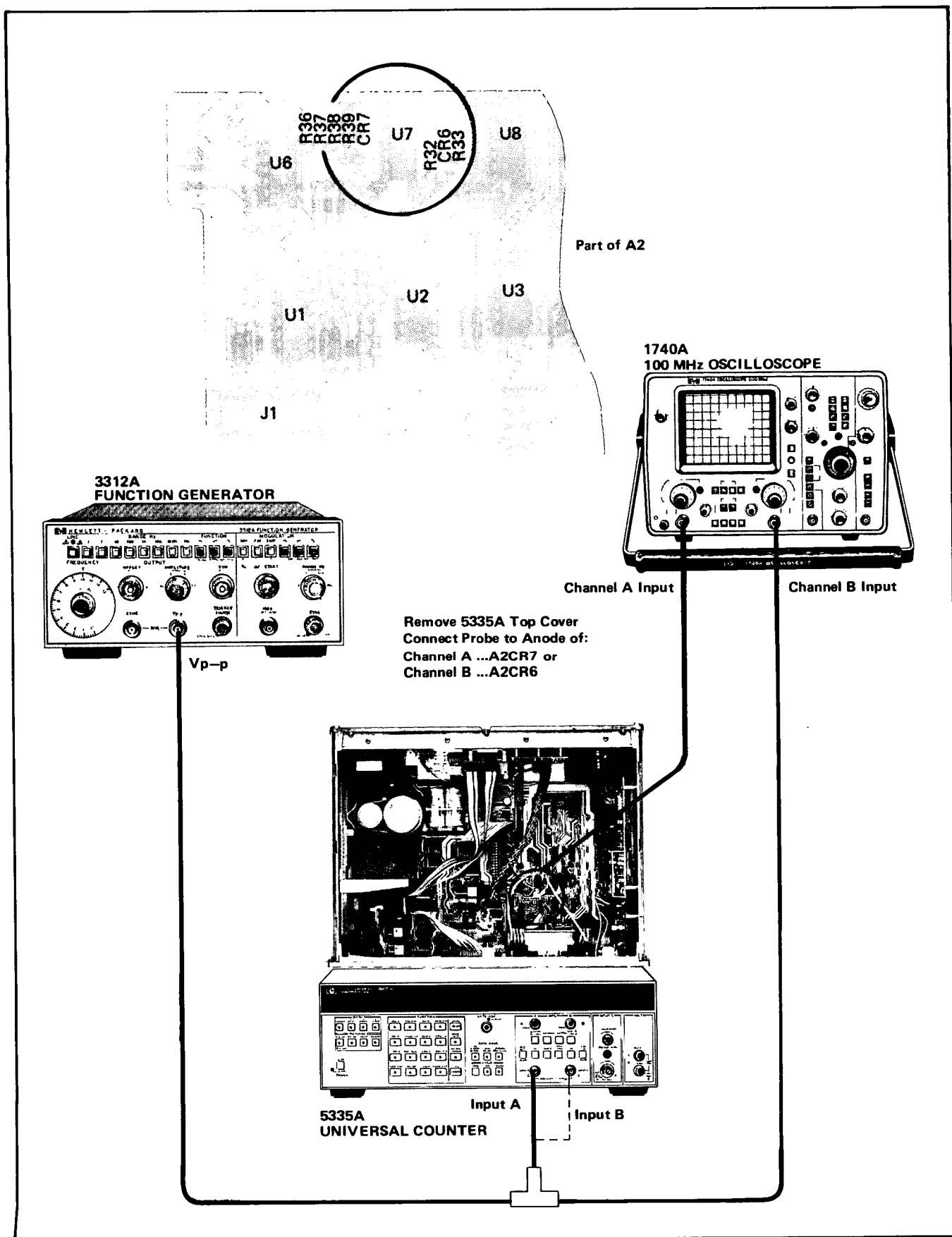

Figure 5-1. Input Amplifier Adjustment Setup.

COM A Out
 AUTO TRIG Out
 POWER STBY/ON ON

- c. Set the 3312A Function Generator to output a 1.0 kHz sine wave at ~100mV p-p.
- d. Connect the test equipment as shown in *Figure 5-1*; for the Channel A adjustment, connect the oscilloscope A channel probe to the anode of A2CR7.

WARNING

DO NOT SHORT THE PROBE TO ANY OTHER TRACES OR COMPONENTS, OR DAMAGE WILL OCCUR TO THE CIRCUITRY, PARTICULARLY TO THE AMP SCHMITT IC'S.

- e. Set the oscilloscope for the X-Y mode, and calibrate by centering the dot at center screen.
- f. Position both A3R96 (offset) and A3R88 (hysteresis) to approximately midrange.
- g. Adjust A3R96 (offset) to position the waveform at the center of the screen. Adjust A3R88 (hysteresis) for 20 mV p-p on the X-axis. Refer to the waveform in *Figure 5-2*.
- h. Disconnect the oscilloscope's A channel probe from A2CR7 and connect the probe to the anode of A2CR6. Disconnect the signal generator's output from the 5335A's Channel A INPUT and connect it to the Channel B INPUT.
- i. Set the 5335A for Special Function #17; (press: SCALE, SMOOTH, 17, ENTER).
- j. Position both A3R47 (offset) and A3R37 (hysteresis) to approximately midrange.
- k. Adjust A3R47 (offset) to position the waveform at the center of the screen. Adjust A3R37 (hysteresis) for 20 mV p-p on the X-axis. Refer to the waveform in *Figure 5-2*. This completes the adjustment of Channel A and B; turn the 5335A off and disconnect all test equipment.

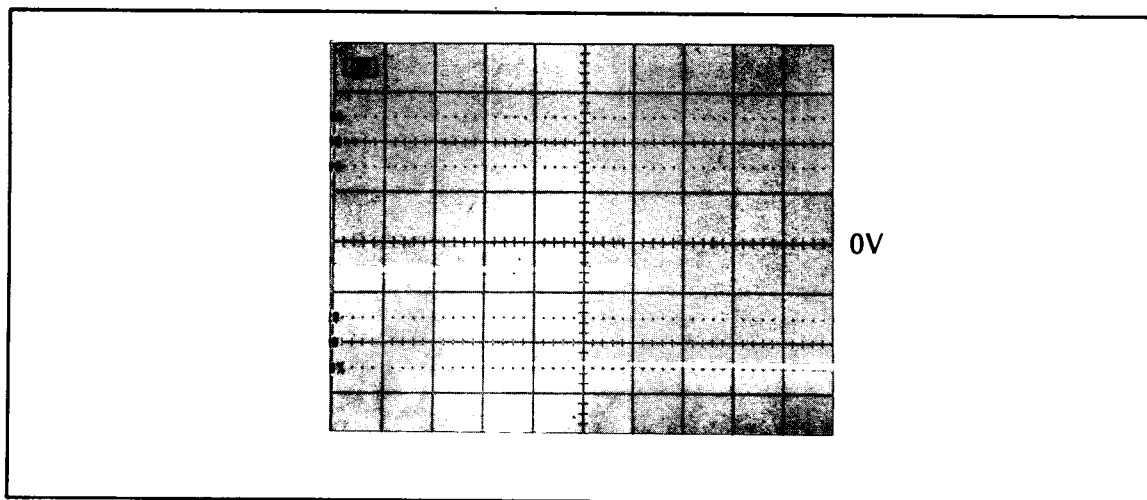

*Figure 5-2. Input Amplifier Adjust Waveform**

* A-Channel: 0.05 mV/cm Y-axis
 (with a 10:1 probe)

* B-Channel: 0.01 mV/cm X-axis

5-17. Digital Voltmeter (Option 020) Adjustment Procedure

- 5-18. To perform the adjustments required for the DVM, proceed as follows:
- a. Turn on 5335A and allow instrument (and voltmeter) to warm-up for 20 minutes.

NOTE

The following adjustments are sequential and should be performed in the order indicated.

- b. Set the 5335A to the VOLTS function, and adjust the GATE TIME for ~150 msec.
- c. Short the HI/LO Volts module inputs together, to force the DVM into the 10 μ V resolution range.
- d. Press DISABLE, N=1000 to get an additional two digits of display. Connect the HP 3455A's negative (Low) lead to the "floating" ground on A8. Connect the positive (Hi) lead to A8 TP1; the reading on the DMM should be 0V ($\pm 5\mu$ V). If not, adjust A8 "ZERO ADJ" for 0V ($+5\mu$ V).
- e. Remove the short between the HI/LO inputs of the Volts module. Set the DC Standard to 4.0000 Volts, and connect it to the Volts module input. Observe and record the 5335A display. Reverse the polarity of the input voltage, and observe and record the negative display. Take the sum of the absolute values of the two readings, and divide by two. Adjust "REF SYM" for a display of that calculated value.
- f. Adjust "LOW" until the 5335A displays 4.0000V ($\pm 100\mu$ V).
- g. Set the DC Standard to 40.000 Volts. Adjust "MED" for a display of 40.000V (± 1 mV).

WARNING

THE FOLLOWING STEP REQUIRES HIGH VOLTAGE. EXTREME CARE SHOULD BE EXERCISED.

- h. Set the DC Standard to 400.000 Volts. Adjust "High" for a display of 400.00V (± 10 mV).
- i. Return the DC Standard to 4.000 Volts, then turn the DC Standard and the 5335A off; disconnect all test equipment.

5-19. Channel C Adjustment Procedure

5-20. To perform the adjustments required for the CHANNEL C, proceed as follows:

- a. Turn on 5335A and allow instrument (and CHANNEL C) to warm-up for 5 minutes.
- b. Remove the instrument top cover and locate variable resistors R22 (L), R23 (H), and R24 (K) on the A9 Channel C Assembly (05335-60009). Refer to the A9 component locator in Section VIII.
- c. Set the 5335A front panel controls as follows:

GATE MODE NORM
 GATE CYCLE NORM
 GATE TIME to about 1.2 sec
 FUNCTION FREQ C
 INPUT C Sensitivity MAX
 (no input signal)

(SELF OSCILLATING ADJUSTMENT)

- d. Set A9R22 (L) to full clockwise position, and adjust A9R23 (H) until the 5335A displays 1010 MHz (± 10 MHz).
- e. Adjust A9R24 (K) for maximum display of frequency. Readjust A9R23 (H) for a display of 1010 MHz (± 10 MHz). Steps d and e may have to be repeated.

(SENSITIVITY ADJUSTMENT)

- f. Connect the instrument as shown in Figure 5-3.
- g. Adjust the Channel C front panel SENSITIVITY control to MAX (fully clockwise).
- h. Set A9R22 (L pot) fully counterclockwise.
- i. Set the 8660C to output a 1 GHz sinewave, varying the 86603A vernier until the HP436A Power Meter reads -24 dBm, ± 0.3 dBm. Adjust A9R22 ("L" pot) clockwise slowly until the 5335C displays 1 GHz (± 1 Hz).
- j. Set the 5335A GATE TIME to about 1.5 seconds.
- k. Set the 8660C to output 1.3 GHz sinewave, varying the 86603A vernier until the HP436A power meter reads -13 dBm (-19 dBm, 50mV rms at the 5335A input). Verify that the counter displays 1.300 000 000 +9 (± 1 Hz).
- l. Turn the 5335A and 8660C off, and disconnect all test equipment.

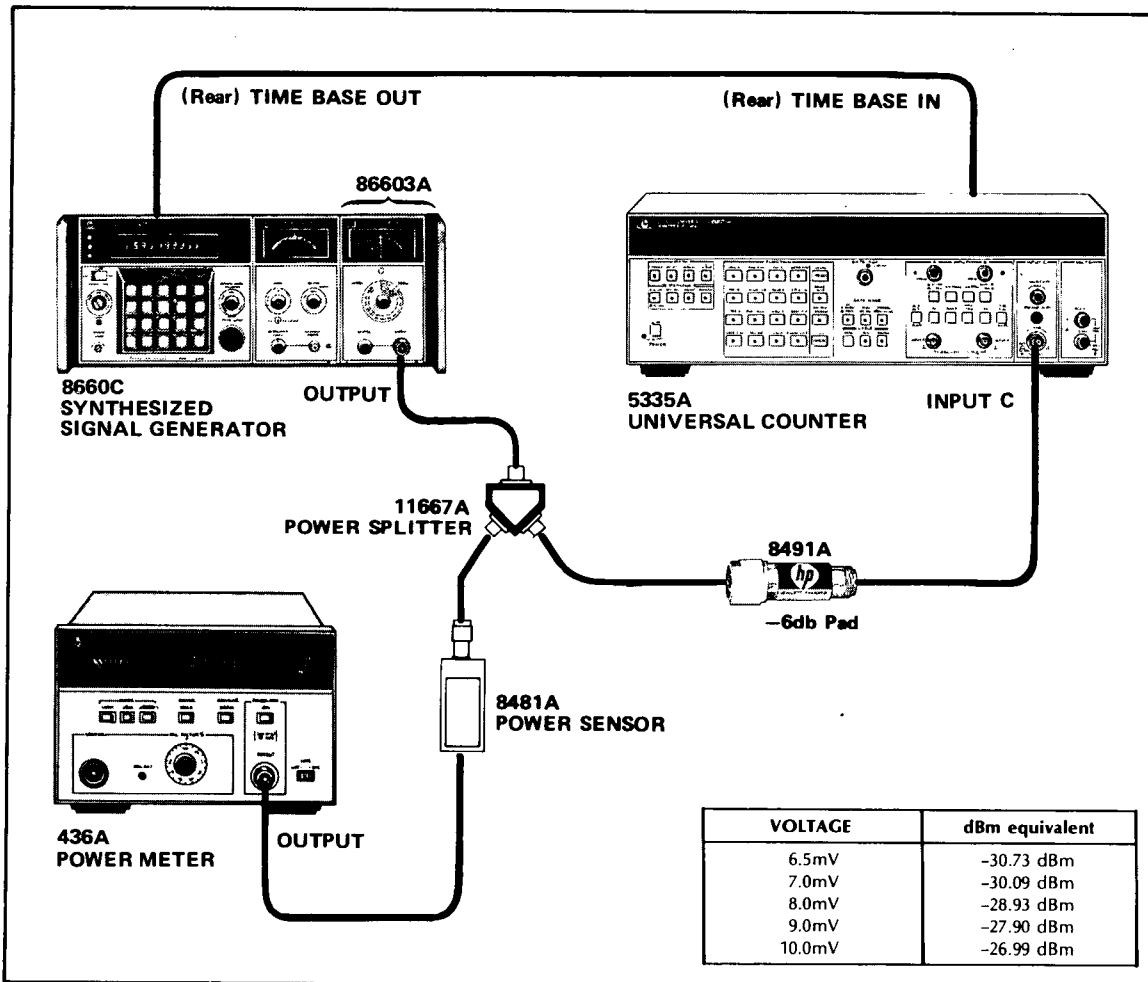

Figure 5-3. Channel C Sensitivity Setup

5-21. Oscillator Adjustment Procedure (Local and Option 010)

5-22. Every few months, the oscillator should be checked to a house standard. When adjustment is required, use the oscilloscope method shown below. When checking the optional oven oscillator, Option 010, allow a 24-hour warmup period before adjustment. To perform the oscillator adjustment, proceed as follows:

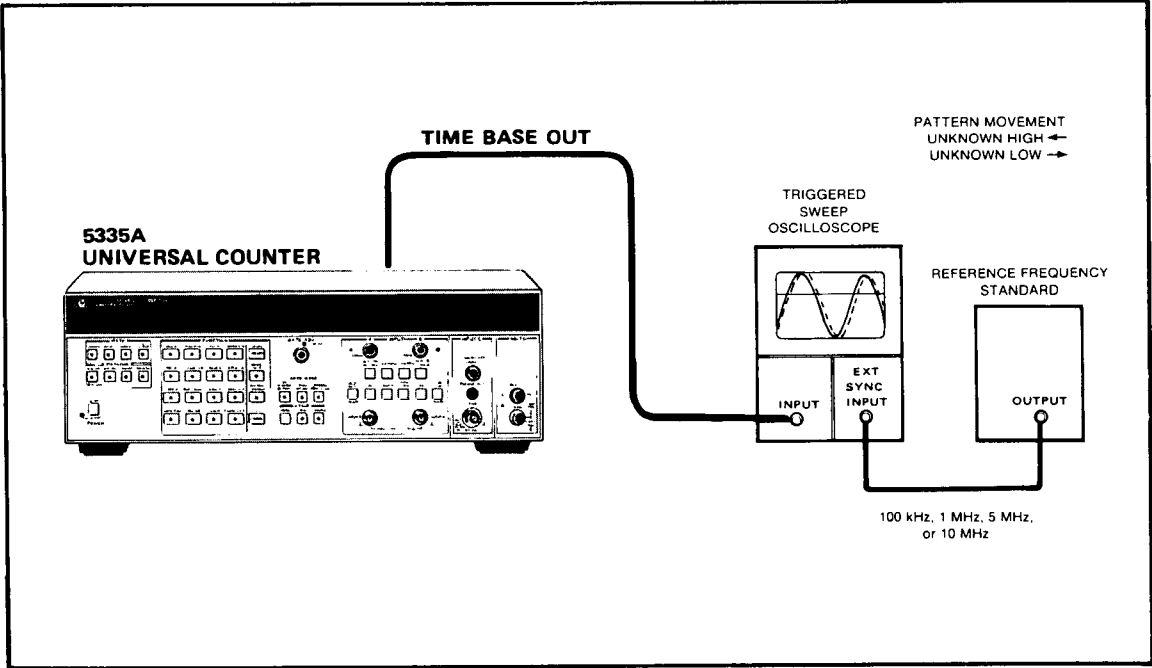

Figure 5-4. Oscillator Adjustment Setup

- a. Connect a reference frequency standard to the external sync input of the oscilloscope.
- b. Connect rear panel TIME BASE OUT of the 5335A to Channel A of the scope.
- c. Adjust the oscillator frequency for the minimum sideways movement of the 10 MHz displayed signal. For the local oscillator, adjust A4C6; for Option 010, HP 10811 Oven Oscillator, adjust the screwdriver adjustment labeled **FREQ ADJ.**
- d. By timing the sideways movement (in CM per second), the approximate frequency offset can be determined based on the oscilloscope sweep speed as shown in the following:

MOVEMENT	SWEEP SPEED			NOTES
	1 $\mu\text{s/cm}$	0.1 $\mu\text{s/cm}$	0.01 $\mu\text{s/cm}$	
1 cm/s	1×10^{-6}	1×10^{-7}	1×10^{-8}	TIME SCOPE TRACE MOVEMENT WITH SECOND HAND OF WATCH OR CLOCK
1 cm/10 s	1×10^{-7}	1×10^{-8}	1×10^{-9}	
1 cm/100 s	1×10^{-8}	1×10^{-9}	1×10^{-10}	

For example, if the trace moves 1 centimetre in 10 seconds and the sweep speed is 0.01 $\mu\text{s/cm}$, the oscillator signal is within 1×10^{-9} of the reference frequency.

5-23. Channel A and B Level Shifter Adjustment Procedure

- 5-24. To perform the adjustments required for the A2 Level Shifter proceed as follows:
- Remove the 5335A top cover and locate variable resistors R65 and R66 on the A2 Amplifier Support Assembly (05335-60002).
 - Connect the 8640B Signal Generator, RF OUTPUT to 5335A INPUT A, and the 8640B TIME BASE OUT to 5335A TIME BASE IN as shown:

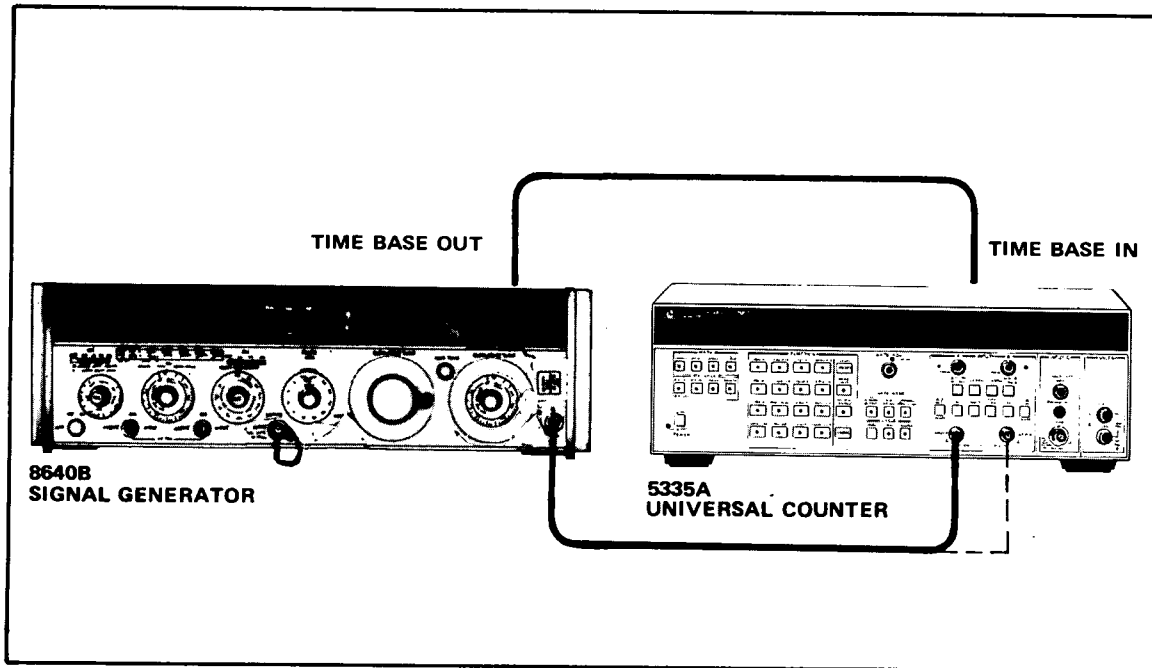

Figure 5-5. Level Shifter Adjustment Set-Up

- c. Set the 5335A front panel controls as follows:

FUNCTION	PER A
GATE MODE	NORM
CYCLE	NORM
INPUT (Channels A and B)	
SLOPE	∇ (negative)
1M/50ohm	50ohm
TRIGGER LEVEL	PRESET
X1/X10 ATTN	X1
AC/DC	DC
COM A	OUT
AUTO TRIG	OUT

- d. Set the 8650B to output a 110 MHz signal at 15mV rms.

NOTE

8640B amplitude may be increased up to 20mV rms if necessary, to obtain stable count within $\pm 2\text{Hz}$.

- e. Press the 5335A GATE TIME key and adjust the GATE ADJ knob to where the 5335A display shows 300 msec. (± 50 msec.) Press the 5335A RESET key to return the function to PER A. Verify the PER A key lamp is ON.

- f. Adjust A2R66 for Channel A to where the 5335A display remains stable at 9.0909091 nanoseconds within ± 2 counts.

NOTE

It may be necessary to vary the GATE ADJ knob to obtain the required resolution (i.e. 9.090909X).

- g. Set Channel A slope to (\uparrow) positive and adjust A2R66 to where the count is stable within ± 2 counts. Display should be stable to within ± 2 counts on both slopes (\downarrow and \uparrow).
- h. Connect the 8640B Signal Generator to 5335A INPUT B. Ensure the 8640B is set to output a 110 MHz signal at 15mV rms.
- i. Set the 5335A to Special Function 17, by pressing: SCALE, SMOOTH, 1, 7, ENTER.
- j. Repeat steps f and g, adjusting A2R65 for Channel B. This completes the Channel A and B level shifter adjustment.
- k. Disconnect all test equipment.

SECTION VI REPLACEABLE PARTS

6-1. INTRODUCTION

6-2. This section contains information for ordering parts. *Table 6-1* lists abbreviations used in the parts list and throughout the manual. *Table 6-2* lists all replaceable parts for the standard 5335A in reference designation order. *Tables 6-3, 6-4, and 6-5* list replaceable parts for Options 010, 020, and 030, respectively. *Table 6-6* contains the names and addresses that correspond with the manufacturer's code numbers.

6-3. ABBREVIATIONS

6-4. *Table 6-1* lists abbreviations used in the parts list, schematics, and throughout the manual. In some cases, two forms of the abbreviation are used, one all in capital letters, and one partial or no capitals. This occurs because the abbreviations in the parts list are always all capitals. However, in the schematics and other parts of the manual, other abbreviations forms are used with lower case and upper case letters.

6-5. REPLACEABLE PARTS

6-6. *Tables 6-2 through 6-5* are the lists of replaceable parts, and are organized as follows:

- a. Electrical assemblies and their components in alphanumeric order by reference designation.
- b. Chassis-mounted parts in alphanumeric order by reference designation.
- c. Miscellaneous parts.

6-7. The information given for each part consists of the following:

- a. The Hewlett-Packard part number.
- b. The part number check digit (CD).
- c. The total quantity (Qty) used in the assembly.
- d. The description of the part.
- e. A typical manufacturer of the part in a five-digit code.
- f. The manufacturer's number for the part.

6-8. The total quantity of each part used within an assembly is given only once at the first appearance of the part number in the list.

6-9. ORDERING INFORMATION

6-10. To order a part listed in the replaceable parts table, quote the Hewlett-Packard part number, indicate the quantity required, and address the order to the nearest Hewlett-Packard office.

6-11. To order a part that is not listed in the replaceable parts table, include the instrument *model number, serial number*, the description and function of the part, and the number of parts required. Address the order to the nearest Hewlett-Packard office.

Table 6-1. Abbreviations and Reference Designations

REFERENCE DESIGNATIONS

A = assembly	DL = delay line	K = relay	T = transformer
AT = attenuator; isolator; termination	DS = annunciator; signaling device (audible or visual); lamp; LED	L = coil; inductor	TB = terminal board
B = fan; motor	E = miscellaneous electrical part	M = metre	TC = thermocouple
BT = battery	F = fuse	MP = miscellaneous mechanical part	TP = test point
C = capacitor	FL = filter	P = electrical connector (movable portion); plug	U = integrated circuit; microcircuit
CP = coupler	H = hardware	Q = transistor; SCR; triode thyristor	V = electron tube
CR = diode; diode thyristor; varactor	HY = circulator	R = resistor	VR = voltage regulator; breakdown diode
DC = directional coupler	J = electrical connector (stationary portion); jack	RT = thermistor	W = cable; transmission path; wire
		S = switch	X = socket
			Y = crystal unit-piezo-electric
			Z = tuned cavity; tuned circuit

ABBREVIATIONS

A = ampere	HD = head	NE = neon	SPST = single-pole, single-throw
ac = alternating current	HDW = hardware	NEG = negative	SSB = single sideband
ACCESS = accessory	HF = high frequency	nF = nanofarad	SST = stainless steel
ADJ = adjustment	HG = mercury	Ni PL = nickel plate	STL = steel
A/D = analog-to-digital	HI = high	N/O = normally open	SQ = square
AF = audio frequency	HP = Hewlett-Packard	NOM = nominal	SWR = standing-wave ratio
AFC = automatic frequency control	HPF = high pass filter	NORM = normal	SYNC = synchronize
AGC = automatic gain control	HR = hour (used in parts list)	NPN = negative-positive-negative	T = timed (slow-blow fuse)
AL = aluminum	HV = high voltage	NPO = negative-positive zero (zero temperature coefficient)	TA = tantalum
ALC = automatic level control	Hz = hertz	NRRFR = not recommended for field replacement	TC = temperature compensating
AM = amplitude modulation	IC = integrated circuit	ns = nanosecond	TD = time delay
AMPL = amplifier	ID = inside diameter	NSR = not separately replaceable	TERM = terminal
APC = automatic phase control	IF = intermediate frequency	nW = nanowatt	TFT = thin-film transistor
ASSY = assembly	IMPG = impregnated	OBD = order by description	TGL = toggle
AUX = auxiliary	in = inch	OD = outside diameter	THD = thread
AVG = average	INCD = incandescent	OH = oval head	THRU = through
AWG = american wire gauge	INCL = include(s)	OP AMPL = operational amplifier	Ti = titanium
BAL = balance	INP = input	OPT = option	TOL = tolerance
BCD = binary coded decimal	INS = insulation	OSC = oscillator	TRIM = trimmer
BD = board	INT = internal	OX = oxide	TSTR = transistor
BE CU = beryllium copper	kg = kilogram	oz = ounce	TTL = transistor-transistor logic
BFO = beat frequency oscillator	kHz = kilohertz	Ω = ohm	TV = television
BH = binder head	kΩ = kilohm	P = pound (used in parts list)	TVI = television interference
BKDN = breakdown	kV = kilovolt	PAM = pulse-amplitude modulation	TWT = traveling wave tube
BP = bandpass	lb = pound	PC = printed circuit	U = micro (10 ⁻⁶) used in parts list
BPF = bandpass filter	LC = inductance-capacitance	PCM = pulse-code modulation; pulse-count modulation	UF = microfarad (used in parts list)
BRS = brass	LED = light-emitting diode	PD = pulse-duration modulation	UHF = ultrahigh frequency
BWO = backward-wave oscillator	LF = low frequency	pF = picofarad	UNREG = unregulated
CAL = calibrate	LG = long	PH BRZ = phosphor bronze	V = volt
CAL = counterclockwise	LH = left hand	PHL = phillips	Va = voltampere
ccw = ceramic	LIM = limit	PIN = positive-intrinsic-negative	Vac = volts ac
CHAN = channel	LIN = linear taper (used in parts list)	PIV = peak inverse voltage	VAR = variable
cm = centimeter	lin = linear	pk = peak	VCO = voltage-controlled oscillator
CMO = coaxial	LK WASH = lockwasher	PL = phase lock	Vdc = volts dc
COEF = coefficient	LO = low; local oscillator	PLO = phase lock oscillator	VDCW = volts, dc, working (used in parts list)
COM = common	LOG = logarithmic taper (used in parts list)	PM = phase modulation	V(F) = volts, filtered
COMP = composition	log = logarithm(ic)	PMP = positive-negative-positive	VFO = variable-frequency oscillator
COMPL = complete	LPF = low pass filter	P/O = part of	VHF = very-high frequency
CONN = connector	LV = low voltage	POLY = polystyrene	Vpk = volts peak
CRP = cadmium plate	m = metre (distance)	PORC = porcelain	Vp-p = volts peak-to-peak
CRT = cathode-ray tube	mA = milliampere	POS = positive; position(s) (used in parts list)	Vrms = volts rms
CTL = complementary transistor logic	MAX = maximum	POT = potentiometer	VSWR = voltage standing wave ratio
CW = continuous wave	MQ = megohm	PP = peak-to-peak	VTO = voltage-tuned oscillator
cw = clockwise	MEG = meg (10 ⁶) (used in parts list)	PPM = pulse-position modulation	VTVM = vacuum-tube voltmeter
D/A = digital-to-analog	MET FLM = metal film	PRF = pulse-repetition frequency	V(X) = volts, switched
dB = decibel	MET OX = metal oxide	PRR = pulse repetition rate	W = watt
dBm = decibel referred to 1 mW	MF = medium frequency; microfarad (used in parts list)	ps = picosecond	W/ = with
dc = direct current	MFR = manufacturer	PT = point	WIV = working inverse voltage
deg = degree (temperature interval or difference)	mg = milligram	PTM = pulse-time modulation	WW = wirewound
° = degree (plane angle)	MHz = megahertz	PWM = pulse-width modulation	W/O = without
°C = degree Celsius (centigrade)	mH = millihenry	PWV = peak working voltage	YIG = yttrium-iron-garnet
°F = degree Fahrenheit	mho = conductance	REF = reference	Zo = characteristic impedance
°K = degree Kelvin	MIN = minute (time)	REG = regulated	
DEPC = deposited carbon	min = minute (plane angle)	REPL = replaceable	
DET = detector	... =	.RF = radio frequency	
diam = diameter	MINAT = miniature	RFI = radio frequency interference	
DIA = diameter (used in parts list)	mm = millimetre	RH = round head; right hand	
DIFF AMPL = differential amplifier	MOD = modulator	RLC = resistance-inductance-capacitance	
div = division	MOM = momentary	RMO = rack mount only	
DPDT = double-pole, double-throw	MOS = metal-oxide semiconductor	rms = root-mean-square	
DR = drive	ms = millisecond	RND = round	
DSB = double sideband	MTG = mounting	ROM = read-only memory	
DTL = diode transistor logic	MTR = meter (indicating device)	R&P = rack and panel	
DVM = digital voltmeter	mV = millivolt	RWW = reverse working voltage	
ECL = emitter coupled logic	mVac = millivolt, ac	S = scattering parameter	
EMF = electromotive force	mVdc = millivolt, dc	S ₁₁ = second (time)	
EDP = electronic data processing	mVpk = millivolt, peak	S-B = second (plane angle)	
ELECT = electrolytic	mVp-p = millivolt, peak-to-peak	S-B = slow-blow fuse (used in parts list)	
ENCAP = encapsulated	mVrms = millivolt, rms	SCR = silicon controlled rectifier; screw	
EXT = external	mW = milliwatt	SE = selenium	
F = farad	MUX = multiplex	SECT = sections	
FET = field-effect transistor	MY = mylar	SEMICON = semiconductor	
F/F = flip-flop	μA = microampere	SHF = superhigh frequency	
FH = flat head	μF = microfarad	SI = silicon	
FOL H = fillister head	μH = microhenry	SIL = silver	
FM = frequency modulation	μH = micromho	SL = slide	
FP = front panel	μs = microsecond	SNR = signal-to-noise ratio	
FREQ = frequency	μV = microvolt	SPDT = single-pole, double-throw	
FXD = fixed	μVac = microvolt, ac	SPG = spring	
g = gram	μVdc = microvolt, dc	SR = split ring	
GE = germanium	μVpk = microvolt, peak		
GHz = gigahertz	μVp-p = microvolt, peak-to-peak		
GL = glass	μVrms = microvolt, rms		
GND = ground(ed)	μW = microwatt		
H = henry	nA = nanoampere		
h = hour	NC = no connection		
HET = heterodyne	N/C = normally closed		
HEX = hexagonal			

NOTE

All abbreviations in the parts list will be in upper case.

MULTIPLIERS

Abbreviation	Prefix	Multiple
T	tera	10 ¹²
G	giga	10 ⁹
M	mega	10 ⁶
k	kilo	10 ³
da	deka	10
d	deci	10 ⁻¹
c	centi	10 ⁻²
m	milli	10 ⁻³
μ	micro	10 ⁻⁶
n	nano	10 ⁻⁹
p	pico	10 ⁻¹²
f	femto	10 ⁻¹⁵
a	atto	10 ⁻¹⁸

6-12. DIRECT MAIL ORDER SYSTEM

6-13. Within the USA, Hewlett-Packard can supply parts through a direct mail order system. Advantages of using the system are:

- a. Direct ordering and shipment from the HP Parts Center in Mountain View, California.
- b. No maximum or minimum on any mail order (there is a minimum order amount for parts ordered through a local HP office when the orders require billing and invoicing).
- c. Prepaid transportation (there is a small handling charge for each order).
- d. No invoices — to provide these advantages, a check or money order must accompany each order.

6-14. Mail order forms and specific ordering information is available through your local HP office. Addresses and phone numbers are located at the back of this manual.

6-15. SPECIAL CONSIDERATIONS FOR MATCHED SETS OF COMPONENTS

6-16. Some of the components must be replaced in matched sets, in order to ensure proper operation on the 5335A Universal Counter. On schematics and parts lists (†) indicates the components are part of a matched set. The following is a list of these components, the part numbers, and ordering instructions.

6-17. On A3, the Amplifier Buffer Assembly there are four sets of matched capacitors and six sets of matched diodes.

The capacitors are:

MATCHED SET	LOCATION	PART NO.
C4, C7	B CHANNEL, + PEAK DETECTOR	0160-4931
C5, C8	B CHANNEL, - PEAK DETECTOR	0160-4931
C51, C52	A CHANNEL, + PEAK DETECTOR	0160-4931
C53, C57	A CHANNEL, - PEAK DETECTOR	0160-4931

NOTE

When you order part number 0160-4931 you will receive a set of two matched capacitors. You cannot order them individually.

The diodes are:

MATCHED SET	LOCATION	PART NO.
CR1, CR4, CR5*	B CHANNEL, + PEAK DETECTOR	05335-80003
CR2, CR6, CR7*	B CHANNEL, - PEAK DETECTOR	05335-80003
CR9 - CR12	B CHANNEL BRIDGE LIMITER	05335-80003
CR20 - CR23	A CHANNEL BRIDGE LIMITER	05335-80003
CR24, CR25, CR28*	A CHANNEL, + PEAK DETECTOR	05335-80003
CR26, CR27, CR29*	A CHANNEL, - PEAK DETECTOR	05335-80003

*NOTE

When you order part number 05335-80003 you will receive a set of four matched diodes. They cannot be ordered in sets of three, or individually. To order a set of twenty matched diodes, order part number 05335-80002. To order a set of two matched diodes, order part number 05335-80005. It is preferable to order a matched set of four when replacing sets of three diodes, to be sure all three diodes in the set are matched.

Model 5335A
Replaceable Parts

6-18. On the A9, C Channel Assembly there is one set of matched diodes, located in the Peak Detector circuit. They are:

MATCHED SET	PART NO.
CR5, CR14	05335-80005

NOTE

When you order part number 05335-80005 you will receive a set of two matched diodes. They cannot be ordered individually. Refer to the (*) footnote in paragraph 6-17 for more information on ordering these diodes.

Table 6-2. Replaceable Parts

Reference Designation	HP Part Number	C D	Qty	Description	Mfr Code	Mfr Part Number
A1	05335-60001	7	1	BOARD ASSEMBLY=POWER SUPPLY	28480	05335-60001
A1C1	0180-1746	5	3	CAPACITOR-FXD 15UF+-10% 20VDC TA	56289	1500156X902082
A1C2	0180-2865	1	1	CAPACITOR-FXD 100UF+100-10% 15VDC AL	28480	0180-2865
A1C3	0180-1701	2	1	CAPACITOR-FXD 6.8UF+-20% 6VDC TA	56289	1500685X0006A2
A1C4	0180-0230	0	3	CAPACITOR-FXD 1UF+-20% 50VDC TA	56289	1500105X0050A2
A1C5	0160-220A	4	2	CAPACITOR-FXD 330PF +-5% 300VDC MICA	28480	0160-2208
A1C6	0180-1746	5		CAPACITOR-FXD 15UF+-10% 20VDC TA	56289	1500156X902082
A1C7	0180-0230	0		CAPACITOR-FXD 1UF+-20% 50VDC TA	56289	1500105X0050A2
A1C8	0160-3879	7	1	CAPACITOR-FXD .01UF +-20% 100VDC CER	28480	0160-3879
A1C9	0160-220A	4		CAPACITOR-FXD 330PF +-5% 300VDC MICA	28480	0160-2208
A1C10	0180-1746	5		CAPACITOR-FXD 15UF+-10% 20VDC TA	56289	1500156X902082
A1C11	0180-0230	0		CAPACITOR-FXD 1UF+-20% 50VDC TA	56289	1500105X0050A2
A1C12	0180-2350	0	2	CAPACITOR-FXD 9600UF+75-10% 25VDC AL	00853	500962U026AD2A
A1C13	0180-2350	0		CAPACITOR-FXD 9600UF+75-10% 25VDC AL	00853	500962U026AD2A
A1C14	0180-2799	0	1	CAPACITOR-FXD .017F+75-10% 20VDC AL	28480	0180-2799
A1C15	0160-4557	0	1	CAPACITOR-FXD .1UF +-20% 50VDC CER	16299	CAC04X7H104M050A
A1C16	0180-0567	6	1	CAPACITOR-FXD 8000UF+75-10% 30VDC AL	00853	500802U030AB2B
A1CR1	1902-0940	2	2	DIODE-ZNR 1N5339B 5.6V 5% PD=5W IR=1UA	28480	1902-0940
A1CR2	1902-0632	9	1	DIODE-ZNR 1N5354B 17V 5% PD=5W TC=+75C	04713	1N5354B
A1CR3	1902-0940	2		DIODE-ZNR 1N5339B 5.6V 5% PD=5W IR=1UA	28480	1902-0940
A1CR4	1901-0662	3	1	DIODE-PWR RECT 100V 6A	04713	MR751
A1CR6	1901-0731	7	1	DIODE-PWR RECT 400V 1A	28480	1901-0731
A1CR7	1901-0050	3	2	DIODE-SWITCHING 80V 200MA 2NS DO-35	28480	1901-0050
A1CR8	1906-0096	7	1	DIODE-FW BRDG 200V 2A	04713	MDA202
A1CR9	1901-0673	6	2	DIODE-PWR RECT 100V 5A 5UB	03508	A15A
A1CR11	1906-0213	0	1	DIODE-SW RECT 200V 12A	01295	TIR101B
A1CR12	1901-0050	3		DIODE-SWITCHING 80V 200MA 2NS DO-35	28480	1901-0050
A1CR10	1901-0673	6		DIODE-PWR RECT 100V 5A 5UB	03508	A15A
A1F1	2110-0010	9	1	FUSE 5A 250V NTD 1.25X.25 UL	75915	312005
A1F2	2110-0043	8	2	FUSE 1.5A 250V NTD 1.25X.25 UL	28480	2110-0043
A1F3	2110-0083	6	1	FUSE 2.5A 250V NTD 1.25X.25 UL	28480	2110-0083
A1F4	2110-0043	8		FUSE 1.5A 250V NTD 1.25X.25 UL	28480	2110-0043
A1J1	1251-6608	0	1	CONNECTOR 16-PIN M POST TYPE NOT ASSIGNED	28480	1251-6608
A1J2						
A1J3	1251-0600	0	9	CONNECTOR-SGL CONT PIN 1.14-MM-BSC-SZ SQ	28480	1251-0600
A1J4	1251-0600	0		CONNECTOR-SGL CONT PIN 1.14-MM-BSC-SZ SQ	28480	1251-0600
A1J5	1251-0600	0		CONNECTOR-SGL CONT PIN 1.14-MM-BSC-SZ SQ	28480	1251-0600
A1J6	1251-0600	0		CONNECTOR-SGL CONT PIN 1.14-MM-BSC-SZ SQ	28480	1251-0600
A1J7	1251-0600	0		CONNECTOR-SGL CONT PIN 1.14-MM-BSC-SZ SQ	28480	1251-0600
A1J8	1251-0600	0		CONNECTOR-SGL CONT PIN 1.14-MM-BSC-SZ SQ	28480	1251-0600
A1J9	1251-0600	0		CONNECTOR-SGL CONT PIN 1.14-MM-BSC-SZ SQ	28480	1251-0600
A1J10	1251-0600	0		CONNECTOR-SGL CONT PIN 1.14-MM-BSC-SZ SQ	28480	1251-0600
A1J11	1251-0600	0		CONNECTOR-SGL CONT PIN 1.14-MM-BSC-SZ SQ	28480	1251-0600
A1K1	0490-1172	8	1	RELAY 6A 24VDC-COIL 5A 115VAC	28480	0490-1172
A1Q1	1853-0454	8	1	TRANSISTOR PNP SI DARL TO=220AB PD=2W	01295	TIP106
A1Q2	1853-0036	2	1	TRANSISTOR PNP SI PD=310MW FT=250MHZ	28480	1853-0036
A1Q3	1854-0215	1	1	TRANSISTOR NPN SI PD=350MW FT=300MHZ	04713	2N3904
A1R1	2100-3212	8	1	RESISTOR-TRMR 200 10% C TOP=ADJ 1-TRN	28480	2100-3212
A1R2	0812-0019	4	1	RESISTOR .33 5% 3W PW TC=0+-90	28480	0812-0019
A1R3	0757-0401	0	1	RESISTOR 100 1% .125W F TC=0+-100	24546	C4=1/8-T0=101-F
A1R4	0698-0063	4	1	RESISTOR 5.23K 1% .125W F TC=0+-100	91637	C4=1/8-T1=5231-F
A1R5	0757-0402	9	1	RESISTOR 10K 1% .125W F TC=0+-100	24546	C4=1/8-T0=1002-F
A1R6	0757-0280	3	4	RESISTOR 1K 1% .125W F TC=0+-100	24546	C4=1/8-T0=1001-F
A1R7	0812-0045	6	1	RESISTOR .15 5% 3W PW TC=0+-90	28480	0812-0045
A1R8	0757-0438	3	1	RESISTOR 5.11K 1% .125W F TC=0+-100	24546	C4=1/8-T0=5111-F
A1R9	0698-4002	9	1	RESISTOR 5K 1% .125W F TC=0+-100	24546	C4=1/8-T0=5001-F
A1R10	0757-0280	3		RESISTOR 1K 1% .125W F TC=0+-100	24546	C4=1/8-T0=1001-F
A1R11	0698-0084	9	2	RESISTOR 2.15K 1% .125W F TC=0+-100	24546	C4=1/8-T0=2151-F
A1R12	0698-0084	9		RESISTOR 2.15K 1% .125W F TC=0+-100	24546	C4=1/8-T0=2151-F
A1R13	0757-0280	3		RESISTOR 1K 1% .125W F TC=0+-100	24546	C4=1/8-T0=1001-F
A1R14	0757-0280	3		RESISTOR 1K 1% .125W F TC=0+-100	24546	C4=1/8-T0=1001-F
A1R15	2100-3383	4	1	RESISTOR-TRMR 50 10% C TOP=ADJ 1-TRN	28480	2100-3383
A1R16	0757-0421	4	1	RESISTOR 825 1% .125W F TC=0+-100	24546	C4=1/8-T0=825R-F
A1TP1	1251-4707	6	2	CONNECTOR-SGL CONT PIN .031-IN-BSC-SZ	28480	1251-4707
A1TP2	1251-4707	6		CONNECTOR-SGL CONT PIN .031-IN-BSC-SZ	28480	1251-4707
A1U1	1826-0316	4	1	V REF TO=5	27014	LH0070=1M
A1U2	1826-0477	6	2	IC OP AMP GP 8-DIP-P	18324	LM301AN
A1U3	1826-0477	6		IC OP AMP GP 8-DIP-P	18324	LM301AN
A1U4	1826-0393	7	1	IC V RGLTR TO=220	27014	L4317T
A1U6	1826-0607	6	1		28480	1826-0607

See introduction to this section for ordering information
*Indicates factory selected value

Table 6-2. Replaceable Parts (Continued)

Reference Designation	HP Part Number	C D	Qty	Description	Mfr Code	Mfr Part Number
A1U7	1826-0214	1	1	IC V RGLTR TO-220	04713	MC7915CT
A1XA2P2	1251-2160	1	1	CONNECTOR-PC EDGE 6-CONT/ROW 2-ROWS	28480	1251-2160
A1X41	0490-0468	3	1	SOCKET-RLY 16-CONT CRADLE DIP-SLDR	28480	0490-0468
				A1 MISCELLANEOUS PARTS		
	0360-0353	0	2	BRACKET-RTANG .406-LG X .343-LG .312-WD	28480	0360-0353
	05335-00005	5	1	HEAT SINK	28480	05335-00005
	1530-109A	4	2	CLEVIS 0.070-IN W SLT; 0.454-IN PIN CTR	00000	ORDER BY DESCRIPTION
	2110-0269	0	8	FUSEHOLDER-CLIP TYPE 5A .250-FUSE	28480	2110-0269

See introduction to this section for ordering information
*Indicates factory selected value

Table 6-2. Replaceable Parts (Continued)

Reference Designation	HP Part Number	C D	Qty	Description	Mfr Code	Mfr Part Number
A2	05335-60002	8	1	BOARD ASSEMBLY-AMP SUPP	28480	05335-60002
A2C1	0160-4557	0	4	CAPACITOR-FXD .1UF +-20% 50VDC CER	16299	CAC04X7R104M050A
A2C2	0160-4557	0		CAPACITOR-FXD .1UF +-20% 50VDC CER	16299	CAC04X7R104M050A
A2C3	0160-4557	0		CAPACITOR-FXD .1UF +-20% 50VDC CER	16299	CAC04X7R104M050A
A2C4	0160-4557	0		CAPACITOR-FXD .1UF +-20% 50VDC CER	16299	CAC04X7R104M050A
A2C5	0160-3879	7	6	CAPACITOR-FXD .01UF +-20% 100VDC CER	28480	0160-3879
A2C6	0160-4554	7	6	CAPACITOR-FXD .01UF +-20% 50VDC CER	28480	0160-4554
A2C7	0160-0127	2	2	CAPACITOR-FXD 1UF +-20% 25VDC CER	28480	0160-0127
A2C8	0160-4554	7		CAPACITOR-FXD .01UF +-20% 50VDC CER	28480	0160-4554
A2C9	0160-0127	2		CAPACITOR-FXD 1UF +-20% 25VDC CER	28480	0160-0127
A2C10	0160-3879	7		CAPACITOR-FXD .01UF +-20% 100VDC CER	28480	0160-3879
A2C11	0160-3879	7		CAPACITOR-FXD .01UF +-20% 100VDC CER	28480	0160-3879
A2C12	0160-3879	7		CAPACITOR-FXD .01UF +-20% 100VDC CER	28480	0160-3879
A2C13	0160-3879	7		CAPACITOR-FXD .01UF +-20% 100VDC CER	28480	0160-3879
A2C14	0160-2219	7	1	CAPACITOR-FXD 1100PF +-5% 300VDC MICA	28480	0160-2219
A2C15	0140-0210	2	1	CAPACITOR-FXD 270PF +-5% 300VDC MICA	72136	DM15F271J0300WV1CR
A2C16	0160-4554	7		CAPACITOR-FXD .01UF +-20% 50VDC CER	28480	0160-4554
A2C17	0160-4554	7		CAPACITOR-FXD .01UF +-20% 50VDC CER	28480	0160-4554
A2C18	0160-3879	7		CAPACITOR-FXD .01UF +-20% 100VDC CER	28480	0160-3879
A2C19	0160-4554	7		CAPACITOR-FXD .01UF +-20% 50VDC CER	28480	0160-4554
A2C20	0160-4554	7		CAPACITOR-FXD .01UF +-20% 50VDC CER	28480	0160-4554
A2CR1	1901-0376	6	2	DIODE-GEN PRP 35V 50MA DO-35	28480	1901-0376
A2CR2	1901-0376	6		DIODE-GEN PRP 35V 50MA DO-35	28480	1901-0376
A2CR3	1901-0050	3	5	DIODE-SWITCHING 80V 200MA 2NS DO-35	28480	1901-0050
A2CR4	1902-3097	6	1	DIODE-ZNR 5.23V 2% DO-35 PD=.4W	28480	1902-3097
A2CR5	1901-0050	3		DIODE-SWITCHING 80V 200MA 2NS DO-35	28480	1901-0050
A2CR6	1901-0050	3		DIODE-SWITCHING 80V 200MA 2NS DO-35	28480	1901-0050
A2CR7	1901-0050	3		DIODE-SWITCHING 80V 200MA 2NS DO-35	28480	1901-0050
A2CR8	1901-0050	3		DIODE-SWITCHING 80V 200MA 2NS DO-35	28480	1901-0050
A2J1	1200-0618	3	2	SOCKET-IC 18-CONT DIP-SLDR	28480	1200-0618
A2J2	1200-0618	3		SOCKET-IC 18-CONT DIP-SLDR	28480	1200-0618
A2J3	1250-0835	1	2	CONNECTOR-RF SMC M PC 50-OHM	28480	1250-0835
A2J4	1250-0835	1		CONNECTOR-RF SMC M PC 50-OHM	28480	1250-0835
A2L1	9100-1788	6	4	CHOKE-WIDE BAND ZMAX=680 OHM@ 180 MHZ	02114	VK200 20/48
A2L2	9100-1788	6		CHOKE-WIDE BAND ZMAX=680 OHM@ 180 MHZ	02114	VK200 20/48
A2L3	9100-1788	6		CHOKE-WIDE BAND ZMAX=680 OHM@ 180 MHZ	02114	VK200 20/48
A2L4	9100-1788	6		CHOKE-WIDE BAND ZMAX=680 OHM@ 180 MHZ	02114	VK200 20/48
A2Q1	1854-0246	8	1	TRANSISTOR NPN SI PD=350MH FT=250MHZ	04713	8PS 233
A2R1	0757-0280	3	7	RESISTOR 1K 1% .125W F TC=0+-100	24546	C4=1/8-T0=1001-F
A2R2	0757-0280	3		RESISTOR 1K 1% .125W F TC=0+-100	24546	C4=1/8-T0=1001-F
A2R3	0757-0443	0	4	RESISTOR 11K 1% .125W F TC=0+-100	24546	C4=1/8-T0=1102-F
A2R4	0698-6943	1	4	RESISTOR 20K .1% .125W F TC=0+-50	28480	0698-6943
A2R5	0698-6943	1		RESISTOR 20K .1% .125W F TC=0+-50	28480	0698-6943
A2R6	0757-0447	4	4	RESISTOR 16.2K 1% .125W F TC=0+-100	24546	C4=1/8-T0=1622-F
A2R7	0698-6943	1		RESISTOR 20K .1% .125W F TC=0+-50	28480	0698-6943
A2R8	0757-0443	0		RESISTOR 11K 1% .125W F TC=0+-100	24546	C4=1/8-T0=1102-F
A2R9	0757-0443	0		RESISTOR 11K 1% .125W F TC=0+-100	24546	C4=1/8-T0=1102-F
A2R10	0757-0442	9	4	RESISTOR 10K 1% .125W F TC=0+-100	24546	C4=1/8-T0=1002-F
A2R11	0757-0447	4		RESISTOR 16.2K 1% .125W F TC=0+-100	24546	C4=1/8-T0=1622-F
A2R12	0698-4008	5	8	RESISTOR 40K 1% .125W F TC=0+-100	24546	C4=1/8-T0=4002-F
A2R13	0698-4008	5		RESISTOR 40K 1% .125W F TC=0+-100	24546	C4=1/8-T0=4002-F
A2R14	0757-0447	4		RESISTOR 16.2K 1% .125W F TC=0+-100	24546	C4=1/8-T0=1622-F
A2R15	0757-0416	7	1	RESISTOR 511 1% .125W F TC=0+-100	24546	C4=1/8-T0=511K-F
A2R16	0698-6943	1		RESISTOR 20K .1% .125W F TC=0+-50	28480	0698-6943
A2R17	0698-4008	5		RESISTOR 40K 1% .125W F TC=0+-100	24546	C4=1/8-T0=4002-F
A2R18	0698-4008	5		RESISTOR 40K 1% .125W F TC=0+-100	24546	C4=1/8-T0=4002-F
A2R19	0698-4008	5		RESISTOR 40K 1% .125W F TC=0+-100	24546	C4=1/8-T0=4002-F
A2R20	0698-4008	5		RESISTOR 40K 1% .125W F TC=0+-100	24546	C4=1/8-T0=4002-F
A2R21	0757-0442	9		RESISTOR 10K 1% .125W F TC=0+-100	24546	C4=1/8-T0=1002-F
A2R22	0757-0447	4		RESISTOR 16.2K 1% .125W F TC=0+-100	24546	C4=1/8-T0=1622-F
A2R23	0698-6369	5	2	RESISTOR 1M .1% .25W F TC=0+-25	28480	0698-6369
A2R24	0757-0280	3		RESISTOR 1K 1% .125W F TC=0+-100	24546	C4=1/8-T0=1001-F
A2R25	0698-7203	8	2	RESISTOR 42.2 1% .05W F TC=0+-100	24546	C3=1/8-T0=42R2-G
A2R26	0698-7212	9	2	RESISTOR 100 1% .05W F TC=0+-100	24546	C3=1/8-T0=100R-G
A2R27	0698-7222	1	4	RESISTOR 261 1% .05W F TC=0+-100	24546	C3=1/8-T0=261K-G
A2R28	0698-7226	5	2	RESISTOR 383 1% .05W F TC=0+-100	24546	C3=1/8-T0=383K-G
A2R29	0757-0443	0		RESISTOR 11K 1% .125W F TC=0+-100	24546	C4=1/8-T0=1102-F
A2R30	0698-4008	5		RESISTOR 40K 1% .125W F TC=0+-100	24546	C4=1/8-T0=4002-F

See introduction to this section for ordering information
*Indicates factory selected value

Table 6-2. Replaceable Parts (Continued)

Reference Designation	HP Part Number	C D	Qty	Description	Mfr Code	Mfr Part Number
A2R31	0698-4008	5		RESISTOR 40K 1% .125W F TC=0+-100	24546	C4-1/8-T0-4002-F
A2R32	0698-7242	5	2	RESISTOR 1.78K 1% .05W F TC=0+-100	24546	C3-1/8-T0-1781-G
A2R33	0757-0399	5	3	RESISTOR 82.5 1% .125W F TC=0+-100	24546	C4-1/8-T0-82R5-F
A2R34	0757-0442	9		RESISTOR 10K 1% .125W F TC=0+-100	24546	C4-1/8-T0-1002-F
A2R35	0698-7203	8		RESISTOR 42.2 1% .05W F TC=0+-100	24546	C3-1/8-T0-42R2-G
A2R36	0698-7212	9		RESISTOR 100 1% .05W F TC=0+-100	24546	C3-1/8-T0-100R-G
A2R37	0698-7222	1		RESISTOR 261 1% .05W F TC=0+-100	24546	C3-1/8-T0-261R-G
A2R38	0698-7226	5		RESISTOR 383 1% .05W F TC=0+-100	24546	C3-1/8-T0-383R-G
A2R39	0757-0399	9		RESISTOR 82.5 1% .125W F TC=0+-100	24546	C4-1/8-T0-82R5-F
A2R40	1810-0364	5	1	NETWORK-RES 6-SIP470.0 OHM X 5	01121	206A471
A2R41	0757-0442	9		RESISTOR 10K 1% .125W F TC=0+-100	24546	C4-1/8-T0-1002-F
A2R42	0698-3437	2	2	RESISTOR 133 1% .125W F TC=0+-100	24546	C4-1/8-T0-133R-F
A2R43	0757-0399	5		RESISTOR 82.5 1% .125W F TC=0+-100	24546	C4-1/8-T0-82R5-F
A2R44	0757-0465	6	2	RESISTOR 100K 1% .125W F TC=0+-100	24546	C4-1/8-T0-1003-F
A2R45	0698-8094	7	1	RESISTOR 1.82M 1% .5W F TC=0+-100	28480	0698-8094
A2R46	0698-6369	5		RESISTOR 1M 1% .25W F TC=0+-25	28480	0698-6369
A2R47	0698-0398	4	2	RESISTOR 75 1% .125W F TC=0+-100	24546	C4-1/8-T0-75R0-F
A2R48	0757-1108	6	2	RESISTOR 300 1% .125W F TC=0+-100	24546	C4-1/8-T0-301-F
A2R49	0757-1108	6		RESISTOR 300 1% .125W F TC=0+-100	24546	C4-1/8-T0-301-F
A2R50	0757-0398	4		RESISTOR 75 1% .125W F TC=0+-100	24546	C4-1/8-T0-75R0-F
A2R51	0698-7242	5		RESISTOR 1.78K 1% .05W F TC=0+-100	24546	C3-1/8-T0-1781-G
A2R52	0698-6612	1	1	RESISTOR 2K 1% .125W F TC=0+-50	28480	0698-6612
A2R53	0698-3491	8	1	RESISTOR 1K 1% .125W F TC=0+-50	28480	0698-3491
A2R54	0757-0280	3		RESISTOR 1K 1% .125W F TC=0+-100	24546	C4-1/8-T0-1001-F
A2R55	0698-7222	1		RESISTOR 261 1% .05W F TC=0+-100	24546	C3-1/8-T0-261R-G
A2R56	0698-7222	1		RESISTOR 261 1% .05W F TC=0+-100	24546	C3-1/8-T0-261R-G
A2R57	0757-0428	1	1	RESISTOR 1.62K 1% .125W F TC=0+-100	24546	C4-1/8-T0-1621-F
A2R58	0757-0280	3		RESISTOR 1K 1% .125W F TC=0+-100	24546	C4-1/8-T0-1001-F
A2R59	0698-3437	2		RESISTOR 133 1% .125W F TC=0+-100	24546	C4-1/8-T0-133R-F
A2R60	0757-0465	6		RESISTOR 100K 1% .125W F TC=0+-100	24546	C4-1/8-T0-1003-F
A2R61	1810-0280	8	1	NETWORK-RES 10-SIP10.0K OHM X 9	01121	210A103
A2R62	0757-0280	3		RESISTOR 1K 1% .125W F TC=0+-100	24546	C4-1/8-T0-1001-F
A2R63	0757-0280	3		RESISTOR 1K 1% .125W F TC=0+-100	24546	C4-1/8-T0-1001-F
A2R64	0757-0317	7	1	RESISTOR 1.33K 1% .125W F TC=0+-100	24546	C4-1/8-T0-1331-F
A2R65	2100-3383	4	2	RESISTOR-TRMR 50 10% C TOP-ADJ 1-TRN	28480	2100-3383
A2R66	2100-3383	4		RESISTOR-TRMR 50 10% C TOP-ADJ 1-TRN	28480	2100-3383
A2U1	1826-0315	3	3	IC OP AMP GP QUAD 14-DIP-P	27014	LM348N
A2U2	1826-0609	8	3	IC MULTIPLXR ANLG 16-DIP-C	06665	MUX08F0
A2U3	1826-0315	3		IC OP AMP GP QUAD 14-DIP-P	27014	LM348N
A2U4	1826-0609	8		IC MULTIPLXR ANLG 16-DIP-C	06665	MUX08F0
A2U5	1826-0610	1	1	IC MULTIPLXR 4-CHAN=ANLG DUAL 16-DIP-C	06665	MUX24F0
A2U6	1858-0040	8	1	TRANSISTOR ARRAY 16-PIN PLSTC DIP	01928	CA3127E
A2U7	1820-1359	5	1	IC MUXR/DATA-SEL ECL 4-T0-1-LINE DUAL	04713	MC10174P
A2U8	1820-1173	1	1	IC XLTR ECL TTL TO=ECL QUAD 2-INP	04713	MC10124L
A2U9	1826-0575	7	1	IC CONV V/FREQ 14-DIP-P	15818	9400CJ
A2U10	1826-0609	8		IC MULTIPLXR ANLG 16-DIP-C	06665	MUX08F0
A2U11	1820-0794	0	1	IC FF ECL D-M/S	04713	MC1670L
A2U12	1820-1196	8	2	IC FF TTL LS D-TYPE POS-EDGE-TRIG COM	01295	SN74LS174N
A2U13	1826-0315	3		IC OP AMP GP QUAD 14-DIP-P	27014	LM348N
A2U14	1820-1240	3	1	IC DCCR TTL S 3-T0=8-LINE 3-INP	01295	SN748138N
A2U15	1820-1196	8		IC FF TTL LS D-TYPE POS-EDGE-TRIG COM	01295	SN74LS174N
A2U16	1820-1917	1	1	IC 8FR TTL LS LINE DRVR OCTL	01295	SN74LS240N
A2XA8	1251-0472	4	2	CONNECTOR-PC EDGE 6-CONT/ROW 2-ROWS	28480	1251-0472
A2XA9	1251-0472	4		CONNECTOR-PC EDGE 6-CONT/ROW 2-ROWS	28480	1251-0472

See introduction to this section for ordering information
*Indicates factory selected value

Table 6-2. Replaceable Parts (Continued)

Reference Designation	HP Part Number	C D	Qty	Description	Mfr Code	Mfr Part Number
A3	05335-60003	9	1	BOARD ASSEMBLY-AMP BUFFER	28480	05335-60003
A3C1	0160-3877	5	4	CAPACITOR-FXD 100PF +-20% 200VDC CER	28480	0160-3877
A3C2	0180-2814	0	4	CAPACITOR-FXD 22UF +-20% 10VDC TA	28480	0180-2814
A3C3	0180-2821	9	4	CAPACITOR-FXD 22UF +-20% 35VDC TA	28480	0180-2821
A3C4†	0160-4931	4	8	CAPACITOR-MATCHED SET OF 2	28480	0160-4931
A3C5†	0160-4931	4	4	CAPACITOR-MATCHED SET OF 2	28480	0160-4931
A3C6	0180-2814	0		CAPACITOR-FXD 22UF +-20% 10VDC TA	28480	0180-2814
A3CR7†	0160-4931	4		CAPACITOR-MATCHED SET OF 2	28480	0160-4931
A3C8†	0160-4931	4		CAPACITOR-MATCHED SET OF 2	28480	0160-4931
A3C9	0160-3879	7	28	CAPACITOR-FXD .01UF +-20% 100VDC CER	28480	0160-3879
A3C10	0160-3879	7		CAPACITOR-FXD .01UF +-20% 100VDC CER	28480	0160-3879
A3C11	0160-3879	7		CAPACITOR-FXD .01UF +-20% 100VDC CER	28480	0160-3879
A3C12	0160-3879	7		CAPACITOR-FXD .01UF +-20% 100VDC CER	28480	0160-3879
A3C13	0160-3879	7		CAPACITOR-FXD .01UF +-20% 100VDC CER	28480	0160-3879
A3C14	0160-3879	7		CAPACITOR-FXD .01UF +-20% 100VDC CER	28480	0160-3879
A3C15	0160-3877	5		CAPACITOR-FXD 100PF +-20% 200VDC CER	28480	0160-3877
A3C16	0160-3879	7		CAPACITOR-FXD .01UF +-20% 100VDC CER	28480	0160-3879
A3C17	0160-3879	7		CAPACITOR-FXD .01UF +-20% 100VDC CER	28480	0160-3879
A3C18	0160-3879	7		CAPACITOR-FXD .01UF +-20% 100VDC CER	28480	0160-3879
A3C18	0160-4705	0	2	CAPACITOR-FXD 2.2PF +-5% 500VDC CER	28480	0160-4705
A3C19	0160-3879	7		CAPACITOR-FXD .01UF +-20% 100VDC CER	28480	0160-3879
A3C20	0160-3879	7		CAPACITOR-FXD .01UF +-20% 100VDC CER	28480	0160-3879
A3C21	0160-4424	0	2	CAPACITOR-FXD .047UF +-20% 500VDC CER	51642	400-500-X7R-473M
A3C22	0160-4705	0		CAPACITOR-FXD 2.2PF +-5% 500VDC CER	28480	0160-4705
A3C23*	0160-3875	3	2	CAPACITOR-FXD 22PF +-5% 200VDC CER 0+-30	51642	
A3C24	0160-4703	8	2	CAPACITOR-FXD 68PF +-5% 500VDC CER 0+-30	28480	0160-4703
A3C25	0160-3879	7		CAPACITOR-FXD .01UF +-20% 100VDC CER	28480	0160-3879
A3C26	0160-3879	7		CAPACITOR-FXD .01UF +-20% 100VDC CER	28480	0160-3879
A3C27*	0160-3878	6	2	CAPACITOR-FXD 1000PF +-20% 100VDC CER	28480	0160-3878
A3C28	0180-2821	9		CAPACITOR-FXD 22UF+-20% 35VDC TA	28480	0180-2821
A3C29	0160-3879	7		CAPACITOR-FXD .01UF +-20% 100VDC CER	28480	0160-3879
A3C30	0180-2821	9		CAPACITOR-FXD 22UF+-20% 35VDC TA	28480	0180-2821
A3C31	0160-3879	7		CAPACITOR-FXD .01UF +-20% 100VDC CER	28480	0160-3879
A3C32	0160-3879	7		CAPACITOR-FXD .01UF +-20% 100VDC CER	28480	0160-3879
A3C33	0160-3879	7		CAPACITOR-FXD .01UF +-20% 100VDC CER	28480	0160-3879
A3C34	0160-4703	8		CAPACITOR-FXD 68PF +-5% 500VDC CER 0+-30	28480	0160-4703
A3C35	0160-3878	6		CAPACITOR-FXD 1000PF +-20% 100VDC CER	28480	0160-3878
A3C36	0160-3879	7		CAPACITOR-FXD .01UF +-20% 100VDC CER	28480	0160-3879
A3C37	0160-3875	3		CAPACITOR-FXD 22PF +-5% 200VDC CER 0+-30	51642	
A3C39	0160-4424	0		CAPACITOR-FXD .047UF +-20% 500VDC CER	51642	400-500-X7R-473M
A3C40	0180-2814	0		CAPACITOR-FXD 22UF +-20% 10VDC TA	28480	0180-2814
A3C41	0160-3879	7		CAPACITOR-FXD .01UF +-20% 100VDC CER	28480	0160-3879
A3C42	0160-3879	7		CAPACITOR-FXD .01UF +-20% 100VDC CER	28480	0160-3879
A3C43	0160-3879	7		CAPACITOR-FXD .01UF +-20% 100VDC CER	28480	0160-3879
A3C44	0160-3879	7		CAPACITOR-FXD .01UF +-20% 100VDC CER	28480	0160-3879
A3C45	0160-3879	7		CAPACITOR-FXD .01UF +-20% 100VDC CER	28480	0160-3879
A3C46	0160-3879	7		CAPACITOR-FXD .01UF +-20% 100VDC CER	28480	0160-3879
A3C47	0160-3879	7		CAPACITOR-FXD .01UF +-20% 100VDC CER	28480	0160-3879
A3C48	0160-3879	7		CAPACITOR-FXD .01UF +-20% 100VDC CER	28480	0160-3879
A3C49	0160-3879	7		CAPACITOR-FXD .01UF +-20% 100VDC CER	28480	0160-3879
A3C50	0160-3879	7		CAPACITOR-FXD .01UF +-20% 100VDC CER	28480	0160-3879
A3C51, A3C52†	0160-4931	4		CAPACITOR-MATCHED SET OF 2 (SEE PARA. 6-15)	28480	0160-4931
A3C53, A3C57†	0160-4931	4		CAPACITOR-MATCHED SET OF 2 (SEE PARA. 6-15)	28480	0160-4931
A3C54	0180-2821	4		CAPACITOR-FXD 22UF +-20% 35VDC TA	28480	0180-2821
A3C55	0160-3877	9		CAPACITOR-FXD 100PF +-20% 200VDC CER	28480	0160-3877
A3C56	0180-2814	5		CAPACITOR-FXD 22UF +-20 10VDC TA	28480	0180-2814
A3C58	0180-3877	0		CAPACITOR-FXD 100PF +-20% 200VDC CER	28480	0180-3877
A3CR1, A3CR2†	05335-80003	4		DIODE-MATCHED SET OF 4 (REFER TO PARA. 6-15)	28480	05335-80003
A3CR3	1901-1080	5		DIODE-SCHOTTKY 1N5817 20V 1A	28480	1901-1080
A3CR4, A3CR5†	05335-80003	0		DIODE-MATCHED SET OF 4 (REFER TO PARA. 6-15)	28480	05335-80003
A3CR6, A3CR7†	05335-80003	0	12	DIODE-MATCHED SET OF 4 (REFER TO PARA. 6-15)	28480	05335-80003
A3CR8, A3CR9†	05335-80003	0		DIODE-MATCHED SET OF 4 (REFER TO PARA. 6-15)	28480	05335-80003
A3CR10, A3CR11†	05335-80003	1	2	DIODE-MATCHED SET OF 4 (REFER TO PARA. 6-15)	28480	05335-80003
A3CR12	1902-0041	0		DIODE-ZNR 5.11V 5% DO-35 PD=.4W	28480	1902-0041
A3CR13	1902-0057	0		DIODE-ZNR 6.499V 5% DO-35 PD=.4W	28480	1902-0057
A3CR14	1902-0050	0		DIODE-SWITCHING 80V 200MA 2NS DO-35	28480	1902-0050
A3CR15	1902-3136	0	4	DIODE-ZNR 8.06V 5% DP-35 PD=.4W	28480	1902-3136
A3CR16	1902-3136	4	2	DIODE-ZNR 8.06V 5% DO-35 PD=.4W	28480	1902-3136
A3CR17	1901-1080	3	1	DIODE-SCHOTTKY 1N5817 20V 1A	28480	1901-1080
A3CR18	1902-0057	0		DIODE-ZNR 6.499V 5% DO-35 PD=.4W	28480	1902-0057
A3CR19	1902-0041	4	2	DIODE-ZNR 5.11V 5% DO-35 PD=.4W	28480	1902-0041
A3CR20, A3CR21†	05335-80003	4		DIODE-MATCHED SET OF 4 (REFER TO PARA. 6-15)	28480	05335-80003
A3CR22, A3CR23†	05335-80003	1		DIODE-MATCHED SET OF 4 (REFER TO PARA. 6-15)	28480	05335-80003
		2				

See introduction to this section for ordering information
 *Indicates factory selected value
 †Matched sets of components. See paragraph 6-15.

Table 6-2. Replaceable Parts (Continued)

Reference Designation	HP Part Number	C D	Qty	Description	Mfr Code	Mfr Part Number
A3CR24†	05335-80003	0		DIODE-MATCHED SET OF 4	28480	05335-80003
A3CR25†	05335-80003	0		DIODE-MATCHED SET OF 4	28480	05335-80003
A3CR26†	05335-80003	0		DIODE-MATCHED SET OF 4	28480	05335-80003
A3CR27†	05335-80003	0		DIODE-MATCHED SET OF 4	28480	05335-80003
A3CR28†	05335-80003	0		DIODE-MATCHED SET OF 4	28480	05335-80003
A3CR29†	05335-80003	0		DIODE-MATCHED SET OF 4	28480	05335-80003
A3D8†	1990-0487	7	2	LED-VISIBLE LUM-INTRIMCD IF#20MA-MAX	28480	5082-4584
A3D82	1990-0487	7		LED-VISIBLE LUM-INTRIMCD IF#20MA-MAX	28480	5082-4584
A3J1	1250-0835	1	2	CONNECTOR=RF BNC M PC 50-OHM	28480	1250-0835
A3J2	1200-0618	3	2	SOCKET-IC 18-CONT DIP-SLDR	28480	1200-0618
A3J3	1250-1671	5	2	CONNECTOR=RF BNC FEM 8GL-HOLE-RR 50-OHM	28480	1250-1671
A3J4	1250-1671	5		CONNECTOR=RF BNC FEM 8GL-HOLE-RR 50-OHM	28480	1250-1671
A3J5	1200-0618	3		SOCKET-IC 18-CONT DIP-SLDR	28480	1200-0618
A3J6	1250-0835	1		CONNECTOR=RF BNC M PC 50-OHM	28480	1250-0835
A3K1	0490-0508	2	1	RELAY 2C 12VDC-COIL .5A 28VDC	28480	0490-0508
A3L1	05335-80001	9	2	INDUCTOR	28480	05335-80001
A3L2	05335-80001	9		INDUCTOR	28480	05335-80001
A3O1	1854-0686	0	2	TRANSISTOR NPN SI TO-72 PD=200MW FT=4GHZ	28480	1854-0686
A3O2	1854-0636	0	4	TRANSISTOR NPN SI TO-92 PD=350MW	28480	1854-0636
A3O3	1854-0636	0		TRANSISTOR NPN SI TO-92 PD=350MW	28480	1854-0636
A3O4	1855-0300	7	2	TRANSISTOR J-FET N-CHAN D=MODE TO-106	28480	1855-0300
A3O5	1855-0300	7		TRANSISTOR J-FET N-CHAN D=MODE TO-106	28480	1855-0300
A3O6	1854-0636	0		TRANSISTOR NPN SI TO-92 PD=350MW	28480	1854-0636
A3O7	1854-0636	0		TRANSISTOR NPN SI TO-92 PD=350MW	28480	1854-0636
A3O8	1854-0686	0		TRANSISTOR NPN SI TO-72 PD=200MW FT=4GHZ	28480	1854-0686
A3R1	0699-0071	6	8	RESISTOR 4.64M 1% .125W F TC#0+-100	28480	0699-0071
A3R2	0699-0071	6		RESISTOR 4.64M 1% .125W F TC#0+-100	28480	0699-0071
A3R3	0698-7267	4	8	RESISTOR 19.6K 1% .05W F TC#0+-100	24546	C3=1/8-T0=1962-G
A3R4	0698-7267	4		RESISTOR 19.6K 1% .05W F TC#0+-100	24546	C3=1/8-T0=1962-G
A3R5	0698-7227	6	6	RESISTOR 422 1% .05W F TC#0+-100	24546	C3=1/8-T0=422R-G
A3R6	0698-7212	9	6	RESISTOR 100 1% .05W F TC#0+-100	24546	C3=1/8-T0=100M-G
A3R7*	0698-7288	9	4	RESISTOR 147K 1% .05W F TC#0+-100	24546	C3=1/8-T0=147J-G
A3R8*	0698-7288	9		RESISTOR 147K 1% .05W F TC#0+-100	24546	C3=1/8-T0=147J-G
A3R9	0698-7212	9		RESISTOR 100 1% .05W F TC#0+-100	24546	C3=1/8-T0=100R-G
A3R10	0699-0071	6		RESISTOR 4.64M 1% .125W F TC#0+-100	28480	0699-0071
A3R11	0699-0071	6		RESISTOR 4.64M 1% .125W F TC#0+-100	28480	0699-0071
A3R12	0698-7267	4	2	RESISTOR 19.6K 1% .05W F TC#0+-100	24546	C3=1/8-T0=1962-G
A3R13	0698-7267	4		RESISTOR 19.6K 1% .05W F TC#0+-100	24546	C3=1/8-T0=1962-G
A3R14	0698-7218	5	2	RESISTOR 178 1% .05W F TC#0+-100	24546	C3=1/8-T0=178M-G
A3R15	0698-7249	2	4	RESISTOR 3.48K 1% .05W F TC#0+-100	24546	C3=1/8-T0=348J-G
A3R16	0698-3444	1	2	RESISTOR 316 1% .125W F TC#0+-100	24546	C4=1/8-T0=316R-F
A3R17	0698-7205	0	6	RESISTOR 51.1 1% .05W F TC#0+-100	24546	C3=1/8-T0=511R-G
A3R18	0698-7249	2		RESISTOR 3.48K 1% .05W F TC#0+-100	24546	C3=1/8-T0=348J-G
A3R19	0698-6433	4	4	RESISTOR 100 1% .25W F TC#0+-100	28480	0698-6433
A3R20	0698-6433	4		RESISTOR 100 1% .25W F TC#0+-100	28480	0698-6433
A3R21	0698-7212	9		RESISTOR 100 1% .05W F TC#0+-100	24546	C3=1/8-T0=100M-G
A3R22	2100-3802	2	2	RESISTOR-VAR W/SW 10K 20% LIN SPST-NO	28480	2100-3802
A3R23	0698-7188	8	2	RESISTOR 10 1% .05W F TC#0+-100	24546	C3=1/8-T0=10M-G
A3R24	0698-7198	0	6	RESISTOR 26.1 1% .05W F TC#0+-100	24546	C3=1/8-T0=261R-G
A3R25	0698-7198	0		RESISTOR 26.1 1% .05W F TC#0+-100	24546	C3=1/8-T0=261R-G
A3R26	0698-7222	1	2	RESISTOR 261 1% .05W F TC#0+-100	24546	C3=1/8-T0=261R-G
A3R27	0699-0073	8	2	RESISTOR 10M 1% .125W F TC#0+-100	28480	0699-0073
A3R28	0698-7205	0		RESISTOR 51.1 1% .05W F TC#0+-100	24546	C3=1/8-T0=511M-G
A3R29*	0698-7247	0	2	RESISTOR 2.87K 1% .05W F TC#0+-100	24546	C3=1/8-T0=287J-G
A3R30	0698-3922	0	4	RESISTOR 487K 1% .125W F TC#0+-50	28480	0698-3922
A3R31	0698-7227	6		RESISTOR 422 1% .05W F TC#0+-100	24546	C3=1/8-T0=422M-G
A3R32	0698-6400	5	2	RESISTOR 900K 1% .25W F TC#0+-100	19701	MF52C1/4-T0=900J-F
A3R33	0757-0416	7	2	RESISTOR 511 1% .125W F TC#0+-100	24546	C4=1/8-T0=511M-F
A3R34	0698-7205	0		RESISTOR 51.1 1% .05W F TC#0+-100	24546	C3=1/8-T0=511R-G
A3R35	0698-7216	3	2	RESISTOR 147 1% .05W F TC#0+-100	24546	C3=1/8-T0=147R-G
A3R36	0698-7252	7	2	RESISTOR 4.64K 1% .05W F TC#0+-100	24546	C3=1/8-T0=464J-G
A3R37	2100-1738	9	2	RESISTOR-TRMR 10K 10% C TOP=ADJ 1-TRN	73138	82PR10K
A3R38	0698-7227	6		RESISTOR 422 1% .05W F TC#0+-100	24546	C3=1/8-T0=422M-G
A3R39	0698-7245	8	2	RESISTOR 2.37K 1% .05W F TC#0+-100	24546	C3=1/8-T0=237J-G
A3R40	0698-7238	9	4	RESISTOR 1.21K 1% .05W F TC#0+-100	24546	C3=1/8-T0=121J-G
A3R41	0698-7198	0		RESISTOR 26.1 1% .05W F TC#0+-100	24546	C3=1/8-T0=261R-G
A3R42	0698-6430	1	2	RESISTOR 111K 5% .125W F TC#0+-100	28480	0698-6430
A3R43	0698-3905	9	4	RESISTOR 513K 1% .125W F TC#0+-50	28480	0698-3905
A3R44	0698-7241	4	2	RESISTOR 1.62K 1% .05W F TC#0+-100	28480	0698-7241
A3R45	0698-3905	9		RESISTOR 513K 1% .125W F TC#0+-50	28480	0698-3905
A3R46	0698-3922	0		RESISTOR 487K 1% .125W F TC#0+-50	28480	0698-3922
A3R47	2100-2497	9	2	RESISTOR-TRMR 2K 10% C TOP=ADJ 1-TRN	73138	82PR2K
A3R48	0698-7238	9		RESISTOR 1.21K 1% .05W F TC#0+-100	24546	C3=1/8-T0=121J-G
A3R49	0698-7245	8		RESISTOR 2.37K 1% .05W F TC#0+-100	24546	C3=1/8-T0=237J-G
A3R50	0698-3905	9		RESISTOR 513K 1% .125W F TC#0+-50	28480	0698-3905

See introduction to this section for ordering information
*Indicates factory selected value

†Matched sets of components. See paragraph 6-15.

Table 6-2. Replaceable Parts (Continued)

Reference Designation	HP Part Number	C D	Qty	Description	Mfr Code	Mfr Part Number
A3R51	0698-6430	1		RESISTOR 111K .5% .125W F TC0+100	28480	0698-6430
A3R52	0698-723F	9		RESISTOR 1.21K 1% .05W F TC0+100	24546	C3-1/8-T0-1211-G
A3R53	0698-7198	0		RESISTOR 26.1 1% .05W F TC0+100	24546	C3-1/8-T00-26R1-G
A3R54	0698-7227	6		RESISTOR 422 1% .05W F TC0+100	24546	C3-1/8-T0-422R-G
A3R55	0698-7216	3		RESISTOR 147 1% .05W F TC0+100	24546	C3-1/8-T0-147R-G
A3R56	0698-3905	9		RESISTOR 513K .1% .125W F TC0+50	28480	0698-3905
A3R57	0698-723F	9		RESISTOR 1.21K 1% .05W F TC0+100	24546	C3-1/8-T0-1211-G
A3R58	0757-0416	7		RESISTOR 511 1% .125W F TC0+100	24546	C4-1/8-T0-511R-F
A3R59	0698-7222	1		RESISTOR 261 1% .05W F TC0+100	24546	C3-1/8-T0-261R-G
A3R60	0699-0073	8		RESISTOR 10M 1% .125W F TC0+100	28480	0699-0073
A3R61	0698-6400	5		RESISTOR 900K 1% .25W F TC0+100	19701	MF52C1/4-T0-9003-F
A3R62	0698-3922	0		RESISTOR 487K .1% .125W F TC0+50	28480	0698-3922
A3R63	0698-3922	0		RESISTOR 487K .1% .125W F TC0+50	28480	0698-3922
A3R64	0698-7227	6		RESISTOR 422 1% .05W F TC0+100	24546	C3-1/8-T0-422R-G
A3R65	0698-7212	9		RESISTOR 100 1% .05W F TC0+100	24546	C3-1/8-T0-100R-G
A3R66	2100-3802	2		RESISTOR-VAR W/SH 10K 20X LIN SPST-NO	28480	2100-3802
A3R67	0698-7188	8		RESISTOR 10 1% .05W F TC0+100	24546	C3-1/8-T00-10R-G
A3R68	0698-7218	5		RESISTOR 178 1% .05W F TC0+100	24546	C3-1/8-T0-178R-G
A3R69	0698-6433	4		RESISTOR 100 1% .25W F TC0+100	28480	0698-6433
A3R70	0698-6433	4		RESISTOR 100 1% .25W F TC0+100	28480	0698-6433
A3R71	0698-7205	0		RESISTOR 51.1 1% .05W F TC0+100	24546	C3-1/8-T00-51R1-G
A3R72	0698-7227	6		RESISTOR 422 1% .05W F TC0+100	24546	C3-1/8-T0-422R-G
A3R73	0698-7249	2		RESISTOR 3.48K 1% .05W F TC0+100	24546	C3-1/8-T0-3481-G
A3R74	0698-3444	1		RESISTOR 318 1% .125W F TC0+100	24546	C4-1/8-T0-318R-F
A3R75	0698-7205	0		RESISTOR 51.1 1% .05W F TC0+100	24546	C3-1/8-T00-51R1-G
A3R76	0698-7249	2		RESISTOR 3.48K 1% .05W F TC0+100	24546	C3-1/8-T0-3481-G
A3R77	0698-7198	0		RESISTOR 26.1 1% .05W F TC0+100	24546	C3-1/8-T00-26R1-G
A3R78	0698-7198	0		RESISTOR 26.1 1% .05W F TC0+100	24546	C3-1/8-T00-26R1-G
A3R79	0698-7212	9		RESISTOR 100 1% .05W F TC0+100	24546	C3-1/8-T0-100R-G
A3R80	0698-7288	9		RESISTOR 147K 1% .05W F TC0+100	24546	C3-1/8-T0-147R-G
A3R81	0698-7288	9		RESISTOR 147K 1% .05W F TC0+100	24546	C3-1/8-T0-147R-G
A3R82	0698-7212	9		RESISTOR 100 1% .05W F TC0+100	24546	C3-1/8-T0-100R-G
A3R83	0698-7247	0		RESISTOR 2.87K 1% .05W F TC0+100	24546	C3-1/8-T0-2871-G
A3R84	0698-7267	4		RESISTOR 19.6K 1% .05W F TC0+100	24546	C3-1/8-T0-1962-G
A3R85	0698-7267	4		RESISTOR 19.6K 1% .05W F TC0+100	24546	C3-1/8-T0-1962-G
A3R86	0698-7205	0		RESISTOR 51.1 1% .05W F TC0+100	24546	C3-1/8-T00-51R1-G
A3R87	0698-7252	7		RESISTOR 4.64K 1% .05W F TC0+100	24546	C3-1/8-T0-4641-G
A3R88	2100-1738	9		RESISTOR-TRMR 10K 10X C TOP-ADJ 1-TRN	73138	82PR10K
A3R89	0699-0071	6		RESISTOR 4.64M 1% .125W F TC0+100	28480	0699-0071
A3R90	0699-0071	6		RESISTOR 4.64M 1% .125W F TC0+100	28480	0699-0071
A3R91	0699-0071	6		RESISTOR 4.64M 1% .125W F TC0+100	28480	0699-0071
A3R92	0699-0071	6		RESISTOR 4.64M 1% .125W F TC0+100	28480	0699-0071
A3R93	0698-7241	4		RESISTOR 1.62K 1% .05W F TC0+100	28480	0698-7241
A3R94	0698-7267	4		RESISTOR 19.6K 1% .05W F TC0+100	24546	C3-1/8-T0-1962-G
A3R95	0698-7267	4		RESISTOR 19.6K 1% .05W F TC0+100	24546	C3-1/8-T0-1962-G
A3R96	2100-2497	9		RESISTOR-TRMR 2K 10X C TOP-ADJ 1-TRN	73138	82PR2K
A3R97	0698-7284	5	2	RESISTOR 100K 1% .05W F TC0+100	24546	C3-1/8-T0-1003-G
A3R98	0698-7284	5		RESISTOR 100K 1% .05W F TC0+100	24546	C3-1/8-T0-1003-G
A3B#2	3101-2124	2	11	SWITCH-PB DPDT ALTNG .25A 115VAC	28480	3101-2124
A3B#2	3101-2124	2		SWITCH-PB DPDT ALTNG .25A 115VAC	28480	3101-2124
A3B#3	3101-2124	2		SWITCH-PB DPDT ALTNG .25A 115VAC	28480	3101-2124
A3B#4	3101-2124	2		SWITCH-PB DPDT ALTNG .25A 115VAC	28480	3101-2124
A3B#5	3101-2124	2		SWITCH-PB DPDT ALTNG .25A 115VAC	28480	3101-2124
A3B#6	3101-2124	2		SWITCH-PB DPDT ALTNG .25A 115VAC	28480	3101-2124
A3B#7	3101-2124	2		SWITCH-PB DPDT ALTNG .25A 115VAC	28480	3101-2124
A3B#8	3101-2124	2		SWITCH-PB DPDT ALTNG .25A 115VAC	28480	3101-2124
A3B#9	3101-2124	2		SWITCH-PB DPDT ALTNG .25A 115VAC	28480	3101-2124
A3B#10	3101-2124	2		SWITCH-PB DPDT ALTNG .25A 115VAC	28480	3101-2124
A3B#12	3101-2124	2		SWITCH-PB DPDT ALTNG .25A 115VAC	28480	3101-2124
A3U1	1826-0600	9	2	IC OP AMP QUAD 14-DIP-P	01295	TL074ACN
A3U2	1826-0570	2	2	IC	28480	1826-0570
A3U3	1826-0035	4	2	IC OP AMP LOW-DRIFT TO-99	27014	LM308AM
A3U4	1826-0035	4		IC OP AMP LOW-DRIFT TO-99	27014	LM308AM
A3U5	1826-0570	2		IC	28480	1826-0570
A3U6	1826-0600	9		IC OP AMP QUAD 14-DIP-P	01295	TL074ACN
				A3 MISCELLANEOUS PARTS		
	0340-0092	2	4	TERMINAL-STUD SPCL-FDTHRU PRESS-MTG	28480	0340-0092
	0360-1682	0	1	TERMINAL-STUD SCL-TUR PRESS-MTG	28480	0360-1682
	1205-0061	0	2	HEAT SINK TO-5/TO-39-C8	28480	1205-0061
	4040-1616	0	2		28480	4040-1616
	5041-0234	5	6		28480	5041-0234
	5041-0300	6	2		28480	5041-0300

See introduction to this section for ordering information
*Indicates factory selected value

Table 6-2. Replaceable Parts (Continued)

Reference Designation	HP Part Number	C D	Qty	Description	Mfr Code	Mfr Part Number
Aa	05335-60004	0	1	BOARD ASSEMBLY-MAIN LOGIC	28480	05335-60004
A4C1	0160-4554	7	17	CAPACITOR-FXD .01UF +/-20% 50VDC CER	28480	0160-4554
A4C2	0140-0234	0	2	CAPACITOR-FXD 500PF +/-1% 300VDC MICA	72136	DM15F501F0300NVIC
A4C3	0140-0234	0		CAPACITOR-FXD 500PF +/-1% 300VDC MICA	72136	DM15F501F0300NV1C
A4C4	0160-0576	5	9	CAPACITOR-FXD .1UF +/-20% 50VDC CER	28480	0160-0576
A4C5	0160-0576	5		CAPACITOR-FXD .1UF +/-20% 50VDC CER	28480	0160-0576
A4C6	0121-0061	1	1	CAPACITOR-V TRMR-CER 5.5-18PF 350V	52763	304322 5.5/18PF NPD
A4C7	0160-0576	5		CAPACITOR-FXD .1UF +/-20% 50VDC CER	28480	0160-0576
A4C8	0160-3879	7	9	CAPACITOR-FXD .01UF +/-20% 100VDC CER	28480	0160-3879
A4C9	0160-0368	3	1	CAPACITOR-FXD 16PF +/-5% 500VDC MICA	28480	0160-0368
A4C10	0160-3879	7		CAPACITOR-FXD .01UF +/-20% 100VDC CER	28480	0160-3879
A4C11	0160-3879	7		CAPACITOR-FXD .01UF +/-20% 100VDC CER	28480	0160-3879
A4C12	0160-4554	7		CAPACITOR-FXD .01UF +/-20% 50VDC CER	28480	0160-4554
A4C13	0160-4554	7		CAPACITOR-FXD .01UF +/-20% 50VDC CER	28480	0160-4554
A4C14	0160-3879	7		CAPACITOR-FXD .01UF +/-20% 100VDC CER	28480	0160-3879
A4C15	0160-3879	7		CAPACITOR-FXD .01UF +/-20% 100VDC CER	28480	0160-3879
A4C16	0160-0576	5		CAPACITOR-FXD .1UF +/-20% 50VDC CER	28480	0160-0576
A4C17	0160-2220	0	2	CAPACITOR-FXD 1200PF +/-5% 300VDC MICA	28480	0160-2220
A4C18	0160-2230	2	1	CAPACITOR-FXD 3300PF +/-5% 300VDC MICA	28480	0160-2230
A4C19	0160-0155	8	3	CAPACITOR-FXD 2.2UF +/-20% 20VDC TA	56289	150D225X0020A2
A4C20	0160-4554	7		CAPACITOR-FXD .01UF +/-20% 50VDC CER	28480	0160-4554
A4C21	0160-4554	7		CAPACITOR-FXD .01UF +/-20% 50VDC CER	28480	0160-4554
A4C22	0160-0576	5		CAPACITOR-FXD .1UF +/-20% 50VDC CER	28480	0160-0576
A4C23	0160-2220	0		CAPACITOR-FXD 1200PF +/-5% 300VDC MICA	28480	0160-2220
A4C24	0160-3879	7		CAPACITOR-FXD .01UF +/-20% 100VDC CER	28480	0160-3879
A4C25	0160-2224	4	1	CAPACITOR-FXD 1800PF +/-5% 300VDC MICA	28480	0160-2224
A4C26	0160-4554	7		CAPACITOR-FXD .01UF +/-20% 50VDC CER	28480	0160-4554
A4C27	0160-4554	7		CAPACITOR-FXD .01UF +/-20% 50VDC CER	28480	0160-4554
A4C28	0160-4554	7		CAPACITOR-FXD .01UF +/-20% 50VDC CER	28480	0160-4554
A4C29	0160-0576	5		CAPACITOR-FXD .1UF +/-20% 50VDC CER	28480	0160-0576
A4C30	0160-0576	5		CAPACITOR-FXD .1UF +/-20% 50VDC CER	28480	0160-0576
A4C31	0160-0576	5		CAPACITOR-FXD .1UF +/-20% 50VDC CER	28480	0160-0576
A4C32	0160-4554	7		CAPACITOR-FXD .01UF +/-20% 50VDC CER	28480	0160-4554
A4C33	0160-3879	7		CAPACITOR-FXD .01UF +/-20% 100VDC CER	28480	0160-3879
A4C34	0160-3879	7		CAPACITOR-FXD .01UF +/-20% 100VDC CER	28480	0160-3879
A4C35	0160-4554	7		CAPACITOR-FXD .01UF +/-20% 50VDC CER	28480	0160-4554
A4C36	0160-2662	6	1	CAPACITOR-FXD 10UF +/-10% 10VDC TA	25088	D4R7G81A10K
A4C37	0160-4554	7		CAPACITOR-FXD .01UF +/-20% 50VDC CER	28480	0160-4554
A4C38	0160-0576	4	1	CAPACITOR-FXD .047UF +/-20% 50VDC CER	28480	0160-0576
A4C39	0160-4554	7		CAPACITOR-FXD .01UF +/-20% 50VDC CER	28480	0160-4554
A4C40	0160-4554	7		CAPACITOR-FXD .01UF +/-20% 50VDC CER	28480	0160-4554
A4C41	0160-4554	7		CAPACITOR-FXD .01UF +/-20% 50VDC CER	28480	0160-4554
A4C42	0160-2929	8	1	CAPACITOR-FXD 68UF +/-10% 10VDC TA	28480	0160-2929
A4C43	0160-4554	7		CAPACITOR-FXD .01UF +/-20% 50VDC CER	28480	0160-4554
A4C44	0160-0576	5		CAPACITOR-FXD .1UF +/-20% 50VDC CER	28480	0160-0576
A4C45	0160-4554	7		CAPACITOR-FXD .01UF +/-20% 50VDC CER	28480	0160-4554
A4C46	0160-3879	7		CAPACITOR-FXD .01UF +/-20% 100VDC CER	28480	0160-3879
A4C47	0180-0230	8		CAPACITOR-FXD 1.0UF +/-20% 50VDC TA	56289	150D105X0050A2
A4C48	0160-4554	7		CAPACITOR-FXD .01UF +/-20% 50VDC CER	28480	0160-4554
A4C49	0160-0155	8		CAPACITOR-FXD 2.2UF +/-20% 20VDC TA	56289	150D225X0020A2
A4C50	0160-3875	3	2	CAPACITOR-FXD 22PF +/-5% 200VDC CER 0+-30	28480	0160-3875
A4C51	0160-3875	3		CAPACITOR-FXD 22PF +/-5% 200VDC CER 0+-30	28480	0160-3875
A4C52	0160-0374	3	1	CAPACITOR-FXD 10UF +/-10% 20VDC TA	56289	150D106X9020B2
A4CR1	1901-0050	3	8	DIODE-SWITCHING 80V 200MA 2NS DD-35	28480	1901-0050
A4CR2	1901-0050	3		DIODE-SWITCHING 80V 200MA 2NS DD-35	28480	1901-0050
A4CR3	1901-0535	9	2	DIODE-SCHOTTKY	28480	1901-0535
A4CR4	1901-0050	3		DIODE-SWITCHING 80V 200MA 2NS DD-35	28480	1901-0050
A4CR5	1901-0050	3		DIODE-SWITCHING 80V 200MA 2NS DD-35	28480	1901-0050
A4CR6	1901-0050	3		DIODE-SWITCHING 80V 200MA 2NS DD-35	28480	1901-0050
A4CR7	1901-0050	3		DIODE-SWITCHING 80V 200MA 2NS DD-35	28480	1901-0050
A4CR8	1901-0050	3		DIODE-SWITCHING 80V 200MA 2NS DD-35	28480	1901-0050
A4CR9	1901-0050	3		DIODE-SWITCHING 80V 200MA 2NS DD-35	28480	1901-0050
A4CR10	1901-0535	9		DIODE-SCHOTTKY	28480	1901-0535
A4D81	1990-0627	7	1	LED-VISIBLE LUM=INT=1MCD IF=20MA=MAX	28480	1990-0627
A4J2	1251-3076	0	1	CONNECTOR-PC EDGE 18=CONT/ROW 2=ROW8	28480	1251-3076
A4J3	1251-6608	0	2	CONNECTOR 16-PIN M POST TYPE	28480	1251-6608
A4J4	1251-6608	0		CONNECTOR 16-PIN M POST TYPE	28480	1251-6608
A4J5	1251-2026	8	1	CONNECTOR-PC EDGE 18=CONT/ROW 2=ROW8	28480	1251-2026
A4J6	1251-2035	9	1	CONNECTOR-PC EDGE 15=CONT/ROW 2=ROW8	28480	1251-2035
A4L1	9100-0348	2	1	INDUCTORRRF-CH=MLD 1UH 1% .1660X.385LG	28480	9100-0348

See introduction to this section for ordering information
*Indicates factory selected value

Table 6-2. Replaceable Parts (Continued)

Reference Designation	HP Part Number	C D	Qty	Description	Mfr Code	Mfr Part Number
A4Q1	1854-0215	1	7	TRANSISTOR NPN SI PD=350MH FT=300MHZ	04713	2N3904
A4Q2	1854-0215	1		TRANSISTOR NPN SI PD=350MH FT=300MHZ	04713	2N3904
A4Q3	1854-0215	1		TRANSISTOR NPN SI PD=350MH FT=300MHZ	04713	2N3904
A4Q4	1858-0063	5	1	TRANSISTOR ARRAY 14-PIN PLSTC DIP	01928	CA3102E
A4Q5	1858-0040	8	1	TRANSISTOR ARRAY 16-PIN PLSTC DIP	01928	CA3127E
A4Q6	1853-0015	7	4	TRANSISTOR PNP SI PD=200MH FT=500MHZ	28480	1853-0015
A4Q7	1853-0015	7		TRANSISTOR PNP SI PD=200MH FT=500MHZ	28480	1853-0015
A4Q8	1853-0015	7		TRANSISTOR PNP SI PD=200MH FT=500MHZ	28480	1853-0015
A4Q9	1853-0015	7		TRANSISTOR PNP SI PD=200MH FT=500MHZ	28480	1853-0015
A4Q10	1854-0215	1		TRANSISTOR NPN SI PD=350MH FT=300MHZ	04713	2N3904
A4Q11	1854-0215	1		TRANSISTOR NPN SI PD=350MH FT=300MHZ	04713	2N3904
A4Q12	1854-0215	1		TRANSISTOR NPN SI PD=350MH FT=300MHZ	04713	2N3904
A4Q13	1854-0215	1		TRANSISTOR NPN SI PD=350MH FT=300MHZ	04713	2N3904
A4R1	0757-0394	0	3	RESISTOR 51.1 1% .125W F TC0+/-100	24546	C4-1/8-T0-51R1=F
A4R2	1810-0364	9	1	NETWORK-RES 6-SIP470.0 OHM X 5	01121	206A471
A4R3	0757-0419	0	4	RESISTOR 681 1% .125W F TC0+/-100	24546	C4-1/8-T0-681R=F
A4R4	0757-0419	0		RESISTOR 681 1% .125W F TC0+/-100	24546	C4-1/8-T0-681R=F
A4R5	0698-3438	3	1	RESISTOR 147 1% .125W F TC0+/-100	24546	C4-1/8-T0-147R=F
A4R6	0698-0082	7	1	RESISTOR 464 1% .125W F TC0+/-100	24546	C4-1/8-T0-4640=F
A4R7	1810-0203	5	1	NETWORK-RES 8-SIP470.0 OHM X 7	01121	208A471
A4R8	0757-0420	3	2	RESISTOR 750 1% .125W F TC0+/-100	24546	C4-1/8-T0-751=F
A4R9	0757-0280	3	13	RESISTOR 1K 1% .125W F TC0+/-100	24546	C4-1/8-T0-1001=F
A4R10	0757-0280	3		RESISTOR 1K 1% .125W F TC0+/-100	24546	C4-1/8-T0-1001=F
A4R11	0757-0420	3		RESISTOR 750 1% .125W F TC0+/-100	24546	C4-1/8-T0-751=F
A4R12	0698-7211	8	2	RESISTOR 90.9 1% .05W F TC0+/-100	24546	C3-1/8-T00-90R9=G
A4R13	1810-0205	7	1	NETWORK-RES 8-SIP4.7K OHM X 7	01121	208A472
A4R14	1810-0318	3	1	NETWORK-RES 6-SIP1.0K OHM X 5	01121	206A102
A4R15	0757-0419	0		RESISTOR 681 1% .125W F TC0+/-100	24546	C4-1/8-T0-681R=F
A4R16	0757-0419	0		RESISTOR 681 1% .125W F TC0+/-100	24546	C4-1/8-T0-681R=F
A4R17	0698-7260	7	1	RESISTOR 10K 1% .05W F TC0+/-100	24546	C3-1/8-T0-1002=G
A4R18	0698-3440	7	1	RESISTOR 196 1% .125W F TC0+/-100	24546	C4-1/8-T0-196R=F
A4R18	0698-3444	1	1	RESISTOR 316 1% .125W F TC0+/-100	24546	C4-1/8-T0-316R=F
A4R19	0698-7238	9	1	RESISTOR 1.21K 1% .05W F TC0+/-100	24546	C3-1/8-T0-1211=G
A4R20	0757-0394	0		RESISTOR 51.1 1% .125W F TC0+/-100	24546	C4-1/8-T0-51R1=F
A4R21	0698-7211	8		RESISTOR 90.9 1% .05W F TC0+/-100	24546	C3-1/8-T00-90R9=G
A4R22	0757-0401	0	2	RESISTOR 100 1% .125W F TC0+/-100	24546	C4-1/8-T0-101=F
A4R23	0757-0280	3		RESISTOR 1K 1% .125W F TC0+/-100	24546	C4-1/8-T0-1001=F
A4R24	0757-0280	3		RESISTOR 1K 1% .125W F TC0+/-100	24546	C4-1/8-T0-1001=F
A4R25	0757-0280	3		RESISTOR 1K 1% .125W F TC0+/-100	24546	C4-1/8-T0-1001=F
A4R26	0757-0280	3		RESISTOR 1K 1% .125W F TC0+/-100	24546	C4-1/8-T0-1001=F
A4R27	0757-0280	3		RESISTOR 1K 1% .125W F TC0+/-100	24546	C4-1/8-T0-1001=F
A4R28	0757-0280	3		RESISTOR 1K 1% .125W F TC0+/-100	24546	C4-1/8-T0-1001=F
A4R28	0757-0401	0		RESISTOR 100 1% .125W F TC0+/-100	24546	C4-1/8-T0-101=F
A4R29	0757-0280	3		RESISTOR 1K 1% .125W F TC0+/-100	24546	C4-1/8-T0-1001=F
A4R30	0757-0465	6	2	RESISTOR 100K 1% .125W F TC0+/-100	24546	C4-1/8-T0-1003=F
A4R31	0757-0465	6		RESISTOR 100K 1% .125W F TC0+/-100	24546	C4-1/8-T0-1003=F
A4R32	0757-0394	0		RESISTOR 51.1 1% .125W F TC0+/-100	24546	C4-1/8-T0-51R1=F
A4R35	0698-0084	9	1	RESISTOR 2.15K 1% .125W F TC0+/-100	24546	C4-1/8-T0-2151=F
A4R36	0698-3431	6	2	RESISTOR 23.7 1% .125W F TC0+/-100	03888	PME55-1/8-T0-23R7=F
A4R36	0698-3433	6	2	RESISTOR 28.7 1% .125W F TC0+/-100	03888	PME55-1/8-T0-28R7=F
A4R37	0698-3431	6		RESISTOR 23.7 1% .125W F TC0+/-100	03888	PME55-1/8-T0-23R7=F
A4R37	0698-3433	6		RESISTOR 28.7 1% .125W F TC0+/-100	03888	PME55-1/8-T0-28R7=F
A4R38	0757-0441	8	2	RESISTOR 8.25K 1% .125W F TC0+/-100	24546	C4-1/8-T0-8251=F
A4R39	0757-0441	8		RESISTOR 8.25K 1% .125W F TC0+/-100	24546	C4-1/8-T0-8251=F
A4R40	1810-0374	1	1	NETWORK-RES 8-SIP1.0K OHM X 4	01121	208B102
A4R41	0757-0280	3		RESISTOR 1K 1% .125W F TC0+/-100	24546	C4-1/8-T0-1001=F
A4R42	0757-0280	3		RESISTOR 1K 1% .125W F TC0+/-100	24546	C4-1/8-T0-1001=F
A4R43	0757-0442	9	4	RESISTOR 10K 1% .125W F TC0+/-100	24546	C4-1/8-T0-1002=F
A4R44	0757-0442	9		RESISTOR 10K 1% .125W F TC0+/-100	24546	C4-1/8-T0-1002=F
A4R45	0757-0442	9		RESISTOR 10K 1% .125W F TC0+/-100	24546	C4-1/8-T0-1002=F
A4R46	0757-0280	3		RESISTOR 1K 1% .125W F TC0+/-100	24546	C4-1/8-T0-1001=F
A4R47	0757-0442	9		RESISTOR 10K 1% .125W F TC0+/-100	24546	C4-1/8-T0-1002=F
A4R48	1810-0206	8	1	NETWORK-RES 8-SIP10.0K OHM X 7	01121	208A103
A4R49	1810-0365	0	1	NETWORK-RES 6-SIP2.2K OHM X 5	01121	206A222
A4R50	0757-0438	3	2	RESISTOR 5.11K 1% .125W F TC0+/-100	24546	C4-1/8-T0-5111=F
A4R51	0757-0438	3		RESISTOR 5.11K 1% .125W F TC0+/-100	24546	C4-1/8-T0-5111=F
A4R52	0757-1094	9	1	RESISTOR 1.47K 1% .125W F TC0+/-100	24546	C4-1/8-T0-1471=F
A4R53	0757-0280	3		RESISTOR 1K 1% .125W F TC0+/-100	24546	C4-1/8-T0-1001=F
A481	3101-0680	1	1	SWITCH-PB DPDT ALTNG 4A 250VAC	28480	3101-0680
A4U1	1820-0802	1	1	IC GATE ECL NOR QUAD 2-INP	04713	MC10102P
A4U2	1820-0810	1	1	IC RCVR ECL LINE RCVR TPL 2-INP	04713	MC10116P
A4U3	1820-1052	5	1	IC KLTR ECL ECL-TO-TTL QUAD 2-INP	04713	MC10125L
A4U4	1826-0210	7	2	IC COMPARATOR HS 14-DIP=P	27014	LM361N
A4U5	1826-0210	7		IC COMPARATOR HS 14-DIP=P	27014	LM361N

See introduction to this section for ordering information
*Indicates factory selected value

Table 6-2. Replaceable Parts (Continued)

Reference Designation	HP Part Number	C D	Qty	Description	Mfr Code	Mfr Part Number
A4U6	1820-2312	2	1	IC MISC	28480	1820-2312
A4U7	1820-2075	4	3	IC MISC TTL LS	01295	8N74L8245N
A4U8	1820-1989	7	2	IC CNTR TTL LS BIN DUAL 4-BIT	07263	74LS393PC
A4U9	1820-1438	1	2	IC MUXR/DATA-SEL TTL LS 2-TO-1-LINE QUAD	01295	8N74LS257AN
A4U10	1820-1281	2	1	IC DCDR TTL LS 2-TO-4-LINE DUAL 2-INP	01295	8N74LS139N
A4U11	1820-1144	6	1	IC GATE TTL LS NOR QUAD 2-INP	01295	8N74LS02N
A4U12	1820-1416	5	1	IC SCHMITT-TRIG TTL LS INV HEX 1-INP	01295	8N74LS14N
A4U13	1820-1989	7	2	IC CNTR TTL LS BIN DUAL 4-BIT	07263	74LS393PC
A4U14	1820-1438	1	2	IC MUXR/DATA-SEL TTL LS 2-TO-1-LINE QUAD	01295	8N74LS257AN
A4U15	1820-2024	3	2	IC DRVR TTL LS LINE DRVR OCTL	01295	8N74LS244N
A4U16	1820-2075	4	3	IC MISC TTL LS	01295	8N74LS245N
A4U17	1820-1112	8	2	IC FF TTL LS D-TYPE POS-EDGE-TRIG	01295	8N74LS74AN
A4U18	1820-1112	8	2	IC FF TTL LS D-TYPE POS-EDGE-TRIG	01295	8N74LS74AN
A4U19	1820-1240	3	1	IC DCDR TTL S 3-TO-8-LINE 3-INP	01295	8N74LS139N
A4U20	1820-1202	7	1	IC GATE TTL LS NAND TPL 3-INP	01295	8N74LS10N
A4U21	1820-1197	9	1	IC GATE TTL LS NAND QUAD 2-INP	01295	8N74LS00N
A4U22	1818-1249	7	1	IC NMOS 64K ROM 450-NS 3-S	55576	8YP2364 MASKED
A4U23	1818-1250	0	1	IC NMOS 64K ROM 450-NS 3-S	55576	8YP2364 MASKED
A4U24	1820-2075	4	3	IC MISC TTL LS	01295	8N74LS245N
A4U25	1818-0381	6	2	IC NMOS 1K RAM STAT 250-NS	34335	AM9111DPC
A4U26	1818-0381	6	2	IC NMOS 1K RAM STAT 250-NS	34335	AM9111DPC
A4U27	1820-2024	3	2	IC DRVR TTL LS LINE DRVR OCTL	01295	8N74LS244N
A4U28	1820-2099	2	1	IC MICPROC NMOS 8-BIT	04713	MC6802P
A4U29	1826-0275	4	1	IC 78L12A V RGLTR TO-92	04713	MC78L12ACP
A4W1	9158-0005	9	1		28480	9158-0005
A4Y1	0410-0423	2	1	CRYSTAL-QUARTZ 10,000 MHZ	28480	0410-0423
A4Y2	0410-0465	2	1	CRYSTAL-QUARTZ 4,00000 MHZ HC-6/U=HLDR	28480	0410-0465
A4 MISCELLANEOUS PARTS						
	0340-0561	0	2	INSULATOR SLBL=LAC=CPMD	28480	0340-0561
	0340-0587	0	1	INSULATOR SLBL=LAC=CPMD	28480	0340-0587
	0360-16A2	0	2	TERMINAL-STUD SGL-TUR PRESS=MTG	28480	0360-1682
	1200-0475	0	3	CONNECTOR-SGL CONT SKY .016-IN=BSC-SZ	28480	1200-0475
	1200-0519	3	1	SOCKET-IC 16-CONT DIP=SLDR	28480	1200-0519
	1200-0522	8	2	SOCKET-IC 24-CONT DIP=SLDR	28480	1200-0522
	1200-0682	1	2	SCKET-IC 40-CONT DIP DIP=SLDR	28480	1200-0682
	1251-4707	6	11	CONNECTOR-SGL CONT PIN .031-IN=BSC-SZ	28480	1251-4707
	5040-0201	4	1	BEZELICOUNTER(ATTEN)LIGHT GRAY	28480	5040-0201

See introduction to this section for ordering information
*Indicates factory selected value

Table 6-2. Replaceable Parts (Continued)

Reference Designation	HP Part Number	C D	Qty	Description	Mfr Code	Mfr Part Number
A5	05335-60005	1	1	BOARD ASSEMBLY-DISPLAY	28480	05335-60005
A5C2	0160-3879	7	4	CAPACITOR-FXD .01UF +-20% 100VDC CER	28480	0160-3879
A5C3	0180-0137	6	1	CAPACITOR-FXD 100UF+-20% 10VDC TA	56289	150D107X0010R2
A5C4	0160-3879	7		CAPACITOR-FXD .01UF +-20% 100VDC CER	28480	0160-3879
A5C5	0160-3879	7		CAPACITOR-FXD .01UF +-20% 100VDC CER	28480	0160-3879
A5C6	0160-3879	7		CAPACITOR-FXD .01UF +-20% 100VDC CER	28480	0160-3879
A5CR1-						
A5CR34	1990-0670	0	34	LED-VISIBLE LUM-INT=1MCD IF=20MA=MAX	28480	1990-0670
A5CR35	1990-0486	6	10	LED-VISIBLE LUM-INT=1MCD IF=20MA=MAX	28480	5082-4684
A5CR36	1990-0486	6		LED-VISIBLE LUM-INT=1MCD IF=20MA=MAX	28480	5082-4684
A5CR37	1990-0486	6		LED-VISIBLE LUM-INT=1MCD IF=20MA=MAX	28480	5082-4684
A5CR38	1990-0486	6		LED-VISIBLE LUM-INT=1MCD IF=20MA=MAX	28480	5082-4684
A5CR39	1990-0486	6		LED-VISIBLE LUM-INT=1MCD IF=20MA=MAX	28480	5082-4684
A5CR40	1990-0486	6		LED-VISIBLE LUM-INT=1MCD IF=20MA=MAX	28480	5082-4684
A5CR41	1990-0486	6		LED-VISIBLE LUM-INT=1MCD IF=20MA=MAX	28480	5082-4684
A5CR42	1990-0486	6		LED-VISIBLE LUM-INT=1MCD IF=20MA=MAX	28480	5082-4684
A5CR43	1990-0486	6		LED-VISIBLE LUM-INT=1MCD IF=20MA=MAX	28480	5082-4684
A5CR44	1990-0486	6		LED-VISIBLE LUM-INT=1MCD IF=20MA=MAX	28480	5082-4684
A5D81	1990-0574	3	13	DISPLAY=NUM=SEG 1=CHAR .43=H	28480	5082-7651
A5D82	1990-0574	3		DISPLAY=NUM=SEG 1=CHAR .43=H	28480	5082-7651
A5D83	1990-0574	3		DISPLAY=NUM=SEG 1=CHAR .43=H	28480	5082-7651
A5D84	1990-0574	3		DISPLAY=NUM=SEG 1=CHAR .43=H	28480	5082-7651
A5D85	1990-0574	3		DISPLAY=NUM=SEG 1=CHAR .43=H	28480	5082-7651
A5D86	1990-0574	3		DISPLAY=NUM=SEG 1=CHAR .43=H	28480	5082-7651
A5D87	1990-0574	3		DISPLAY=NUM=SEG 1=CHAR .43=H	28480	5082-7651
A5D88	1990-0574	3		DISPLAY=NUM=SEG 1=CHAR .43=H	28480	5082-7651
A5D89	1990-0574	3		DISPLAY=NUM=SEG 1=CHAR .43=H	28480	5082-7651
A5D810	1990-0574	3		DISPLAY=NUM=SEG 1=CHAR .43=H	28480	5082-7651
A5D811	1990-0574	3		DISPLAY=NUM=SEG 1=CHAR .43=H	28480	5082-7651
A5D812	1990-0574	3		DISPLAY=NUM=SEG 1=CHAR .43=H	28480	5082-7651
A5D813	1990-0681	3	1	DISPLAY=AN=SEG 1=CHAR .408=H RED	28480	5082-7656
A5D814	1990-0574	3		DISPLAY=NUM=SEG 1=CHAR .43=H	28480	5082-7651
A5J1	1251-6600	0	1	CONNECTOR-SGL CONT PIN 1.14-MM-BSC-SZ SQ	28480	1251-6600
A5J2	1251-6608	0	1	CONNECTOR 16-PIN M POST TYPE	28480	1251-6608
A5R1	0699-0069	2	1	RESISTOR 2.15K 1% .125W F TC=0+-100	28480	0699-0069
A5R2	0698-0084	9	1	RESISTOR 2.15K 1% .125W F TC=0+-100	24546	C4-1/8-T0-2151-F
A5R3	2100-3792	9	1	RESISTOR-VAR CONTROL CC 1M 10% 10CW	01121	HP460328105AA
A5R4	1810-0205	7	1	NETWORK-RES 8-SIP4,7K OHM X 7	01121	208A472
A5U1	1820-2132	4	3	IC DRVR CMOS LED DRVR	32293	ICM7218A
A5U2	1820-2132	4		IC DRVR CMOS LED DRVR	32293	ICM7218A
A5U3	1820-1207	2	1	IC GATE TTL LS NAND 8-INP	01295	8N74LS30N
A5U4	1820-1195	7	1	IC FF TTL LS D-TYPE POS-EDGE-TRIG CDM	01295	8N74LS175N
A5U5	1820-1858	9	1	IC FF TTL LS D-TYPE OCTL	01295	8N74LS377N
A5U6	1820-1641	8	1	IC DRVR TTL LS BUS DRVR HEX 1-INP	01295	8N74LS365AN
A5U7	1820-2132	4		IC DRVR CMOS LED DRVR	32293	ICM7218A
A5XD81-						
A5XD81a	1200-0679	6	14	SOCKET-IC 14-CONT DIP DIP-SLDR	28480	1200-0679
A5 MISCELLANEOUS PARTS						
	1251-6023	3	1	CONNECTOR 16-PIN M POST TYPE	28480	1251-6023
	4040-1614	4	9		28480	4040-1614
	4040-1615	5	1		28480	4040-1615
	5041-0252	7	8		28480	5041-0252
	5041-0253	8	16		28480	5041-0253
	5041-0276	5	1		28480	5041-0276
	5041-0450	7	3		28480	5041-0450
	5041-0318	6	2	*LK CAP= PTY GRAY	28480	5041-0318
	5041-1732	0	1		28480	5041-1732
	5041-0319	7	2		28480	5041-0319
	5041-1733	1	1		28480	5041-1733
	5060-9436	7	34	PUSHBUTTON SWITCH P.C. MOUNT	28480	5060-9436
	8159-0005	0	1	WIRE 22AWG W PVC 1X22 80C	28480	8159-0005

See introduction to this section for ordering information
*Indicates factory selected value

Table 6-2. Replaceable Parts (Continued)

Reference Designation	HP Part Number	C D	Qty	Description	Mfr Code	Mfr Part Number
A6	05335-60006	2	1	BOARD ASSEMBLY-REAR	28480	05335-60006
A6C1	0160-4557	0	5	CAPACITOR-FXD .1UF +-20% 50VDC CER	16299	CAC04X7R104M050A
A6C2	0160-0210	6	3	CAPACITOR-FXD 3.3UF+-20% 15VDC TA	56289	1500335X0015A2
A6C3	0160-4554	7	5	CAPACITOR-FXD .01UF +-20% 50VDC CER	28480	0160-4554
A6C4	0160-0210	6	6	CAPACITOR-FXD 3.3UF+-20% 15VDC TA	56289	1500335X0015A2
A6C5	0160-4557	0	7	CAPACITOR-FXD .1UF +-20% 50VDC CER	16299	CAC04X7R104M050A
A6C6	0160-0210	6	6	CAPACITOR-FXD 3.3UF+-20% 15VDC TA	56289	1500335X0015A2
A6C7	0160-4557	7	7	CAPACITOR-FXD .1UF +-20% 50VDC CER	16299	CAC04X7R104M050A
A6C8	0160-3046	0	4	CAPACITOR-FXD 250PF +-1% 100VDC MICA	28480	0160-3046
A6C9	0160-4554	7	7	CAPACITOR-FXD .01UF +-20% 50VDC CER	28480	0160-4554
A6C11	0160-3874	2	2	CAPACITOR-FXD 10PF +-5PF 200VDC CER	28480	0160-3874
A6C12	0160-3874	2	7	CAPACITOR-FXD 10PF +-5PF 200VDC CER	28480	0160-3874
A6C12	0160-4554	7	2	CAPACITOR-FXD .01UF +-20% 50VDC CER	28480	0160-4554
A6C13	0160-3046	0	0	CAPACITOR-FXD 250PF +-1% 100VDC MICA	28480	0160-3046
A6C14	0160-3046	0	0	CAPACITOR-FXD 250PF +-1% 100VDC MICA	28480	0160-3046
A6C15	0160-4554	7	7	CAPACITOR-FXD .01UF +-20% 50VDC CER	28480	0160-4554
A6C16	0160-4554	7	7	CAPACITOR-FXD .01UF +-20% 50VDC CER	28480	0160-4554
A6C17	0160-4557	0	0	CAPACITOR-FXD .1UF +-20% 50VDC CER	16299	CAC04X7R104M050A
A6C18	0160-4557	0	0	CAPACITOR-FXD .1UF +-20% 50VDC CER	16299	CAC04X7R104M050A
A6C19	0160-3046	0	4	CAPACITOR-FXD 250PF +-1% 100VDC MICA	28480	0160-3046
A6C20	0160-0682	4	1	CAPACITOR-FXD 3.3PF +-5PF 200VDC CER	28480	0160-0682
A6CR2	1901-0050	3	5	DIODE-SWITCHING 80V 200MA 2NS DO-35	28480	1901-0050
A6CR3	1901-0050	3	3	DIODE-SWITCHING 80V 200MA 2NS DO-35	28480	1901-0050
A6CR4	1901-0535	9	2	DIODE-SCHOTTKY	28480	1901-0535
A6CR5	1901-0050	3	3	DIODE-SWITCHING 80V 200MA 2NS DO-35	28480	1901-0050
A6CR6	1901-0050	3	3	DIODE-SWITCHING 80V 200MA 2NS DO-35	28480	1901-0050
A6CR7	1901-0535	9	3	DIODE-SCHOTTKY	28480	1901-0535
A6CR8	1901-0050	3	3	DIODE-SWITCHING 80V 200MA 2NS DO-35	28480	1901-0050
A6J1	1250-1453	1	6	CONNECTOR-RF BNC FEM SGL-HOLE-RR 50-OHM	28480	1250-1453
A6J2	1250-1453	1	1	CONNECTOR-RF BNC FEM SGL-HOLE-RR 50-OHM	28480	1250-1453
A6J3	1250-1453	1	1	CONNECTOR-RF BNC FEM SGL-HOLE-RR 50-OHM	28480	1250-1453
A6J4	1250-1453	1	1	CONNECTOR-RF BNC FEM SGL-HOLE-RR 50-OHM	28480	1250-1453
A6J5	1250-1453	1	1	CONNECTOR-RF BNC FEM SGL-HOLE-RR 50-OHM	28480	1250-1453
A6J6	1250-1453	1	1	CONNECTOR-RF BNC FEM SGL-HOLE-RR 50-OHM	28480	1250-1453
A6L1	9100-0348	2	3	INDUCTOR-RF=CH=MLD 1UH 1% .166DX,385LG	28480	9100-0348
A6L2	9100-0348	2	2	INDUCTOR-RF=CH=MLD 1UH 1% .166DX,385LG	28480	9100-0348
A6L3	9100-0348	2	2	INDUCTOR-RF=CH=MLD 1UH 1% .166DX,385LG	28480	9100-0348
A6Q1	1854-0215	1	6	TRANSISTOR NPN SI PD=350MW FT=300MHZ	04713	2N3904
A6Q2	1854-0215	1	1	TRANSISTOR NPN SI PD=350MW FT=300MHZ	04713	2N3904
A6Q3	1854-0215	1	1	TRANSISTOR NPN SI PD=350MW FT=300MHZ	04713	2N3904
A6Q4	1853-0036	2	1	TRANSISTOR PNP SI PD=310MW FT=250MHZ	28480	1853-0036
A6Q5	1854-0215	1	1	TRANSISTOR NPN SI PD=350MW FT=300MHZ	04713	2N3904
A6Q6	1854-0215	1	1	TRANSISTOR NPN SI PD=350MW FT=300MHZ	04713	2N3904
A6Q7	1854-0215	1	1	TRANSISTOR NPN SI PD=350MW FT=300MHZ	04713	2N3904
A6R1	0757-0401	0	1	RESISTOR 100 1% .125W F TC=0+-100	24546	C4-1/8-T0-101-F
A6R2	0698-3162	0	1	RESISTOR 46.4K 1% .125W F TC=0+-100	24546	C4-1/8-T0-4642-F
A6R3	0757-0405	4	1	RESISTOR 162 1% .125W F TC=0+-100	24546	C4-1/8-T0-162H-F
A6R4	0757-0280	3	4	RESISTOR 1K 1% .125W F TC=0+-100	24546	C4-1/8-T0-1001-F
A6R5	0698-3155	1	1	RESISTOR 4.64K 1% .125W F TC=0+-100	24546	C4-1/8-T0-4641-F
A6R6	1810-0367	2	1	NETWORK-RES 6-SIP4,7K UHM X 5	01121	206A472
A6R7	0698-0084	9	1	RESISTOR 2.15K 1% .125W F TC=0+-100	24546	C4-1/8-T0-2151-F
A6R9	0698-3444	1	1	RESISTOR 316 1% .125W F TC=0+-100	24546	C4-1/8-T0-316R-F
A6R10	0757-0280	3	3	RESISTOR 1K 1% .125W F TC=0+-100	24546	C4-1/8-T0-1001-F
A6R11	0757-1093	8	2	RESISTOR 3K 1% .125W F TC=0+-100	24546	C4-1/8-T0-3001-F
A6R12	0757-1094	9	1	RESISTOR 1.47K 1% .125W F TC=0+-100	24546	C4-1/8-T0-1471-F
A6R13	0757-0442	9	2	RESISTOR 10K 1% .125W F TC=0+-100	24546	C4-1/8-T0-1002-F
A6R14	0757-0178	8	1	RESISTOR 100 1% .25W F TC=0+-100	24546	C5-1/4-T0-101-F
A6R15	0757-1093	8	1	RESISTOR 3K 1% .125W F TC=0+-100	24546	C4-1/8-T0-3001-F
A6R16	0757-0439	4	1	RESISTOR 6.81K 1% .125W F TC=0+-100	24546	C4-1/8-T0-6811-F
A6R17	0757-0442	9	1	RESISTOR 10K 1% .125W F TC=0+-100	24546	C4-1/8-T0-1002-F
A6R18	0757-0280	3	3	RESISTOR 1K 1% .125W F TC=0+-100	24546	C4-1/8-T0-1001-F
A6R19	0757-0280	3	3	RESISTOR 1K 1% .125W F TC=0+-100	24546	C4-1/8-T0-1001-F
A6S*1	3101-2383	5	2	SWITCH-SL DP3T MINTR .5A 125VAC PC	28480	3101-2383
A6S*2	3101-2383	5	2	SWITCH-SL DP3T MINTR .5A 125VAC PC	28480	3101-2383
	1200-0519	3	1	SOCKET-IC 16-CONT DIP-SLDR	28480	1200-0519

See introduction to this section for ordering information
*Indicates factory selected value

Table 6-2. Replaceable Parts (Continued)

Reference Designation	HP Part Number	C D	Qty	Description	Mfr Code	Mfr Part Number
A7	05335-60007	3	1	BOARD ASSEMBLY-HP-18	28480	05335-60007
A7C1	0160-3879	7	5	CAPACITOR-FXD .01UF +-20% 100VDC CER	28480	0160-3879
A7C2	0160-3879	7		CAPACITOR-FXD .01UF +-20% 100VDC CER	28480	0160-3879
A7C3	0180-0374	3	1	CAPACITOR-FXD 10UF+-10% 20VDC TA	56289	150D106X902082
A7C4	0160-3879	7		CAPACITOR-FXD .01UF +-20% 100VDC CER	28480	0160-3879
A7C5	0160-3879	7		CAPACITOR-FXD .01UF +-20% 100VDC CER	28480	0160-3879
A7C6	0160-3879	7		CAPACITOR-FXD .01UF +-20% 100VDC CER	28480	0160-3879
A7J1	1200-0519	3	2	SOCKET-IC 16-CONT DIP-8LDR	28480	1200-0519
A7J2	1200-0519	3		SOCKET-IC 16-CONT DIP-8LDR	28480	1200-0519
A7R1	1A10-0205	7	1	NETWORK-RES 8-SIP4.7K OHM X 7	01121	208A472
A7U1	1A20-2219	8	1	IC MICPROC-ACCESS N'08 8-BIT	04713	MC68488P
A7U2	1A20-1281	2	1	IC DCOR TTL LS 2-YO-4-LINE DUAL 2-INP	01295	SN74LS139N
A7U3	1A20-2058	3	4	IC MISC TTL S QUAD	28480	1820-2058
A7U4	1A20-2058	3		IC MISC TTL S QUAD	28480	1820-2058
A7U5	1A20-1199	1	1	IC INV TTL LS HEX 1-INP	01295	SN74LS04N
A7U6	1A20-2058	3		IC MISC TTL S QUAD	28480	1820-2058
A7U7	1A20-2058	3		IC MISC TTL S QUAD	28480	1820-2058
A7U8	1A20-2024	3	1	IC DRVR TTL LS LINE DRVR OCTL	01295	SN74LS244N
	1200-0552	4	1	SOCKET-IC 40-CONT DIP-8LDR	28480	1200-0552
A8			1	OPTION 020, DVM, REFER TO TABLE 6-4		
A9			1	OPTION 030, CHANNEL C, REFER TO TABLE 6-5		
A10				NOT ASSIGNED		
A11						
A12						

See introduction to this section for ordering information
*Indicates factory selected value

Table 6-2. Replaceable Parts (Continued)

Reference Designation	HP Part Number	C D	Qty	Description	Mfr Code	Mfr Part Number
A13	0960-0448	6	1	LINE MODULE= FILTERED	05245	F1927
A14	05370-60005	4	1	BOARD ASSEMBLY, HP-18 CONNECTOR	28480	05370-60005
A14J1	1200-0519	3	2	SOCKET-IC 16-CONT DIP-SLDR	28480	1200-0519
A14J2	1200-0519	3	1	SOCKET-IC 16-CONT DIP-SLDR	28480	1200-0519
A14J3	1251-32A3	1	1	CONNECTOR 24-PIN F MICRORIBBON	28480	1251-32B3
A14SW1	3101-1973	7	1	SWITCH-SL 7-1A DIP-SLIDE-ASSY ,1A 50VDC	28480	3101-1973
A14X81	1200-0485	2	1	SOCKET-IC 14-CONT DIP DIP-SLDR	28480	1200-0485
				A14 MISCELLANEOUS PARTS		
	0360-0643	1	2	BARRIER BLOCK 2-TERM FEED-THRU SLDR STUD	28480	0360-0643
	1530-1098	4	2	CLEVIS 0.070-IN W SLT 0.454-IN PIN CTR	00000	ORDER BY DESCRIPTION
	2190-0017	4	2	WASHER=LK HLCL NO. 8 .168-IN-ID	28480	2190-0017

See introduction to this section for ordering information
*Indicates factory selected value

Table 6-2. Replaceable Parts (Continued)

Reference Designation	HP Part Number	C D	Qty	Description	Mfr Code	Mfr Part Number
CHASSIS PARTS						
B1	3100-0209	4	1	FAN-TBAX 32-CFM 105-125V 50/60-HZ	23936	8500C
F1	2110-0007	4	1	FUSE 1A 250V TD 1.25X.25 UL	75915	313001
Q1	1854-0611	1	1	TRANSISTOR NPN 2N6055 SI DARL TO-3	04713	2N6055
T1	9100-4113	7	1	TRANSFORMER	28480	9100-4113
W1	8120-1378	1	1	CABLE ASSY 18AWG 3-CNDCT JGK-JKT	28480	8120-1378
W2	05335-60101	8	1	CABLE ASSEMBLY-POWER	28480	05335-60101
W3	8120-2884	6	1		28480	8120-2884
W4	05335-60102	9	1	CABLE ASSEMBLY-DISPLAY	28480	05335-60102
W5	8120-2867	5	2		28480	8120-2867
W6	8120-2867	5			28480	8120-2867
W7	05335-60103	0	2	CABLE-COAX	28480	05335-60103
W8	05335-60103	0		CABLE-COAX	28480	05335-60103
W9	8120-2959	6	2		28480	8120-2959
W10	8120-2959	6			28480	8120-2959
MISCELLANEOUS PARTS						
	0340-0468	6	5	INSULATOR-XSTR NYLON	28480	0340-0468
	0340-0486	8	1	INSULATOR-COVER NYLON	28480	0340-0486
	0340-0525	6	5	INSULATOR-XSTR ALUMINUM HD-ANDZ	28480	0340-0525
	0370-1005	2	3	KNOB-BASE-PTR 3/8 JGK .125-IN-ID	28480	0370-1005
	0510-1148	2	13	RETAINER-PUSH ON KB-TO-SHFT EXT	28480	0510-1148
	05335-00001	1	1	PANEL-FRONT, MAIN	28480	05335-00001
	05335-00002	2	2	PANEL-FRONT (OPTION)	28480	05335-00002
	05335-00003	3	1	PANEL-SUB	28480	05335-00003
	05335-00004	4	1	PANEL-REAR	28480	05335-00004
	05335-00009	9	1	SHIELD-PROTECT	28480	05335-00009
	05335-00010	2	1	SUPPORT-HP-18	28480	05335-00010
	05335-20201	5	1	WINDOW	28480	05335-20201
	05335-40001	5	2	CROSS MEMBER	28480	05335-40001
	1200-0043	8	1	INSULATOR-XSTR ALUMINUM	28480	1200-0043
	1200-0523	9	6	LOCK-DUAL INLINE PKG INLINE PKG	52072	CA-16-200-DL
	1200-0617	2	2	LOCK-DIP IC FOR 18 PIN SOCKET	52072	CA-18-200-DL
	1460-1345	5	4	TILT STAND SST	28480	1460-1345
	3160-0309	5	1	FINGER GUARD	0653A	12601-43 UL VERSION
	5020-8803	6	1	FRAME-FRONT	28480	5020-8803
	5020-8804	7	1	FRAME-REAR	28480	5020-8804
	5020-8835	4	4	STRUT-CORNER	28480	5020-8835
	5020-8896	7	2	HANDLE TRIM-FRONT	28480	5020-8896
	5040-6928	4	1	STRIP-DIVIDER	28480	5040-6928
	5040-6937	5	3	WINDOW CLIP	28480	5040-6937
	5040-7201	8	2	FOOT(STANDARD)	28480	5040-7201
	5040-7202	9	1	TRIM, TOP	28480	5040-7202
	5040-7219	8	1	STRAP, HANDLE, CAP-FRONT	28480	5040-7219
	5040-7220	1	1	STRAP, HANDLE, CAP-REAR	28480	5040-7220
	5040-7222	3	2	FOOT-NON-SKID	28480	5040-7222
	5060-9802	1	1	STRAP-HANDLE	28480	5060-9802
	5060-9833	8	1	COVER, TOP 12" DP	28480	5060-9833
	5060-9845	2	1	COVER, BOTTOM	28480	5060-9845
	5060-9878	1	1	COVER-SIDE	28480	5060-9878
	5060-9899	6	2	SYS II HANDLES	28480	5060-9899
	5060-9910	2	1	COVER-SIDE	28480	5060-9910
	05335-00002	2	1	PANEL-FRONT (OPTION)	28480	05335-00002
	05335-00007	7	1	PANEL-DVM	28480	05335-00007
	7120-3731	3	1	LABEL-HV WARNING	28480	7120-3731
	7120-8385	3	1	LABEL-INFO (5335A)	28480	7120-8385

See introduction to this section for ordering information
*Indicates factory selected value

Table 6-3. Option 010 Replaceable Parts

Reference Designation	HP Part Number	C D	Qty	Description	Mfr Code	Mfr Part Number
A15	10544	8	1	10 MHZ OVEN OSCILLATOR (OPTION 010)	28480	10544

See introduction to this section for ordering information
 *Indicates factory selected value

Table 6-4. Option 020 Replaceable Parts

Reference Designation	HP Part Number	C D	Qty	Description	Mfr Code	Mfr Part Number
AB	05335-60008	4	1	BOARD ASSEMBLY-DYM (OPTION 020)	28480	05335-60008
ABC1	0180-2730	9	2	CAPACITOR-FXD 1700UF+75-10% 30VDC AL	28480	0180-2730
ABC2	0180-2730	9	2	CAPACITOR-FXD 1700UF+75-10% 30VDC AL	28480	0180-2730
ABC3	0160-0576	5	4	CAPACITOR-FXD .1UF +/-20% 50VDC CER	28480	0160-0576
ABC4	0160-0576	5	4	CAPACITOR-FXD .1UF +/-20% 50VDC CER	28480	0160-0576
ABC5	0160-4557	0	1	CAPACITOR-FXD .1UF +/-20% 50VDC CER	16299	CAC04X7R104M050A
ABC6	0180-2821	9	2	CAPACITOR-FXD 22UF+/-20% 35VDC 1A	28480	0180-2821
ABC7	0180-2821	9	2	CAPACITOR-FXD 22UF+/-20% 35VDC 2A	28480	0180-2821
ABC8	0160-0300	3	1	CAPACITOR-FXD 2700PF +/-10% 200VDC POLYE	28480	0160-0300
ABC10	0160-0576	5	4	CAPACITOR-FXD .1UF +/-20% 50VDC CER	28480	0160-0576
ABC11	0160-0576	5	4	CAPACITOR-FXD .1UF +/-20% 50VDC CER	28480	0160-0576
ABC12	0160-4554	7	5	CAPACITOR-FXD .01UF +/-20% 50VDC CER	28480	0160-4554
ABC13	0160-4554	7	5	CAPACITOR-FXD .01UF +/-20% 50VDC CER	28480	0160-4554
ABC14	0160-4554	7	5	CAPACITOR-FXD .01UF +/-20% 50VDC CER	28480	0160-4554
ABC15	0160-4554	7	5	CAPACITOR-FXD .01UF +/-20% 50VDC CER	28480	0160-4554
ABC16	0160-4554	7	5	CAPACITOR-FXD .01UF +/-20% 50VDC CER	28480	0160-4554
ABC17	0160-4801	7	1	CAPACITOR-FXD 100PF +/-5% 100VDC CER	28480	0160-4801
ABC18	0160-0314	9	1	CAPACITOR-FXD .01UF +/-5% 400VDC POLYE	84411	663UM10354W2
ABCR1	1906-0069	4	1	DIODE-FW BRDG 400V 1A	28480	1906-0069
ABCR2	1901-0033	2	1	DIODE-GEN PRP 180V 200MA DO-7	28480	1901-0033
ABCR3	1901-0050	3	2	DIODE-SWITCHING 80V 200MA 2N8 DO-35	28480	1901-0050
ABCR4	1901-0050	3	2	DIODE-SWITCHING 80V 200MA 2N8 DO-35	28480	1901-0050
ABQ3	1853-0036	2	2	TRANSISTOR PNP SI PD=310MW FT=250MHZ	28480	1853-0036
ABQ4	1854-0215	1	3	TRANSISTOR NPN SI PD=350MW FT=300MHZ	04713	2N3904
ABQ4	1855-0368	7	3	TRANSISTOR J-FET N-CHAN D-MODE TO-72 SI	28480	1855-0368
ABQ5	1854-0215	1	3	TRANSISTOR NPN SI PD=350MW FT=300MHZ	04713	2N3904
ABQ5	1855-0368	7	3	TRANSISTOR J-FET N-CHAN D-MODE TO-72 SI	28480	1855-0368
ABQ6	1854-0215	1	3	TRANSISTOR NPN SI PD=350MW FT=300MHZ	04713	2N3904
ABQ6	1855-0368	7	3	TRANSISTOR J-FET N-CHAN D-MODE TO-72 SI	28480	1855-0368
ABQ7	1853-0036	2	2	TRANSISTOR PNP SI PD=310MW FT=250MHZ	28480	1853-0036
ABR1	0757-0428	1	1	RESISTOR 1.62K 1% .125W F TC=0+-100	24546	C4=1/8-T0-1621-F
ABR2	2100-3094	4	3	RESISTOR-TRMR 100K 10% C SIDE-ADJ 17-TRN	02111	43P104
ABR3	0757-0286	9	3	RESISTOR 100 1% .125W F TC=0+-25	19701	MF4C1/8-T9-101-F
ABR4	0698-6964	6	1	RESISTOR 49.5K 1% .125W F TC=0+-25	28480	0698-6964
ABR6	0698-0082	7	1	RESISTOR 464 1% .125W F TC=0+-100	24546	C4=1/8-T0-4640-F
ABR7	0698-3155	1	1	RESISTOR 4.64K 1% .125W F TC=0+-100	24546	C4=1/8-T0-4641-F
ABR8	0698-4008	5	1	RESISTOR 40K 1% .125W F TC=0+-100	24546	C4=1/8-T0-4002-F
ABR9	0698-3162	0	5	RESISTOR 46.4K 1% .125W F TC=0+-100	24546	C4=1/8-T0-4642-F
ABR10	2100-3154	7	1	RESISTOR-TRMR 1K 10% C SIDE-ADJ 17-TRN	02111	43P102
ABR11	0698-6964	6	1	RESISTOR 49.5K 1% .125W F TC=0+-25	28480	0698-6964
ABR12	0698-3162	0	1	RESISTOR 46.4K 1% .125W F TC=0+-100	24546	C4=1/8-T0-4642-F
ABR13	0698-6606	3	1	RESISTOR 495K 1% .125W F TC=0+-25	28480	0698-6606
ABR14	0698-3162	0	1	RESISTOR 46.4K 1% .125W F TC=0+-100	24546	C4=1/8-T0-4642-F
ABR15	2100-3103	6	1	RESISTOR-TRMR 10K 10% C SIDE-ADJ 17-TRN	02111	43P103
ABR16	0757-0442	9	6	RESISTOR 10K 1% .125W F TC=0+-100	24546	C4=1/8-T0-1002-F
ABR17	0757-0442	9	6	RESISTOR 10K 1% .125W F TC=0+-100	24546	C4=1/8-T0-1002-F
ABR18	0757-0465	6	1	RESISTOR 100K 1% .125W F TC=0+-100	24546	C4=1/8-T0-1003-F
ABR19	2100-3094	4	4	RESISTOR-TRMR 100K 10% C SIDE-ADJ 17-TRN	02111	43P104
ABR20	0757-0442	9	4	RESISTOR 10K 1% .125W F TC=0+-100	24546	C4=1/8-T0-1002-F
ABR21	0698-7959	1	1	RESISTOR 4.95M 1% 1W F TC=0+-25	28480	0698-7959
ABR22	0698-3162	0	1	RESISTOR 46.4K 1% .125W F TC=0+-100	24546	C4=1/8-T0-4642-F
ABR23	1810-0374	1	1	NETWORK-RES 8-SIP1.0K OHM X 4	01121	2088102
ABR24	0757-0442	9	1	RESISTOR 10K 1% .125W F TC=0+-100	24546	C4=1/8-T0-1002-F
ABR25	0757-0442	9	1	RESISTOR 10K 1% .125W F TC=0+-100	24546	C4=1/8-T0-1002-F
ABR26	0698-6367	3	1	RESISTOR 22.22 1% .125W F TC=0+-25	28480	0698-6367
ABR27	0698-6964	6	1	RESISTOR 49.5K 1% .125W F TC=0+-25	28480	0698-6964
ABR29	0698-3931	1	1	RESISTOR 2M 1% .125W F TC=0+-25	28480	0698-3931
ABR29	0757-0442	9	4	RESISTOR 10K 1% .125W F TC=0+-100	24546	C4=1/8-T0-1002-F
ABR30	2100-3094	4	4	RESISTOR-TRMR 100K 10% C SIDE-ADJ 17-TRN	02111	43P104
ABR31	0698-3162	0	1	RESISTOR 46.4K 1% .125W F TC=0+-100	24546	C4=1/8-T0-4642-F
ABR31	0698-3964	0	1	RESISTOR 8M .5% .25W F TC=0+-25	03888	PME64T98M.5X
ABT1	9100-0439	2	1	TRANSFORMER-ISOLATION 35.4V +/-13.7%	28480	9100-0439
ABU1	1826-0625	8	1	OPTO-ISOLATOR LED-IC GATE IF=10MA-MAX	28480	1826-0625
ABU2	1990-0429	7	1	IC FF TTL LS D-TYPE POS=EDGE-TRIG COM	28480	1990-0429
ABU3	1820-1195	7	1	IC FF TTL LS D-TYPE POS=EDGE-TRIG COM	01295	8N74LS175N
ABU4	1826-0650	9	1	IC OP AMP LOW-OFS 8-DIP=P	28480	1826-0650
ABU5	1826-0635	0	2	IC OP AMP LOW-OFS 8-DIP=P	06665	OP=07CP
ABU6	1826-0624	7	1	IC CONV V/FREQ 14-DIP=P	8E175	VFC32KQ
ABU7	1826-0610	1	1	IC MULTIPLEXR 4-CHAN-ANLG DUAL 16-DIP=C	06665	MUX24FQ
ABU8	1826-0635	0	1	IC OP AMP LOW-OFS 8-DIP=P	06665	OP=07CP
ABU9	1990-0543	6	4	OPTO-ISOLATOR LED-PXSTR IF=150MA-MAX	01295	TIL116
AAU10	1990-0543	6	4	OPTO-ISOLATOR LED-PXSTR IF=150MA-MAX	01295	TIL116

See introduction to this section for ordering information
*Indicates factory selected value

Table 6-4. Option 020 Replaceable Parts (Continued)

Reference Designation	HP Part Number	C D	Qty	Description	Mfr Code	Mfr Part Number
ABU11	1826-0627	0	1	IC OP AMP PRCN TO-99	24355	AD542L
ABU12	1990-0543	6		OPTO-ISOLATOR LED-PXSTR IF=150MA-MAX	01295	TIL116
ABU13	1990-0543	6		OPTO-ISOLATOR LED-PXSTR IF=150MA-MAX	01295	TIL116
ABW1	05335-60110	9	1	CABLE ASSEMBLY=DVM +	28480	05335-60110
ABW2	05335-60111	0	1	CABLE ASSEMBLY=DVM -	28480	05335-60111
				AB MISCELLANEOUS PARTS		
	0340-0060	4	2	TERMINAL-STUD SPCL-FDTHRU PRESS-MTG	98291	011-6809 000 209
	0360-0124	3	2	CONNECTOR-SGL CONT PIN .04-IN-BSC-SZ RND	28480	0360-0124
	0360-1682	0	4	TERMINAL-STUD SGL-TUR PRESS-MTG	28480	0360-1682
	0380-0310	1	2	STANDOFF-RVT-0N .75-IN-LG 6-32TMD	00000	ORDER BY DESCRIPTION
	0380-0311	2	1	STANDOFF-RVT-0N .5-IN-LG 6-32TMD	00000	ORDER BY DESCRIPTION
	05335-00011	3	1	SHIELD=DVM	28480	05335-00011
	05335-00002	2		PANEL=FRONT (OPT)	28480	05335-00002
	05335-00007	7	1	PANEL=DVM	28480	05335-00007

See introduction to this section for ordering information
 *Indicates factory selected value

Table 6-5. Option 030 Replaceable Parts

Reference Designation	HP Part Number	C D	Qty	Description	Mfr Code	Mfr Part Number
A9	05335-60009	5	1	BOARD ASSEMBLY=CHANNEL C (OPTION 030)	28480	05335-60009
A9C1	0160-0576	5	17	CAPACITOR=FXD .1UF +-20% 50VDC CER	28480	0160-0576
A9C2	0160-2617	1	5	CAPACITOR=FXD 6.8UF+-10% 35VDC TA	25088	D6R8G81835K
A9C3	0160-0576	5	5	CAPACITOR=FXD .1UF +-20% 50VDC CER	28480	0160-0576
A9C4	0160-2617	1	5	CAPACITOR=FXD 6.8UF+-10% 35VDC TA	25088	D6R8G81835K
A9C5	0160-0576	5	5	CAPACITOR=FXD .1UF +-20% 50VDC CER	28480	0160-0576
A9C6	0160-3878	6	3	CAPACITOR=FXD 1000PF +-20% 100VDC CER	28480	0160-3878
A9C7	0160-0576	6	3	CAPACITOR=FXD .1UF +-20% 50VDC CER	28480	0160-0576
A9C8	0160-3878	6	3	CAPACITOR=FXD 1000PF +-20% 100VDC CER	28480	0160-3878
A9C9	05335-80004	2	1	COIL=CAPACITOR	28480	05335-80004
A9C10	0160-0576	5	5	CAPACITOR=FXD .1UF +-20% 50VDC CER	28480	0160-0576
A9C11	0160-0576	5	5	CAPACITOR=FXD .1UF +-20% 50VDC CER	28480	0160-0576
A9C12	0160-2617	1	5	CAPACITOR=FXD 6.8UF+-10% 35VDC TA	25088	D6R8G81835K
A9C13	0160-0576	5	5	CAPACITOR=FXD .1UF +-20% 50VDC CER	28480	0160-0576
A9C14	0160-0576	5	5	CAPACITOR=FXD .1UF +-20% 50VDC CER	28480	0160-0576
A9C15	0160-0576	5	5	CAPACITOR=FXD .1UF +-20% 50VDC CER	28480	0160-0576
A9C16	0160-3878	6	3	CAPACITOR=FXD 1000PF +-20% 100VDC CER	28480	0160-3878
A9C17	0160-0576	6	3	CAPACITOR=FXD .1UF +-20% 50VDC CER	28480	0160-0576
A9C18	0160-0576	6	3	CAPACITOR=FXD .1UF +-20% 50VDC CER	28480	0160-0576
A9C19	0160-3874	2	1	CAPACITOR=FXD 10PF +-5PF 200VDC CER	28480	0160-3874
A9C20	0160-0576	5	5	CAPACITOR=FXD .1UF +-20% 50VDC CER	28480	0160-0576
A9C21	0160-0576	5	5	CAPACITOR=FXD .1UF +-20% 50VDC CER	28480	0160-0576
A9C22	0160-2617	1	5	CAPACITOR=FXD 6.8UF+-10% 35VDC TA	25088	D6R8G81835K
A9C23	0160-0576	5	5	CAPACITOR=FXD .1UF +-20% 50VDC CER	28480	0160-0576
A9C24	0160-2617	1	5	CAPACITOR=FXD 6.8UF+-10% 35VDC TA	25088	D6R8G81835K
A9C25	0160-0576	5	5	CAPACITOR=FXD .1UF +-20% 50VDC CER	28480	0160-0576
A9C26	0160-0576	5	5	CAPACITOR=FXD .1UF +-20% 50VDC CER	28480	0160-0576
A9C27	0160-0576	5	5	CAPACITOR=FXD .1UF +-20% 50VDC CER	28480	0160-0576
A9CR1	1901-0639	4	4	DIODE-PIN 110V	28480	5082-3080
A9CR2	1901-0639	4	4	DIODE-PIN 110V	28480	5082-3080
A9CR3	1901-0639	4	4	DIODE-PIN 110V	28480	5082-3080
A9CR4	1901-0639	4	4	DIODE-PIN 110V	28480	5082-3080
A9CR5†	05335-80005	9	2	DIODE-MATCHED SET OF 2	28480	5082-3080
A9CR6	1901-0050	3	2	DIODE-SWITCHING 80V 200MA 2NS DO-35	28480	1901-0050
A9CR7	1901-0050	3	2	DIODE-SWITCHING 80V 200MA 2NS DO-35	28480	1901-0050
A9CR8	1901-1068	5	4	DIODE-SCHOTTKY	28480	1901-1068
A9CR9	1901-1068	5	4	DIODE-SCHOTTKY	28480	1901-1068
A9CR10	1902-0551	1	2	DIODE-ZNR 6.19V 5% DO-15 PD=1W TC=+.022%	28480	1902-0551
A9CR11	1901-1068	5	4	DIODE-SCHOTTKY	28480	1901-1068
A9CR12	1901-1068	5	4	DIODE-SCHOTTKY	28480	1901-1068
A9CR13	1902-0551	1	2	DIODE-ZNR 6.19V 5% DO-15 PD=1W TC=+.022%	28480	1902-0551
A9CR14†	05335-80005	9	2	DIODE-MATCHED SET OF 2	28480	5082-3080
A9J1	1251-4275	3	1	CONNECTOR 3=PIN M POST TYPE	28480	1251-4275
A9J3	1250-0835	1	1	CONNECTOR=RF 8MC M PC 50-OHM	28480	1250-0835
A9L1	9100-2272	5	3	INDUCTORRF=CH-MLD 47UH 10% .105DX.26LG	28480	9100-2272
A9L2	9100-2256	5	3	INDUCTORRF=CH-MLD 56UH 10% .105DX.26LG	28480	9100-2256
A9L3	9100-2255	4	1	INDUCTORRF=CH-MLD 470NH 10% .105DX.26LG	28480	9100-2255
A9L4	9100-2256	5	3	INDUCTORRF=CH-MLD 56UH 10% .105DX.26LG	28480	9100-2256
A9L5	9100-1788	6	1	CHOKE-WIDE BAND ZMAX=680 OHM @ 180 MHZ	02114	VK200 20/48
A9P1	1854-0345	8	1	TRANSISTOR NPN 2N5179 8I T0=72 PD=200MW	04713	2N5179
A9R1	0698-7211	8	3	RESISTOR 90.9 1% .05W F TC=0+-100	24546	C3-1/8-T0=90R9-G
A9R2	0698-7211	8	3	RESISTOR 90.9 1% .05W F TC=0+-100	24546	C3-1/8-T0=90R9-G
A9R3	0698-7226	7	2	RESISTOR 464 1% .05W F TC=0+-100	24546	C3-1/8-T0=464R-G
A9R4	0698-7222	1	3	RESISTOR 261 1% .05W F TC=0+-100	24546	C3-1/8-T0=261R-G
A9R5	0698-7226	7	2	RESISTOR 464 1% .05W F TC=0+-100	24546	C3-1/8-T0=464R-G
A9R6	0698-7236	7	4	RESISTOR 1K 1% .05W F TC=0+-100	24546	C3-1/8-T0=1001-G
A9R7	0698-7198	0	3	RESISTOR 26.1 1% .05W F TC=0+-100	24546	C3-1/8-T0=26R1-G
A9R8	0698-7216	3	1	RESISTOR 147 1% .05W F TC=0+-100	24546	C3-1/8-T0=147R-G
A9R9	0698-7211	8	3	RESISTOR 90.9 1% .05W F TC=0+-100	24546	C3-1/8-T0=90R9-G
A9R10	0698-7198	0	3	RESISTOR 26.1 1% .05W F TC=0+-100	24546	C3-1/8-T0=26R1-G
A9R11	0698-7259	4	2	RESISTOR 9.09K 1% .05W F TC=0+-100	24546	C3-1/8-T0=9091-G
A9R12	0698-7205	0	1	RESISTOR 51.1 1% .05W F TC=0+-100	24546	C3-1/8-T0=51R1-G
A9R13	0698-7259	4	2	RESISTOR 9.09K 1% .05W F TC=0+-100	24546	C3-1/8-T0=9091-G
A9R14	0698-7233	4	1	RESISTOR 750 1% .05W F TC=0+-100	24546	C3-1/8-T0=750R-G
A9R15	0698-7234	5	1	RESISTOR 825 1% .05W F TC=0+-100	24546	C3-1/8-T0=825R-G
A9R16	0757-0178	8	1	RESISTOR 100 1% .25W F TC=0+-100	24546	C5-1/4-T0=101-F
A9R17	0698-7252	7	1	RESISTOR 4.64K 1% .05W F TC=0+-100	24546	C3-1/8-T0=4641-G
A9R18	0698-7188	8	2	RESISTOR 10 1% .05W F TC=0+-100	24546	C3-1/8-T0=10R-G
A9R19	0698-7188	8	2	RESISTOR 10 1% .05W F TC=0+-100	24546	C3-1/8-T0=10R-G
A9R20	0698-7222	1	3	RESISTOR 261 1% .05W F TC=0+-100	24546	C3-1/8-T0=261R-G

See introduction to this section for ordering information

*Indicates factory selected value

†Set of 2 matched diodes. See paragraph 6-15.

Table 6-5. Option 030 Replaceable Parts (Continued)

Reference Designation	HP Part Number	C D	Qty	Description	Mfr Code	Mfr Part Number
A9R21	0698-7222	1		RESISTOR 261 1% .05W F TC=0+-100	24546	C3-1/8-T0=261R-G
A9R22	2100-178A	9	1	RESISTOR-TRMR 500 10% C TOP=ADJ 1-TRN	73138	82PR500
A9R23	2100-1985	8	2	RESISTOR-TRMR 20 20% C TOP=ADJ 1-TRN	32997	3329M-1=200
A9R24	2100-1985	8		RESISTOR-TRMR 20 20% C TOP=ADJ 1-TRN	32997	3329M-1=200
A9R25	0698-7236	7		RESISTOR 1K 1% .05W F TC=0+-100	24546	C3-1/8-T0=1001-G
A9R26	0698-7236	7		RESISTOR 1K 1% .05W F TC=0+-100	24546	C3-1/8-T0=1001-G
A9R27	0698-7198	9		RESISTOR 26.1 1% .05W F TC=0+-100	24546	C3-1/8-T00=261-G
A9R28	0698-728A	0	1	RESISTOR 147K 1% .05W F TC=0+-100	24546	C3-1/8-T0=1473-G
A9R29	0698-7236	7		RESISTOR 1K 1% .05W F TC=0+-100	24546	C3-1/8-T0=1001-G
A9U1	5088-7036	7	1	1.6 GHZ AMPLIFIER ASSEMBLY	28480	5088-7036
A9U2	1820-2382	6	1	IC DIVP ECL DECD	28480	10C2A
A9U3	1420-1225	4	1	IC FF ECL D=M/8 DUAL	04713	MC10231P
A9U4	1426-0412	1	1	IC COMPARATOR PRCN DUAL 8=DIP=P	27014	LM393N
A9U5	1820-1112	8	1	IC FF TTL LS D=TYPE POS=EDGE=TRIG	01293	SN74LS74AN
A9W1	05335-60105	2	1	CABLE ASSEMBLY=CHANNEL *C= RF	28480	05335-60105
A9W2	05335-60106	3	1	CABLE ASSEMBLY=*C= CHANNEL SENS	28480	05335-60106
A9W3	05335-60109	6	1	CABLE ASSEMBLY=PREAMPL POWER	28480	05335-60109
A9 MISCELLANEOUS PARTS						
	0360-0124	3	6	CONNECTOR-SGL CONT PIN .04-IN=88C-SZ RND	28480	0360-0124
	0590-0038	5	1	NUT-HEX=OBL=CHAM 1/2=32=THD .094-IN=THK	00000	ORDER BY DESCRIPTION
	2110-0301	1	1	FUSE .125A 125V .281X.093	28480	2110-0301
	05305-00010	6	3	CLAMP-GROUNDING	28480	05305-00010
	2190-0068	5	1	WASHER=LK INTL T 1/2 IN .505-IN-ID	28480	2190-0068
	05335-00012	4	2	CLAMP=HEAT SINK	28480	05335-00012
	1251-1556	7	16	CONNECTOR-SGL CONT SKT .018-IN=88C-SZ	28480	1251-1556
	05305-20104	1	1	HOLDER=FUSE	28480	05305-20104
	05305-20105	2	1	INSULATOR	28480	05305-20105
	05305-60205	7	1	CONNECTOR ASSEMBLY=BNC	28480	05305-60205
	05305-60206	8	1	CONNECTOR ASSEMBLY=SVC	28480	05305-60206
	05335-00002	2		PANEL=FRONT (OPTION)	28480	05335-00002
	05335-00008	8	1	PANEL=FREQ *C*	28480	05335-00008

See introduction to this section for ordering information
*Indicates factory selected value

Table 6-6. Manufacturers Code List

MFR. NO.	MANUFACTURER NAME	ADDRESS	ZIP CODE
00000	Any Satisfactory Supplier		
00853	Sangamo Elec. Co. So. Carolina Div.	Pickens, SC	29671
01121	Allen-Bradley Co.	Milwaukee, WI	53204
01295	Texas Instr. Inc. Semicond. Cmpnt. Div.	Dallas, TX	75222
0192B	RCA Corp. Solid State Div.	Somerville, NJ	08876
02111	Spectrol Electronics Corp.	City of Ind., CA	91745
02114	Ferroxcube Corp.	Saugerties, NY	12477
03508	GE Co. Semiconductor Prod. Dept.	Syracuse, NY	13201
03888	KDI Pyrofilm Corp.	Whippany, NJ	07981
04713	Motorola Semiconductor Products	Phoenix, AZ	85062
05245	Corcom Inc.	Chicago, IL	60657
0653A	Etri Inc.	Burr Ridge, IL	60521
06665	Precision Monolithics Inc.	Santa Clara, CA	95050
07263	Fairchild Semiconductor Div.	Mountain View, CA	94042
15818	Teledyne Semiconductor	Mountain View, CA	94043
16299	Corning Gl. Wk. Elec. Cmpnt. Div.	Raleigh, NC	27604
18324	Signetics Corp.	Sunnyvale, CA	94086
19701	Mepco/Electra Corp.	Mineral Wells, TX	76067
23936	Pamotor Div. William J. Purdy	Burlingame, CA	94010
24355	Analog Devices Inc.	Norwood, MA	02062
24546	Corring Glass Works (Bradford)	Bradford, PA	16701
25088	Siemens Corp.	Iselin, NJ	08830
27014	National Semiconductor Corp.	Santa Clara, CA	95051
28480	Hewlett-Packard Co. Corporate Hq.	Palo Alto, CA	94304
32293	Intersil Inc.	Cupertino, CA	95014
32997	Bourns Inc. Trimpot Prod. Div.	Riverside, CA	92507
34335	Advanced Micro Devices Inc.	Sunnyvale, CA	94086
51642	Centre Engineering Inc.	State College, PA	16801
52072	Circuit Assembly Corp.	Costa Mesa, CA	92626
52763	Stettner-Trush Inc.	Cazenovia, NY	13035
55576	Synertek	Santa Clara, CA	95051
56289	Sprague Electric Co.	North Adams, MA	01247
72136	Electro Motive Corp. Sub. IEC	Willimantic, CT	06226
73138	Beckman Instruments Inc. Helipot Div.	Fullerton, CA	92634
75915	Littelfuse Inc.	Des Plaines, IL	60016
8E175	Burr Brown Co.	Huntsville, AL	35801
84411	TRW Capacitor Div.	Ogallala, NE	69153
91637	Dale Electronics Inc.	Columbus, NE	68601
98291	Sealectro Corp.	Mamaroneck, NY	10544

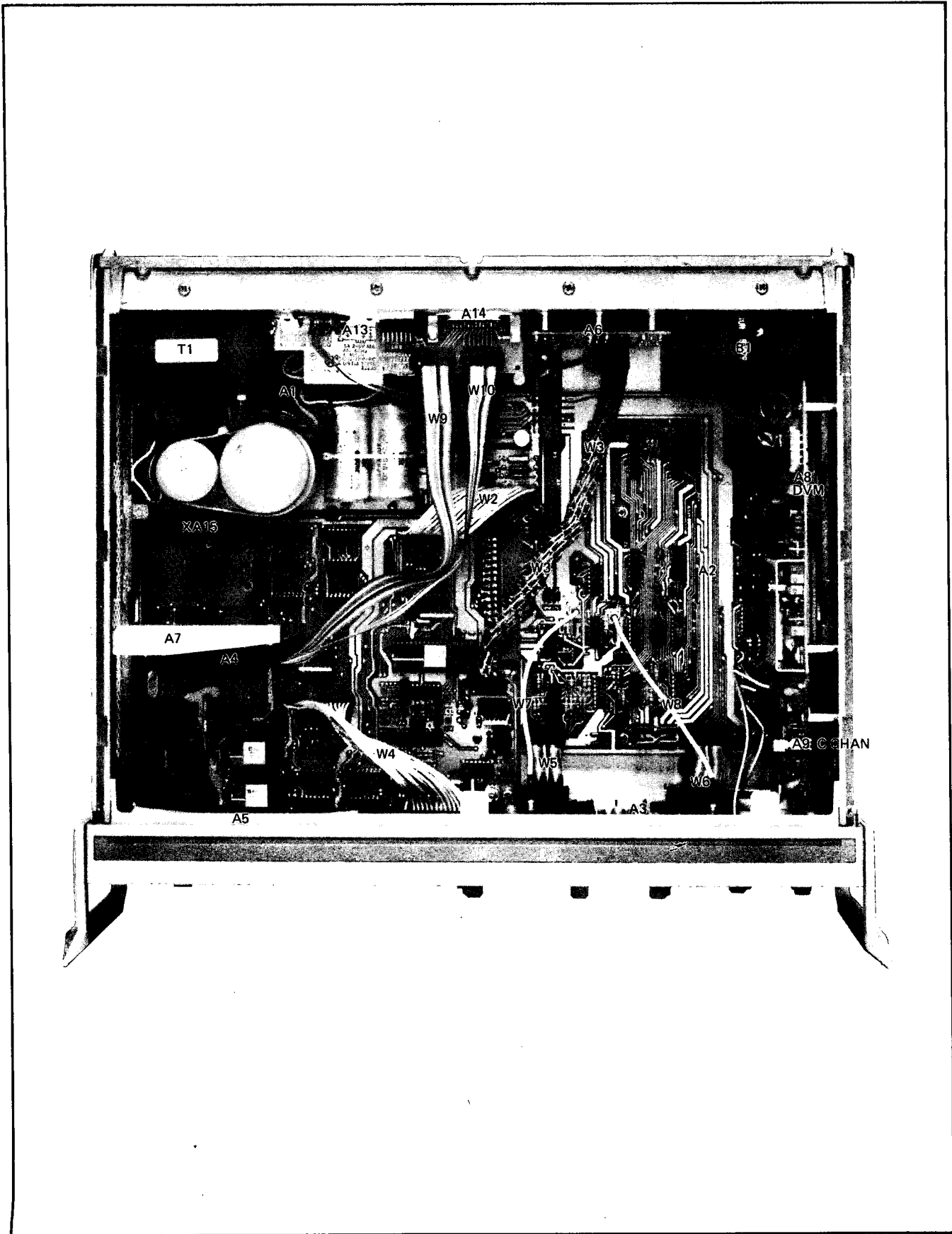

Figure 6-1. Top Internal View

SECTION VII MANUAL CHANGES

7-1. INTRODUCTION

7-2. This section contains information necessary to adapt this manual to apply to older instruments.

7-3. MANUAL CHANGES

7-4. This manual applies directly to Model 5335A Universal Frequency Counters with serial number prefix 2024A.

7-5. As engineering changes are made, newer instruments may have serial prefix numbers higher than 2024A. The manuals for these instruments will be supplied with yellow MANUAL CHANGE sheets, containing the required information. Replace affected pages or modify existing manual information as directed in the MANUAL CHANGE pages. Contact the nearest Hewlett-Packard Sales and Service Office if the change information is missing.

7-6. OLDER INSTRUMENTS

7-7. If your instrument's serial number prefix is lower than 2024A, perform the backdating that applies to your instrument's serial prefix, as listed in *Table 7-1* below.

Table 7-1. Manual Backdating

If Instrument Has Serial Prefix	Make the Following Changes to the Manual
2012A	1
2008A	1,2
1928A	1,2,3

CHANGE 1 (2012A)

Page 6-19, Table 6-2, Miscellaneous Parts:

Add "05335-00005; 5; CD=1; HEAT SYNC; 28480".

Add "5001-0439; 8; CD=2; TRIM, FRONT SIDE; 28480".

Page 6-5, Table 6-2, A1 Replaceable Parts:

Delete "HEAT SYNC; 05335-00005".

Add "A1CR5; 1901-0050; CD=3; DIODE-SWITCHING 80V 200MA 2NS DO-35; 28480".

Delete "A1CR12".

Delete "A1R16; 0757-0421; CD=4; RESISTOR 825 1%; 24546".

Delete "A2R15; 2100-3383; CD=4; RESISTOR-TRMR 50 10%; 28480".

Page 5-2, Paragraph 5-14, step e:

Delete step e.

CHANGE 1 (2012A) (Continued)

Page 8-68, Figure 8-23, A1 Schematic Diagram:

Change A1 series number at top of schematic from "2024" to "2012".
Change the output circuitry for regulator A1U6 as follows:

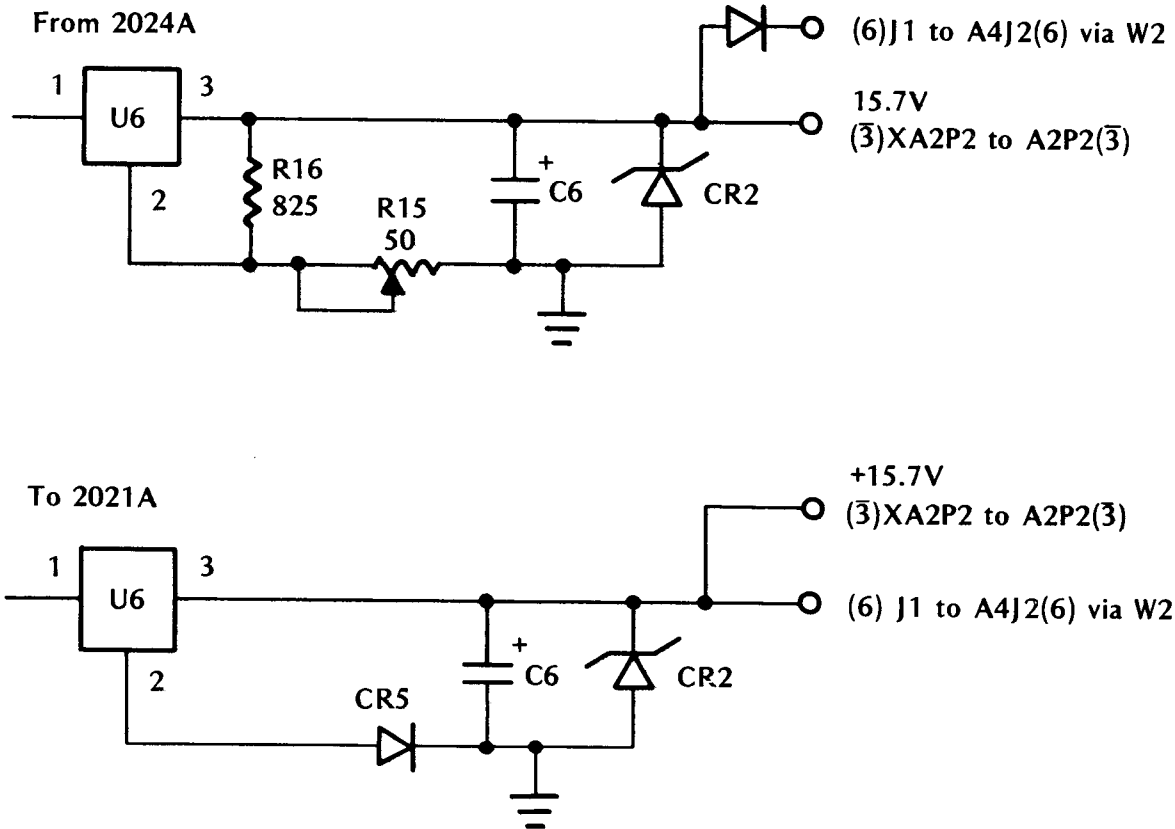

CHANGE 2 (2008A)

Page 6-23, Table 6-5, A9 Replaceable Parts:

Change A9L2 and A9L4 from "9100-2256; INDUCTOR 56UH" to "9100-2272; INDUCTOR 47UH".

Change A9CR5 and A9CR14 from "05335-80005; DIODE-MATCHED SET OF TWO; 28480" to "1901-0535; DIODE-SCHOTTKY; 28480; 1901-0535".

Delete A9C26 and A9C27.

Page 8-84, Figure 8-31, A9 Schematic Diagram:

Change A9 series number at top of schematic from "2012" to "1928".

Change the value of A9L2 and A9L4, in upper left corner, from "0.56U" to "0.47U".

Page 6-9, Table 6-2, A3 Replaceable Parts:

Change A3C23 and A3C37 from "0160-3875; CAPACITOR-FXD 22PF" to "0160-4493; CAPACITOR-FXD 27PF".

Page 8-72, Figure 8-25, A3 Schematic Diagram:

Change the value of A9C23 and A9C37, near "X 10" ATTN, from "22PF" to "27PF".

CHANGE 3 (1928A)

Page 6-18, Table 6-2, A13 Replaceable Parts:

Change A13 LINE MODULE-FILTERED part number from "0960-0448" to "0960-0443".

Page 8-68, Figure 8-23, A1 Schematic Diagram:

Change the part number at the top of the A13 Assembly Schematic from "0960-0448" to "0960-0443".

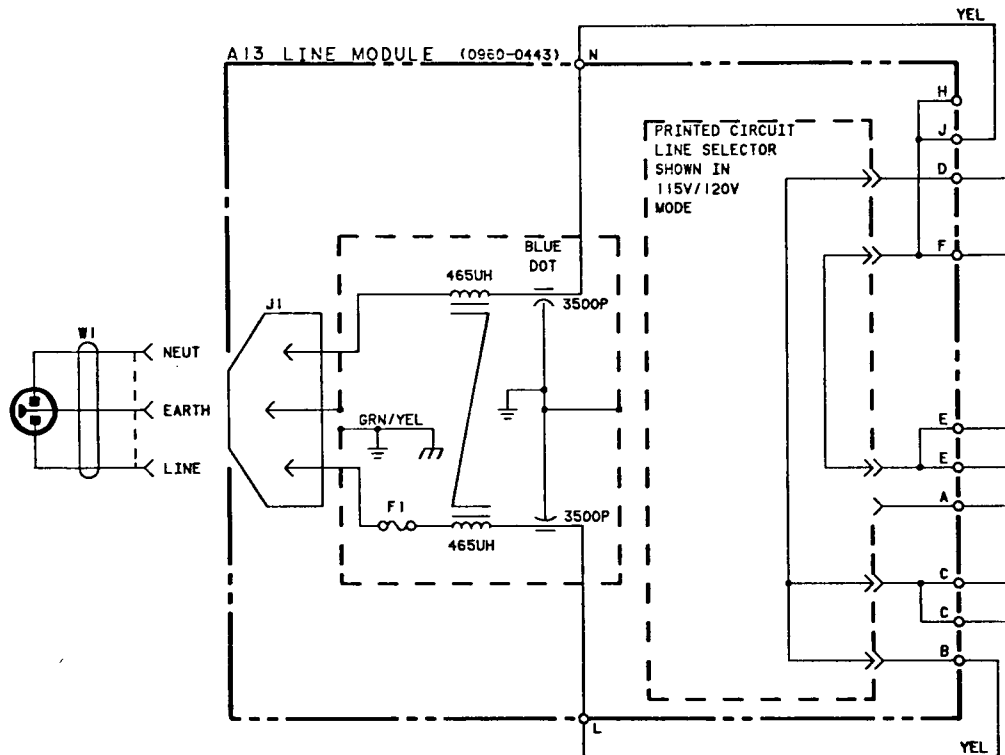

Page 6-8, Table 6-2, A2 Replaceable Parts:

Delete A2R65 and A2R66.

Change A2R47 and A2R50 from "0757-0398; CD=4; RESISTOR 75 1%" to "0757-0401; CD=0; RESISTOR 100 1%".

Page 8-70, Figure 8-24, A2 Schematic Diagram:

Change A2 series number at top of schematic from "2008" to "1928".

Delete A2R65 and A2R66, and connect R47 and R50 to ground.

Change the value of A2R47 and A2R50 from "75" to "100".

```
10 OUTPUT 703 USING "K" : "IN FH  
* 20 WAO CY3 RE  
30 OUTPUT 703 USING "K" : "CO"  
40 PAUSE  
* 50 OUTPUT 703 USING "K" : "CO"  
60 ENTER 703 : A  
70 DISP A  
* 80 END  
29831
```

This works for ϕ or #'s

```
10 OUTPUT 703 USING "K" : "IN FN  
3 WAO CYL RE"  
20 OUTPUT 703 USING "K" : "GO"  
25 PAUSE  
30 OUTPUT 703 USING "K" : "GC"  
40 ENTER 703 ; R  
50 DISP A  
60 END  
2983:
```

*This locks bus
gate does not close*

```
10 OUTPUT 703 USING "K" : "IN FN  
3 WAI CY1 RE"  
20 OUTPUT 703 USING "K" : "GO"  
25 PAUSE  
30 OUTPUT 703 USING "K" : "GC"  
40 ENTER 703 : A  
50 DISP A  
60 END  
29831
```

This locks bus
gate does not close

```
10 OUTPUT 703 USING "K" ; "IN FN  
3 WAL CY3 RE"  
20 OUTPUT 703 USING "K" ; "GO"  
25 PAUSE  
30 OUTPUT 703 USING "K" ; "GC"  
40 ENTER 703 ; A  
50 DISP A  
60 END  
29831
```

This returns ϕ then
counter shows actual
totalize
Shows ϕ while counting

SECTION VIII SERVICE

8-1. INTRODUCTION

8-2. This section provides service information and symbol descriptions, theory of operation, troubleshooting procedures, and schematic diagrams. The arrangement of the content of this section is described in detail below. Refer to the Table of Contents for specific page and paragraph numbers.

- a. SCHEMATIC DIAGRAM SYMBOLS AND REFERENCE DESIGNATIONS. Describes the symbols used on schematic diagrams and reference designators used for parts, sub-assemblies and assemblies.
- b. IDENTIFICATION MARKINGS. Describes the method used by Hewlett-Packard for identifying printed-circuit boards and assemblies.
- c. SAFETY CONSIDERATIONS. Describes the safety considerations applicable during maintenance, adjustments, and repair.
- d. SAFETY SYMBOLS. Lists and describes the safety symbols used on equipment and in manuals.
- e. RECOMMENDED TEST EQUIPMENT. Refers to test equipment specified in *Table 1-4*.
- f. SERVICE AIDS. Notes information provided to assist service personnel.
- g. FACTORY SELECTED COMPONENTS. Lists procedures for replacement of parts whose values are selected at time of manufacture for optimum performance.
- h. LOGIC SYMBOLS. Description of logic symbols used on schematics.
- i. THEORY OF OPERATION. Presents the theory of operation for the 5335A in two levels.
 1. First, the Overall Counter Operation is described using the simplified block diagram in *Figure 8-10*. This discussion introduces the major functional circuits and briefly explains their purpose and operation during normal measurements.
 2. Second, the Block Diagram Description gives an in-depth explanation of each assembly; its function and operation with respect to measurement cycles. These paragraphs reference the detailed block diagram in *Figure 8-2*. Included in this discussion are descriptions of the multiple-register-counter (MRC), the microprocessor system, principles of the Interpolating technique, and the use of "peak-detectors" for triggering modes.
- j. TROUBLESHOOTING. Provides the troubleshooting information for the HP5335A in the following forms:
 1. DIAGNOSTICS, which are built-in to the instrument, are used in a sequence illustrated in Block Diagrams. They serve to verify, by self-check, various functional sub-sections of the counter's circuitry. They can be selectively activated, in isolated loops, to allow on-line testing.
 2. SIGNATURE ANALYSIS, which when integrated with the specified diagnostic routines, allows on-circuit troubleshooting to component level. All instructions, signatures, and physical Test-Points are provided.
 3. SCHEMATIC DIAGRAMS, for all assemblies are provided at the end of this section. They are arranged in numerical order according to the assembly number (i.e., A9, A10, A11, etc.) in *Figures 8-23 through 8-32*.

8-3. SCHEMATIC DIAGRAM SYMBOLS AND REFERENCE DESIGNATORS

8-4. *Figure 8-1* shows the symbols used on the schematic diagrams. At the bottom of *Figure 8-1*, the system for reference designators, assemblies, and subassemblies is shown.

8-5. Reference Designations

8-6. Assemblies such as printed-circuits are assigned numbers in sequence, A1, A2, etc. As shown in *Figure 8-1*, subassemblies within an assembly are given a subordinate A number. For example, rectifier subassembly A1 has the complete designator of A25A1. For individual components, the complete designator is determined by adding the assembly number and subassembly number if any. For example, CR1 on the rectifier assembly is designated A25A1CR1.

8-7. IDENTIFICATION MARKINGS ON PRINTED-CIRCUIT BOARDS

8-8. HP printed-circuit boards (see *Figure 8-1*) have four identification numbers: an assembly part number, a series number, a revision letter, and a production code.

8-9. The assembly part number has 10 digits (such as 05335-60001) and is the primary identification. All assemblies with the same part number are interchangeable. When a production change is made on an assembly that makes it incompatible with previous assemblies, a change in part number is required. The series number (such as 1936A) is used to document minor electrical changes. As changes are made, the series number is incremented. When replacement boards are ordered, you may receive a replacement with a different series number. If there is a difference between the series number marked on the board and the schematic in this manual, a minor electrical difference exists. If the number on the printed-circuit board is lower than that on the schematic, refer to Section VII for backdating information. If it is higher, refer to the looseleaf manual change sheets for this manual. If the manual change sheets are missing, contact your local Hewlett-Packard Sales and Service Office. See the listing on the back cover of this manual.

8-10. Revision letters (A, B, etc.) denote changes in printed-circuit layout. For example, if a capacitor type is changed (electrical value may remain the same) and requires different spacing for its leads, the printed-circuit board layout is changed and the revision letter is incremented to the next letter. When a revision letter changes the series number is also usually changed. The production code is the four-digit seven-segment number used for production purposes.

8-11. Assembly Identification

8-12. The assembly number, name, and Hewlett-Packard part number of 5335A assemblies are listed in *Table 8-1*.

Table 8-1. Assembly Identification

ASSEMBLY	NAME	HP PART NO.
A1	POWER SUPPLY ASSEMBLY	05335-60001
A2	AMPLIFIER SUPPORT ASSEMBLY	05335-60002
A3	AMPLIFIER BUFFER ASSEMBLY	05335-60003
A4	MAIN LOGIC ASSEMBLY	05335-60004
A5	KEYBOARD AND DISPLAY ASSEMBLY	05335-60005
A6	REAR PANEL ASSEMBLY	05335-60006
A7	HP-IB LOGIC ASSEMBLY	05335-60007
A8	DVM ASSEMBLY	05335-60008
A9	C CHANNEL ASSEMBLY	05335-60009
A10	NOT ASSIGNED	
A11	NOT ASSIGNED	
A12	NOT ASSIGNED	
A13	LINE MODULE ASSEMBLY	0960-0448
A14	HP-IB CONNECTOR	05370-60005
A15	10 MHz OVEN OSCILLATOR ASSEMBLY	HP10811A or HP10544A

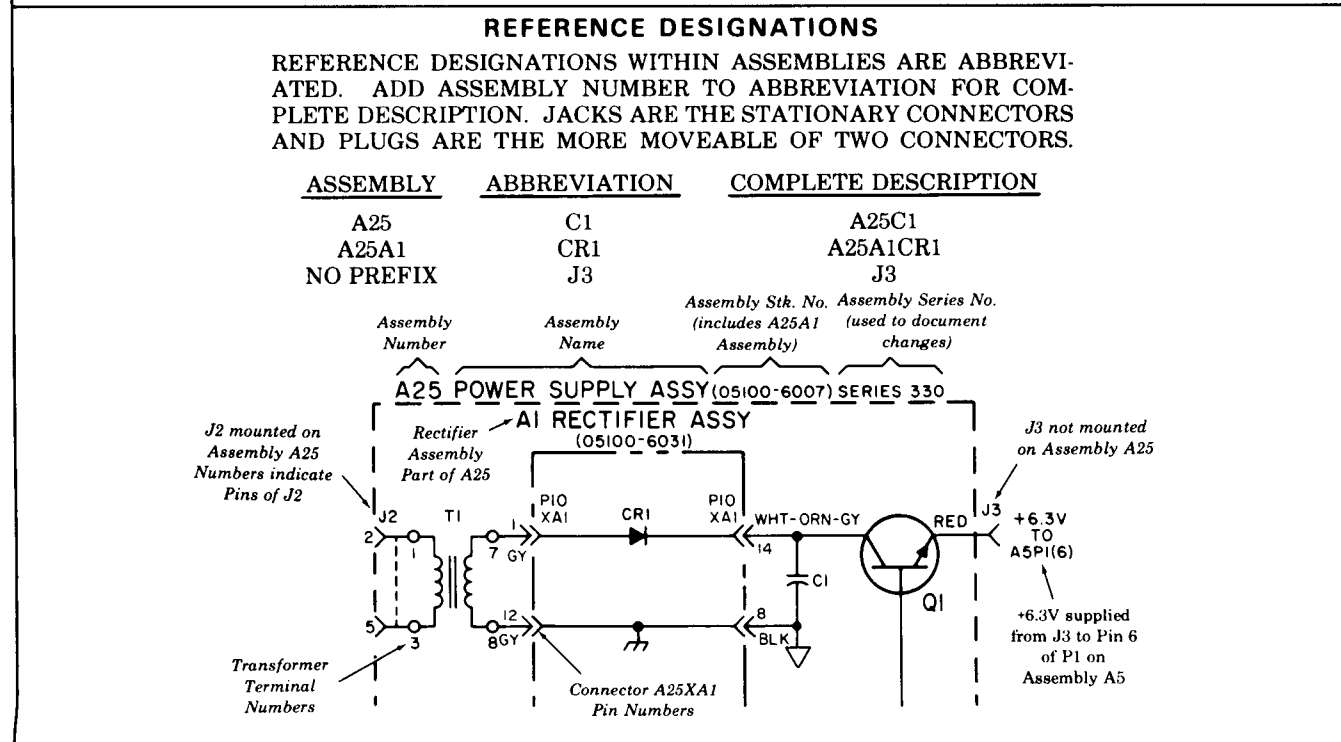
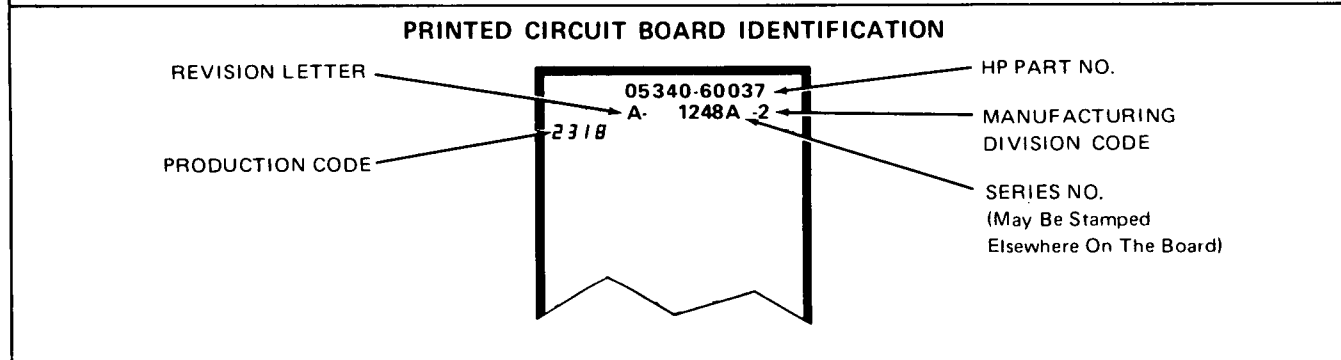
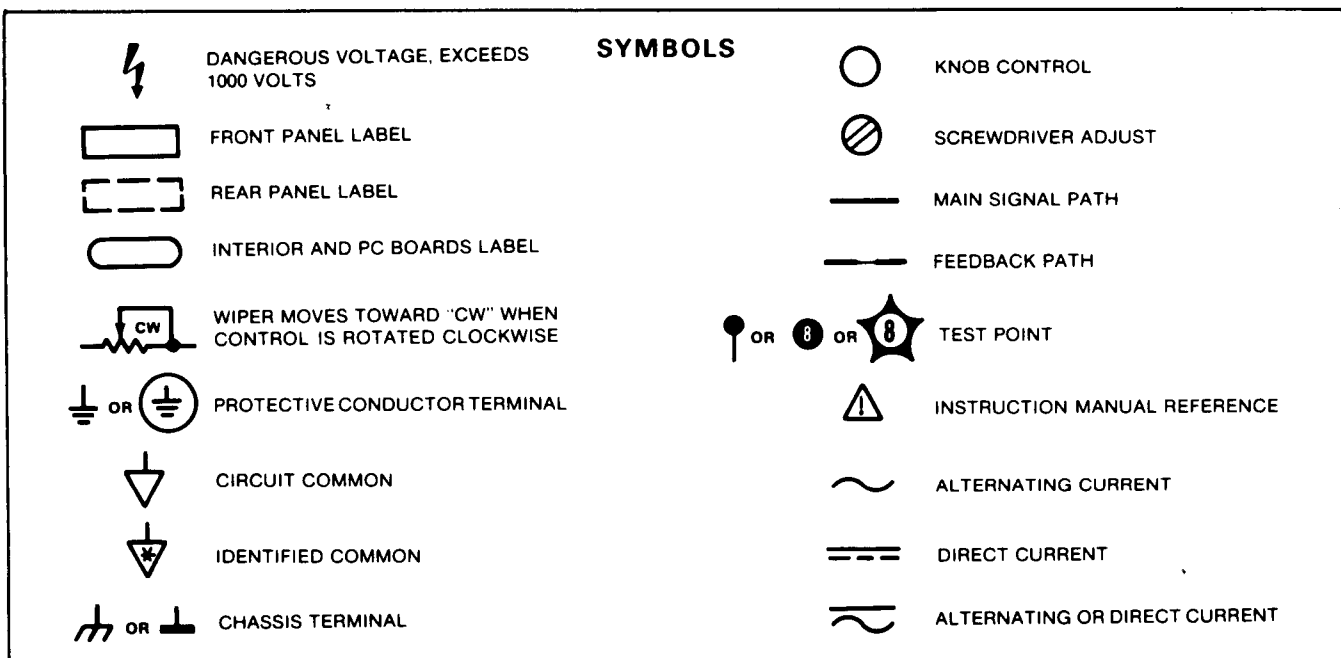

Figure 8-1. Schematic Diagram Notes

8-13. SAFETY CONSIDERATIONS

8-14. Although this instrument has been designed in accordance with international safety standards, this manual contains information, cautions, and warnings which must be followed to ensure safe operation and to retain the instrument in safe condition. Service and adjustments should be performed only by service-trained personnel.

WARNING

ALL PROTECTIVE EARTH TERMINALS, EXTENSION CORDS, AUTOTRANSFORMERS AND DEVICES CONNECTED TO THE INSTRUMENT SHOULD BE CONNECTED TO A PROTECTIVE EARTH GROUNDED SOCKET. ANY INTERRUPTION OF THE PROTECTIVE EARTH GROUNDING WILL CAUSE A POTENTIAL SHOCK HAZARD THAT COULD RESULT IN PERSONAL INJURY.

ONLY THE 250V FUSES WITH THE REQUIRED RATED CURRENT AND SPECIFIED TYPE SHOULD BE USED. DO NOT USE REPAIRED FUSES OR SHORT CIRCUITED FUSEHOLDERS. TO DO SO COULD CAUSE A SHOCK OR FIRE HAZARD.

8-15. Any adjustment, maintenance, and repair of the opened instrument under voltage should be avoided as much as possible and, when inevitable, should be carried out only by a skilled person who is aware of the hazard involved.

8-16. Capacitors inside the instrument may still be charged even if the instrument has been disconnected from its source of power.

WARNING

POWER IS ALWAYS PRESENT AT THE LINE SWITCH AND TRANSFORMER, AND UNREGULATED DC IS PRESENT WHENEVER THE LINE CORD IS ATTACHED. UNPLUGGING THE POWER CORD IS NECESSARY TO REMOVE ALL POWER FROM THE INSTRUMENT.

8-17. Make sure that only fuses with the required rated current and of the specified type (normal blow, time delay, etc.) are used for replacement. The use of repaired fuses and the short-circuiting of fuseholders must be avoided. Whenever it is likely that this protection has been impaired, the 5335A must be made inoperative and be secured against any unintended operation.

WARNING

THE SERVICE INFORMATION IS OFTEN USED WITH POWER SUPPLIED AND PROTECTIVE COVERS REMOVED FROM THE 5335A. ENERGY AVAILABLE AT MANY POINTS MAY, IF CONTACTED, RESULT IN PERSONAL INJURY.

CAUTION

Series pass transistor cases on rear panel have voltage on them and require insulators between them and the heatsink. Power supply damage is inevitable if transistor cases are shorted to the chassis.

8-18. Safety Symbols

8-19. The following safety symbols are used on equipment and in manuals:



Instruction manual symbol. The product will be marked with this symbol when it is necessary for the user to refer to the instruction manual in order to protect against damage to the instrument.



Indicates dangerous voltage (terminals fed from the interior by voltage exceeding 1000 volts must be so marked).

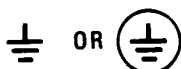

Protective conductor terminal. For protection against electrical shock in case of a fault. Used with field wiring terminals to indicate the terminal which must be connected to ground before operating equipment.



Low-noise or noiseless, clean ground (earth) terminal. Used for a signal common, as well as providing protection against electrical shock in case of a fault. A terminal marked with the symbol must be connected to ground in the manner described in the installation (operating) manual, and before operating the equipment.



Frame and chassis terminal. A connection to the frame (chassis) of the equipment which normally includes all exposed metal structures.



Alternating current (power line).



Direct current (power line).



Alternating or direct current (power line).



The WARNING signal denotes a hazard. It calls attention to a procedure, practice, or the like, which, if not correctly performed or adhered to, could result in personal injury.



The CAUTION sign denotes a hazard. It calls attention to an operating procedure, practice, or the like, which is not correctly performed or adhered to, could result in damage to or destruction of part all of the product.

8-20. RECOMMENDED TEST EQUIPMENT

8-21. Test equipment and test equipment accessories required to maintain the 5335A are listed in *Table 1-4*. Equipment other than that listed may be used if it meets the listed critical specifications.

8-22. SERVICE AIDS

8-23. Pozidriv Screwdrivers

8-24. Many screws in the 5335A appear to be Phillips, but are not. To avoid damage to the screw slots, Pozidriv screwdrivers should be used.

8-25. Service Aids on Printed Circuit Boards

8-26. The servicing aids include test points, transistor and integrated circuit designations, adjustment callouts, and assembly stock numbers.

8-27. FACTORY SELECTED COMPONENTS

8-28. Some component values are selected at the time of final checkout at the factory. These values are selected to provide optimum compatibility with associated components and are identified on schematics and parts lists by an asterisk (*). The recommended procedure for replacing a factory-selected part is as follows:

- a. Refer to paragraphs 8-29 through 8-36 for test procedures required for selection of critical value parts.
- b. For factory selected components that are not listed in paragraphs 8-29 through 8-36, use the original value.
- c. After replacing parts, perform the test specified for the circuit in the performance and adjustment sections of this manual to verify correct operation.

8-29. Procedure To Select R7, R8, R80 Or R81 On Amplifier Buffer Assembly, A3

8-30. This procedure should be performed when any active component in the Peak Detector circuits has been changed, or if it is suspected that the Peak Detectors are not operating properly. Refer to Troubleshooting information in this section for Peak Detector Test.

8-31. These resistors are located in the A Channel and B Channel Peak Detector Circuits of the Amplifier Buffer Assembly, A3. R7 and R8 are in the B Channel Peak Detector. R80 and R81 are in the A Channel Peak Detector.

8-32. Before selecting A3R7, A3R8, A3R80 or A3R81, set up the test equipment as follows:

CONNECT: the 3325A (Function Generator) to the 5335A CHANNEL A INPUT.

SET: 3325A FREQUENCY to 200 Hz square wave
3325A AMPLITUDE to 500 mV p-p

CONNECT: the 3465A (Digital Multimeter) as indicated in Table 8-2.

Set the 5335A front panel controls as follows:

INPUT (CHANNELS A and B)
1 Meg/50 ohm 50 ohm
AC/DC DC (OUT)
ATTN X1 (OUT)
FUNCTION FREQ A
AUTO TRIG ON (IN)
COM A ON (IN)

Table 8-2. Selecting R7, R8, R80 or R81

RESISTOR	VOLTAGE RANGE (mV)	EQUIPMENT SETUP		
		DIGITAL MULTIMETER CONNECTION (V)	(COM)	5335A INPUT A AND B TRIGGER LEVEL POT (PRESET)
R7	+220 to +270	A3R38	GND	MAX. POSITIVE (fully CW)
R8	-220 to -270*	A3R38	GND	MAX. NEGATIVE (fully CCW and out of PRESET)
R80	+220 to +270	A3R54	GND	MAX. POSITIVE (fully CW)
R81	-220 to -270*	A3R54	GND	MAX. NEGATIVE (fully CCW and out of PRESET)

***NOTE**

The 3465A should display a reading of -220 mV to -270 mV. If the voltage is less than -220 mV (i.e. -210 mV), increase the resistance, as described in paragraph 8-33, steps a and b. If the voltage is greater than -270 mV (i.e. -280 mV), decrease the resistance, as described in paragraph 8-33 steps a and b.

- 8-33. After connecting the test equipment as described in paragraph 8-32, proceed as follows:
- a. When selecting the optimum value for A3R7, A3R8, A3R80, or A3R81 use a 1%, .05W resistor (NOMINAL VALUE is 147K). The following are the values and HP part numbers for resistors which may be used.

Value	HP Part No.
75K	0698-8615
100K	0698-7284
147K*	0698-7288
OPEN	—

*NOMINAL VALUE

- b. Select the nominal value, 147K. Measure the voltage at the test point described in *Table 8-2* for each selected resistor, (Digital Multimeter Connection). Refer to *Table 8-2*. If the voltage is less than specified, increase the resistance by removing the resistor (A3R7, A3R8, A3R80 or A3R81), and leaving the circuit open ($\infty \Omega$). If the voltage is greater than specified, decrease the resistance first to 100K, and if necessary to 75K.

NOTE

If one of the four values listed does NOT bring the voltage within the specified range, DO NOT SELECT ANY OTHER VALUE. Proceed as described in steps c through e.

- c. The circuit that contains each factory selected resistor has a set of matched diodes, and a set of matched capacitors. The matched sets for each circuit are:

Resistor	Peak Detector	Diodes	Capacitors
R7	B Channel, Positive	CR1, CR4, CR5	C4, C7
R8	B Channel, Negative	CR2, CR6, CR7	C5, C8
R80	A Channel, Positive	CR24, CR25, CR28	C51, C52
R81	A Channel, Negative	CR26, CR27, CR29	C53, C57

- d. Measure the forward voltage drop across each diode of the matched set in the circuit for the resistor you are selecting. The voltage drop across each diode should match within less than 5 mV of each other.

If the voltages do not match within 5 mV, replace all three diodes in the set (order part number 05335-80003 for set of four matched diodes). If the voltages match, or if replacing the diodes does not correct the problem, then proceed to the next step.

- e. Check the matched capacitors in the circuit containing the resistor to be selected. Verify that both capacitors in the set are .47 μf at 1% tolerance. If they are not within the value specified, replace both capacitors. (Order part number 0160-4931 for matched set of 2 capacitors.)

8-34. Procedure To Select A3R83 On The Amplifier Buffer Assembly

SELECTED VALUES	from 1.21K to 15K
NOMINAL VALUES	2.7K

- a. Connect the SIGNAL OUT from the function generator (HP 3325A) to the 5335A Channel A INPUT, and to the B INPUT on the oscilloscope (HP 1725A).
- b. Connect the A PROBE from the oscilloscope to resistor R39 on the A2 assembly (A2R39), between R39 and the anode of CR7.
- c. Set the 3325A (function generator):
 - FREQUENCY 1 kHz sine wave
 - AMPLITUDE 100 mV p-p
 - DC OFFSET 0
- d. Set the 1725A (oscilloscope):
 - DISPLAY X-Y FUNCTION
 - CHANNEL A VOLTS/DIV to .05
 - CHANNEL A INPUT 1M ohm, DC
 - CHANNEL B VOLTS/DIV to .01
 - CHANNEL B INPUT 50 ohm, DC
- e. Set the 5335A:
 - FUNCTION TIME A → B
 - COM A OFF (OUT)
 - AUTO TRIG OFF (OUT)
 - EXT ARM ENABLE OFF
 - INPUT (Channels A and B)
 - 1M/50 ohm 1M (OUT)
 - AC/DC DC (OUT)
 - X10 ATTN OFF (OUT)
 - TRIGGER LEVELS PRESET (fully CCW)
- f. Set the oscilloscope for the X-Y mode, and calibrate by centering the dot at center screen.
- g. Adjust A3R96 (offset) to position the waveform at the center of the scope screen. Adjust A3R88 (hysteresis) for 18 to 20 mV p-p on the X-axis.
- h. If the waveform is less than 18 mV p-p, then decrease the value of A3R83. If the waveform is greater than 20 mV p-p, increase the value of A3R29.

8-35. Procedure To Select A3R29 On The Amplifier Buffer Assembly

- a. Connect the SIGNAL OUT from the function generator (HP 3325A) to the 5335A Channel B INPUT, and to the B INPUT on the oscilloscope (HP 1725A).
- b. Connect the A PROBE from the oscilloscope to register R33 on the A2 assembly (A2R33), between R33 and the anode of CR6.
- c. Set the test equipment as described in the procedure to select A3R83, (Paragraph 8-34 steps c through e).
- d. Set the oscilloscope for the X-Y mode, and calibrate by centering the dot at center screen.
- e. Adjust A3R47 (offset) to position the waveform at the center of the scope screen. Adjust A3R37 (hysteresis) for 18 to 20 mV p-p on the X-axis.
- f. If the waveform is less than 18 mV p-p, then decrease the value of A3R29. If the waveform is greater than 20 mV p-p, increase the value of A3R29.

8-36. Procedure To Select The X10 Compensating Capacitors A3C37 And A3C23

- a. Connect the 8640B Signal Generator RF output to 5335A input A as shown:

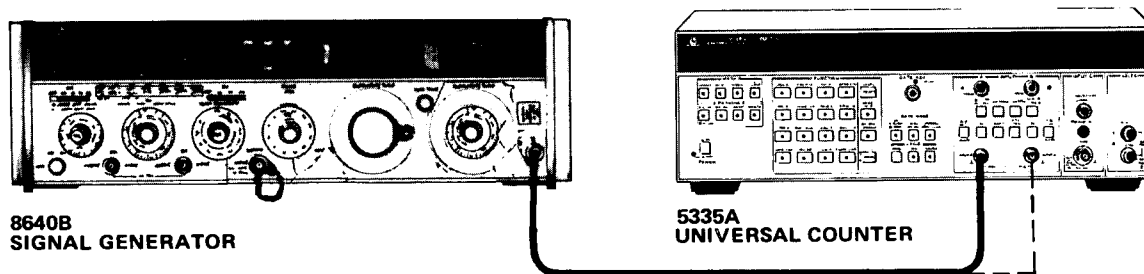

- b. Set 5335A front panel controls as follows:

FUNCTION FREQ A
 GATE MODE NORM
 CYCLE NORM
 INPUT (CHANNELS A and B)
 1 M/50 ohm 50 ohm
 TRIGGER LEVEL PRESET
 X10/X1 ATTEN X1
 AC/DC DC
 COM A OUT
 AUTO TRIG OUT

- c. Set the 8640B to output a 10 MHz signal at 25 mV rms. Verify that the 5335A counter displays the frequency output of the signal generator.
- d. Reduce the signal level slowly until the 5335A stops giving the correct reading; record this level (minimum sensitivity).
- e. Set the generator to output a 100 MHz at 25 mV rms and repeat step d. Do the same at 200 MHz. Record all readings.
- f. Set Channel A attenuator to X10 and repeat steps c through e above, adjusting the signal generator output.
- g. Take the ratio of the readings of minimum sensitivity of X10 to X1 at 10 MHz, 100 MHz and 200 MHz. If the ratio is greater than 14, use the 18 pf capacitor (P/N 0160-4492); if the ratio is less than 6, use the 27 pf capacitor (P/N 0160-4493). This is summarized in the following table.

Ratio	Capacitor Value, PF	HP P/N
>14	18	0160-4492
<6	27	0160-4493

Nominal value for A3C37 and C23: 22 pf, P/N 0160-3875.

- h. Repeat steps c through g to verify that the ratio is between 7 and 13. If it is outside this range, then a problem exists elsewhere.
- i. Connect the signal generator to the 5335A Input B; set the 8640B to output a 10 MHz signal at 25 mV rms. Set 5335A to frequency B by pressing SCALE, SMOOTH, 1, 7, ENTER; verify the 5335A displays the frequency of the generator.
- j. Repeat steps d through h, checking the ratio at 10 MHz, 50 MHz and at 100 MHz.

8-37. LOGIC SYMBOLS

8-38. Logic symbols used in this manual conform to the American National Standard ANSI Y32.14-1973 (IEEE Std. 91-1973). This standard supersedes MIL-STD-806B. In the following paragraphs logic symbols are described. For further descriptions refer to HP Logic Symbology manual, part number 5951-6116.

8-39. Logic Concepts

8-40. The binary numbers 1 and 0 are used in pure logic where 1 represents true, yes, or active and 0 represents false, no, inactive. These terms should not be confused with the physical quantity (e.g., voltage) that may be used to implement the logic, nor should the term "active" be confused with a level that turns a device on or off. A truth table for a relationship in logic shows (implicitly or explicitly) all the combinations of true and false input conditions and the result (output). There are only two basic logic relationships, AND and OR. The following illustrations assume two inputs (A and B), but these can be generalized to apply to more than two inputs.

AND Y is true if and only if A is true and B is true (or more generally, if all inputs are true).
Y=1 if and only if A=1 and B=1
Y=A•B

OR Y is true if and only if A is true or B is true (or more generally, if one or more input(s) is (are) true).
Y=1 if and only if A=1 or B=1
Y=A+B

TRUTH TABLE

A	B	Y
1	1	1
1	0	0
0	1	0
0	0	0

EQUIVALENT SYMBOLS

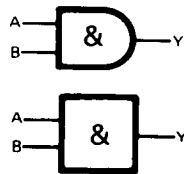

TRUTH TABLE

A	B	Y
1	1	1
1	0	1
0	1	1
0	0	0

EQUIVALENT SYMBOLS

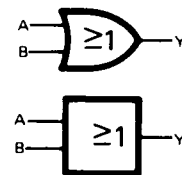

8-41. Negation

8-42. In logic symbology, the presence of the negation indication symbol \circ provides for the presentation of logic function inputs and outputs in terms *independent* of their physical values, the 0-state of the input or output being the 1-state of the symbol referred to the symbol description.

EXAMPLE 1



TRUTH TABLE

A	B	Z
1	1	0
1	0	1
0	1	1
0	0	1

EXAMPLE 2



TRUTH TABLE

A	B	Z
1	1	0
1	0	1
0	1	1
0	0	1

EXAMPLE 3



TRUTH TABLE

A	B	Z
1	1	0
1	0	0
0	1	0
0	0	1

EXAMPLE 4



TRUTH TABLE

A	B	Z
1	1	0
1	0	0
0	1	0
0	0	1

EXAMPLE 1 says that Z is *not* true if A is true *and* B is true or that Z is true if A *and* B are *not* both true. $\overline{Z}=AB$ or $Z=\overline{AB}$. This is frequently referred to as NAND (for NOT AND).

EXAMPLE 2 says that Z is true if A is *not* true or if B is *not* true. $Z=\overline{A+B}$. Note that this truth table is identical to that of Example 1. The logic equation is merely a DeMorgan's transformation of the equations in Example 1. The symbols are equivalent.

EXAMPLE 3 $\overline{Z}=A+B$ or $Z=\overline{A+B}$ and,

EXAMPLE 4 $Z=\overline{A \cdot B}$, also share common truth table and are equivalent transformations of each other. The NOT OR form (Example 3) is frequently referred to as NOR.

NOTE

In this manual the logic negation symbol is NOT used.

8-43. Logic Implementation and Polarity Indication

8-44. Devices that can perform the basic logic functions, AND and OR, are called gates. Any device that can perform one of these functions can also be used to perform the other if the relationship of the input and output voltage levels to the logic variables 1 and 0 is redefined suitably.

8-45. In describing the operation of electronic logic devices, the symbol H is used to represent a "high level", which is a voltage within the more-positive (less-negative) of the two ranges of voltages used to represent the binary variables. L is used to represent a "low level", which is a voltage within the less-positive (more-negative) range.

8-46. A function table for a device shows (implicitly or explicitly) all the combinations of input conditions and the resulting output conditions.

8-47. In graphic symbols, inputs or outputs that are active when at the high level are shown without polarity indication. The polarity indicator symbol \triangleleft denotes that the active (one) state of an input or output *with respect to the symbol to which it is attached* is the low level.

NOTE

The polarity indicator symbol " \triangleleft " is used in this manual.

EXAMPLE 5 assume two devices having the following function tables.

**DEVICE #1
FUNCTION TABLE**

A	B	Y
H	H	H
H	L	L
L	H	L
L	L	L

**DEVICE #2
FUNCTION TABLE**

A	B	Y
H	H	H
H	L	H
L	H	H
L	L	L

POSITIVE
LOGIC

by assigning the relationship H=1, L=0 at both input and output, Device #1 can perform the AND function and Device #2 can perform the OR function. Such a consistent assignment is referred to as positive logic. The corresponding logic symbols would be:

DEVICE #1



DEVICE #2



NEGATIVE LOGIC alternatively, by assigning the relationship $H=0, L=1$ at both input and output, Device #1 can perform the OR function and Device #2 can perform the AND function. Such a consistent assignment is referred to as negative logic. The corresponding logic symbols would be:



8-48. MIXED LOGIC. The use of the polarity indicator symbol (\blacktriangledown) automatically invokes a mixed-logic convention. That is, positive logic is used at the inputs and outputs that do not have polarity indicators, negative logic is used at the inputs and outputs that have polarity indicators.

**EXAMPLE 6
FUNCTION TABLE**

A	B	Z
H	H	L
H	L	H
L	H	H
L	L	H

**EXAMPLE 7
FUNCTION TABLE**

A	B	Z
H	H	L
H	L	L
L	H	L
L	L	H

This may be shown either of two ways:



Note the equivalence of these symbols to examples 1 and 2 and the fact that the function table is a positive-logic translation ($H=1, L=0$) of the NAND truth table, and also note that the function table is the negative-logic translation ($H=0, L=1$) of the NOR truth table, given in Example 3.

This may be shown either of two ways:

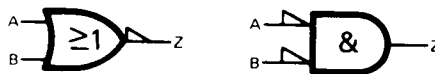

Note the equivalence of these symbols to examples 3 and 4 and the fact that the function table is a positive-logic translation ($H=1, L=0$) of the NOR truth table, and also note that the function table is the negative-logic translation ($H=0, L=1$) of the the NAND truth table, given in Example 1.

8-49. It should be noted that one can easily convert from the symbology of positive-logic merely by substituting a polarity indicator (\blacktriangledown) for each negative indicator (\bullet) while leaving the distinctive shape alone. To convert from the symbology of negative-logic, a polarity indication (\blacktriangledown) is substituted for each negation indicator (\bullet) and the OR shape is substituted for the AND shape or vice versa.

8-50. It was shown that any device that can perform OR logic can also perform AND logic and vice versa. DeMorgan's transformation is illustrated in Example 1 through 7. The rules of the transformation are:

1. At each input or output having a negation (\bullet) or polarity (\blacktriangledown) indicator, delete the indicator.
2. At each input or output not having an indicator, add a negation (\bullet) or polarity (\blacktriangledown) indicator.
3. Substitute the AND symbol \square for the OR symbol \cup or vice versa.

These steps do not alter the assumed convention; positive-logic stays positive, negative-logic stays negative, and mixed-logic stays mixed.

8-51. The choice of symbol may be influenced by these considerations: (1) The operation being performed may best be understood as AND or OR. (2) In a function more complex than a basic gate, the inputs will usually be considered as inherently active high or active low (e.g., the J and K inputs of a J-K flip-flop are active high and active low, respectively). (3) In a chain of logic, understanding and the writing of logic equations are often facilitated if active low or negated outputs feed into active low or negated inputs.

8-52. Other Symbols

8-53. Additional symbols are required to depict complex logic diagrams, as follows:



Dynamic input activated by transition from a low level to a high level. The opposite transition has no effect at the output.



Dynamic input activated by transition from a high level to a low level. The opposite transition has no effect at the output.

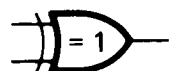

Exclusive OR function. The output will assume its indicated active level if and only if one and only one of the two inputs assumes its indicated active level.

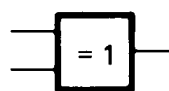

Inverting function. The output is low if the input is high and it is high if the input is low. The two symbols shown are equivalent.



Noninverting function. The output is high if the input is high and it is low if the input is low. The two symbols shown are equivalent.



OUTPUT DELAY. The output signal is effective when the input signal returns to its opposite state.

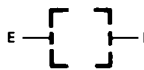

EXTENDER. Indicates when a logic function increases (extends) the number of inputs to another logic function.



FLIP-FLOP. A binary sequential element with two stable states: a set (1) state and a reset (\emptyset) state. Outputs are shown in the 1 state when the flip-flop is set. In the reset state the outputs will be opposite to the set state.



RESET. A 1 input will reset the flip-flop. A return to \emptyset will cause no further effect.



SET. A 1 input will set the flip-flop. A return to \emptyset will cause no further action.



TOGGLE. A 1 input will cause the flip-flop to change state. A return to 0 will cause no further action.



J INPUT. Similar to the S input except if both J and K (see below) are at 1, the flip-flop changes state.



K INPUT. Similar to the R input (see above).



D INPUT (Data). Always dependent on another input (usually C). When the C and D inputs are at 1, the flip-flop will be set. When the C is 1 and the D is 0, the flip-flop will reset.



Address symbol has multiplexing relationship at inputs and demultiplexing relationship at outputs.

8-54. Dependency Notation "C" "G" "V" "F"

8-55. Dependency notation is a way to simplify symbols for complex IC elements by defining the existence of an AND relationship between inputs, or by the AND conditioning of an output by an input without actually showing all the elements and interconnections involved. The following examples use the letter "C" for control and "G" for gate. The dependent input is labeled with a number that is either prefixed (e.g., 1X) or subscripted (e.g., X₁). They both mean the same thing. The letter "V" is used to indicate an OR relationship between inputs or between inputs and outputs with this letter (V). The letter "F" indicates a connect-disconnect relationship. If the "F" (free dependency) inputs or outputs are active (1) the other usual normal conditions apply. If one or more of the "F" inputs are inactive (0), the related "F" output is disconnected from its normal output condition (it floats).



The input that controls or gates other inputs is labeled with a "C" or a "G", followed by an identifying number. The controlled or gated input or output is labeled with the same number. In this example, "1" is controlled by "G1."

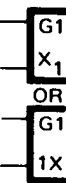

When the controlled or gated input or output already has a functional label (X is used here), that label will be prefixed or subscripted by the identifying number.



If a particular device has only one gating or control input then the identifying number may be eliminated and the relationship shown with a subscript.



If the input or output is affected by more than one gate or control input, then the identifying numbers of each gate or control input will appear in the prefix or subscript, separated by commas. In this example "X" is controlled by "G1" and "G2."



8-56. Control Blocks

8-57. A class of symbols for complex logic are called control blocks. Control blocks are used to show where common control signals are applied to a group of functionally separate units. Examples of types of control blocks follow.

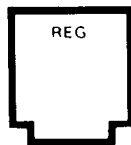

Register control block. This symbol is used with an associated array of flip-flop symbols to provide a point of placement for common function lines, such as a common clear.

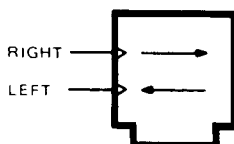

Shift register control block. These symbols are used with any array of flip-flop symbols to form a shift register. An active transition at the inputs causes left or right shifting as indicated.

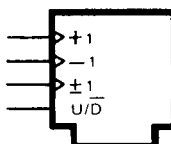

Counter control block. The symbol is used with an array of flip-flops or other circuits serving as a binary or decade counter. An active transition at the +1 or -1 input causes the counter to increment one count upward or downward, respectively. An active transition at the ± 1 input causes the counter to increment one count upward or downward depending on the input at an up/down control.

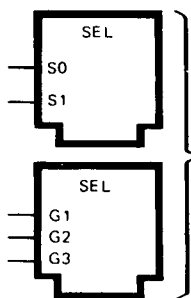

Selector control block. These symbols are used with an array of OR symbols to provide a point of placement for selection (S) or gating (G) lines. The selection lines enable the input designated 0, 1, ..., n of each OR function by means of a binary code where S0 is the least-significant digit. If the 1 level of these lines is low, polarity indicators (∇) will be used. The gating lines have an AND relation with the respective input of each OR function: G1 with the inputs numbered 1, G2 with the input numbered 2, and so forth. If the enabling levels of these lines is low, polarity indicators (∇) will be used.

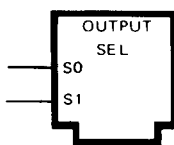

Output selector control block. This symbol is used with a block symbol having multiple outputs to form a decoder. The selection lines enable the output designated 0, 1, ..., n of each block by means of a binary code where S0 is the least-significant digit. If the 1 level of these lines is low, polarity indicators (∇) will be used.

8-58. THEORY OF OPERATION

8-59. Overall Counter Operation

8-60. The HP Model 5335A is a Universal Counter, whose basic function capabilities include frequency, period, time, ratio, totalize, and volts. The following description introduces the major functional circuit blocks, and refers to the Simplified Block Diagram in *Figure 8-2*.

8-61. The overall operation of the counter centers on the continuous interaction of the Multiple-Register-Counter (MRC) and the controlling μ P System. The MRC, referred to as a "counter-on-a-chip" is an LSI circuit, which contains the counting registers used to accumulate the raw input measurement data. The μ P System contains the processor, counter operating program (in ROM), and memory space (in RAM).

8-62. Inputs into Channel A (and/or Channel B) are routed through Signal Conditioning circuits which perform the operator selections of coupling, impedance, and attenuation. The signal is directed through a parallel input buffer stage, (which provides separate buffers for Hi and Lo frequency), through a protective Limiter, to the Input Schmitt Amplifier where it is buffered, shaped, level-shifted and input to the respective Channel Signal Multiplexor. The A and B Channel Signal Multiplexors accept the various input signals (Chan A, Chan A/2, Chan B, Chan C, DVM etc.), directing the required signal to the MRC inputs. The Trigger Mode Circuit configures the type of input channel triggering selected; either Manual or Automatic, Preset or Adjustable. Both input Channels have Peak-Detector circuits which during automatic modes, are used to derive DC levels representing the positive and negative peaks of the input. From these, the 50%, 10% and 90% points of the input signals can be utilized.

8-63. The outputs of the Channel A and Channel B Signal Multiplexors are directed to the MRC, where they are accumulated in registers, counted, and stored as raw measurement data. The data is then retrieved by the μ P System, manipulated to achieve the desired measurement mode, modified by special functions (if required) and routed to the Display. The local Reference Oscillator is directed to the MRC through the Oscillator Select circuit. An Interpolating configuration divides up the time between time base pulses, and allows the MRC to count with much finer resolution. For a typical measurement, the μ P reads the MRC's registers, reads the interpolator's counters, performs the necessary calculations and displays the result. In between measurements, the MRC's registers and the interpolator's counters are reset. The μ P system operates on a program, permanently stored in ROM, which allows it to continually cycle, making measurements, while routinely monitoring the MRC, the front panel Keyboard, and the HP-IB for inputs and interrupts. Additionally, the program in ROM provides for operator interactive Diagnostics, used during troubleshooting.

8-64. BLOCK DIAGRAM DESCRIPTION

8-65. Introduction

8-66. The following theory of operation begins with a description of the HP5335A Microprocessor System and Multiple-Register Counter, followed by a discussion of the Interpolator Technique, Triggering Modes and Peak-Detectors. Then the overall functional operation is described using the Detailed Block Diagram in *Figure 8-21*.

8-67. Microprocessor and M.R.C.

8-68. The 5335A is based on microprocessor architecture. It uses a Motorola MC6802 microprocessor, which has a built-in clock circuit and 128 bytes (8 bits by 128 words) of read/write memory (RAM). Supporting the microprocessor are two 65K bit ROM's (8 bits by 8192 words each) that form approximately 16K bytes of program storage area. There is an additional 256 bytes of program RAM provided by two 1K bit static memories used to provide buffering and address

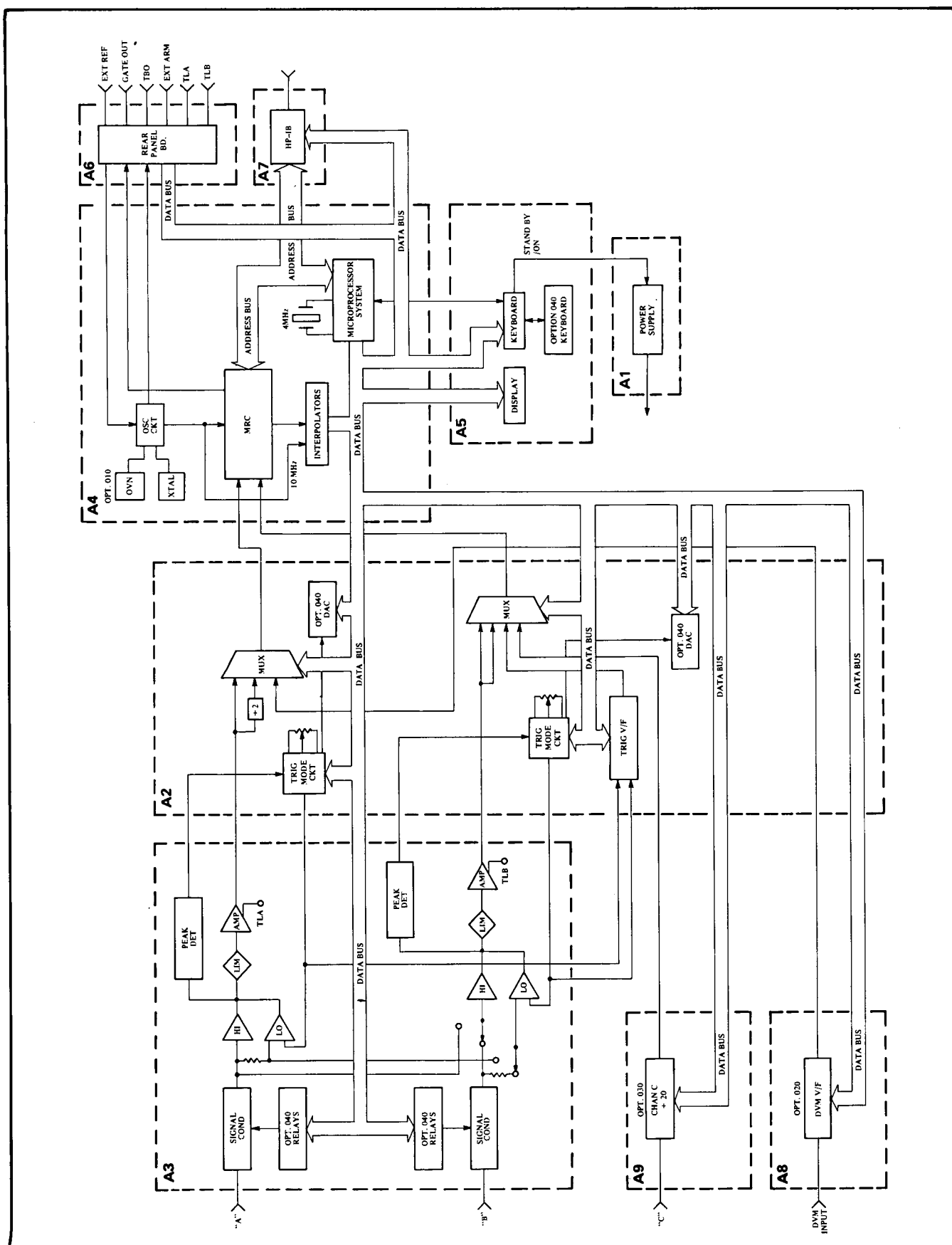

Figure 8-2. Simplified Block Diagram

decoding. The microprocessor, directed by the permanently stored program routines (in ROM), actively controls the overall operation of the counter. It monitors for interrupts and for operator instructions, either through the front panel keyboard or the HP-IB, and directs the appropriate circuit configurations. It retrieves data, performs all the necessary mathematical computations, and displays the results.

8-69. The general operation of the counter centers on the interaction between the microprocessor system and the MRC. The MRC (Multiple-Register-Counter) is an LSI bipolar IC, utilizing both EFL and I²L circuitry. It is a programmable universal counter-on-a-chip, containing four sets of registers; Events, Time, Status, and Control. The E (Events) and T (Time) registers collect the raw input measurement data. The S (Status) register includes E and T register overflow flags and information on the state of the measurement. The C (Control) register, directed by the μ P (microprocessor), sets up the various measurement modes of the MRC, and resets the counters, synchronizers, and overflow flags. The MRC has inputs for Channels A,B,C, a time base, and an external arm signal. Outputs include two gate status lines, two interpolator lines, and a register reset line. When a measurement is completed, the MRC signals the μ P by pulling the IRQ (Interrupt Request) line. Using the accumulated Events and Time data, the μ P can then calculate the selected function mode measurement. For example, dividing the contents of the Events register by the contents of the Time register produces the frequency of the measurement. Likewise, dividing T by E yields Period, and Time Interval uses the contents of T directly.

8-70. The measurement's gate time is dictated either by the μ P or by a one-shot under front panel control. The time constant for the specified measurement time has two ranges; NORM, nominally 20ms to 4 seconds, and FAST, $\sim 100\mu$ s to 20ms. Gate Times are continuously adjustable (as opposed to decade steps) through these ranges and the μ P automatically includes gate time in its calculations.

8-71. The MRC is fully synchronous with both the input and the timebase. A "triple" synchronization circuit is used, which means that, with the use of Interpolators, the exact gate time of a measurement is used for computations.

8-72. Interpolator Technique

8-73. A major feature of the 5335A is its Interpolators. By using Interpolators the inherent ± 1 count error is effectively reduced by a factor of 200. The basic principle is to detect the slight error factor, and then proportionally expand it (200X) to a time length which can be measured by the counter. Then, by using known calibration pulses, the actual error factor can be interpolated. The error is then effectively cancelled by compensating the MRC's adjustable gate time. The use of Interpolators allows measurements to be resolved to near one nanosecond.

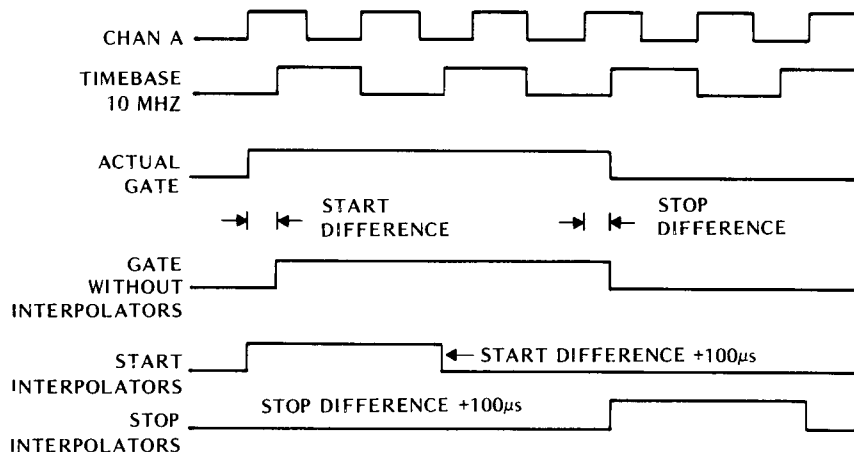

8-74. Without Interpolators, the Gate signal during a measurement would normally be synchronous with the main clock (timebase). The slight time difference between the actual events of Channel A triggering, and the opening and closing of the gate, would represent an unrecoverable error factor, limiting the accuracy of the measurement. The Start and Stop Interpolators within the 5335A provide a method of determining the amount of time error (for both start and stop events) and adjusting the μP 's "gate time" factor to compensate.

8-75. The MRC provides Start and Stop Interpolator pulses, representing the time difference (error factor) between Channel A trigger events and the Timebase. To measure these pulses, a dual slope integration scheme is used. Basically, the short Interpolation pulse, from the MRC, is used to rapidly charge a capacitor, via a constant current source. When the pulse ends, the capacitor begins a "scaled discharge" at about 1/200th the charge rate. This "proportionally" expands the interpolator error pulse by a factor of 200X. This integrated waveshape is then squared and used to gate a time base signal into the Interpolator's counter. The count in the counter will proportionally reflect the length of the Interpolator pulse.

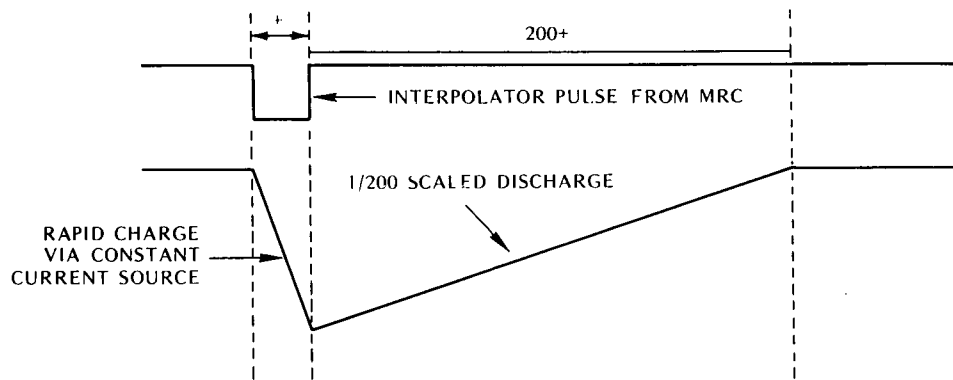

8-76. To convert the count in the Interpolator counter to real nanoseconds, the MRC provides two calibration pulses; a short calibration pulse of 100ns and a long calibration pulse of 200ns. By inputting each of these "known" pulse lengths into the same integrator and noting the number of counts produced, a mathematical proportion is established, with which the true time for any pulse length can be interpolated. For example, if the short (100ns) calibration pulse produced 200 counts, and the long (200ns) calibration pulse produced 400 counts, a pulse of 150ns would produce 300 counts. Inversely, if 300 was the number of counts accumulated during the Interpolator pulse integrator cycle, then the error factor would be 150ns.

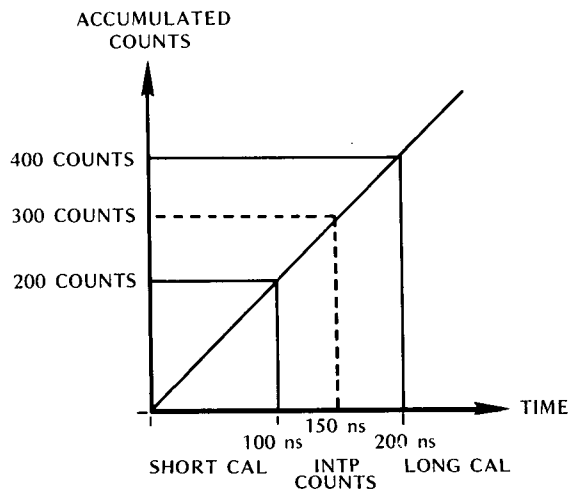

8-77. The final equation for determining the actual gate time is:

$$\begin{aligned} \text{GATE TIME} &= (\text{Counts in T-register}) \times 100\text{ns} \\ &+ \frac{\text{Count X} - \text{Count S}}{\text{Count L} - \text{Count X}} \times 100\text{ns (for the Start Interpolator)} \\ &- \frac{\text{Count X} - \text{Count S}}{\text{Count L} - \text{Count X}} \times 100\text{ns (for the Stop Interpolator)} \end{aligned}$$

where Count X = effective counts from Interpolation pulse

Count S = effective counts from short calibration pulse

Count L = effective counts from long calibration pulse

For example, given the following values:

Count in MRC's E register	= 356
Count in MRC's T register	= 10
Count from Start Interpolator	= 100
Count from Stop Interpolator	= 230
Count from short calibration pulse	= 200
Count from long calibration pulse	= 150 (+ 256)

$$\begin{aligned} \text{GATE TIME} &= (10 \times 100\text{ns}) + \frac{356 - 200}{406 - 200} \times 100\text{ns} - \frac{230 - 200}{406 - 200} \\ &\times 100\text{ns} = 1000 + 80.1 - 14.6 = \underline{1065.5\text{ns}} \end{aligned}$$

8-78. If this were a time interval measurement, the μP would be able to tell you the exact answer to about 1ns accuracy. In actual measurements the interpolators will yield different counts, other than the 200 and 400 counts indicated here.

8-79. The general measurement program routine is to make a measurement, read the MRC's registers, read the interpolator counters, perform the calculations, and display the results. In between measurements, the MRC's registers and the interpolator's counters are reset.

8-80. Auto-Triggering and Peak-Detectors

8-81. There are four major trigger modes used in the 5335A. The comparative relationship between these modes is illustrated below.

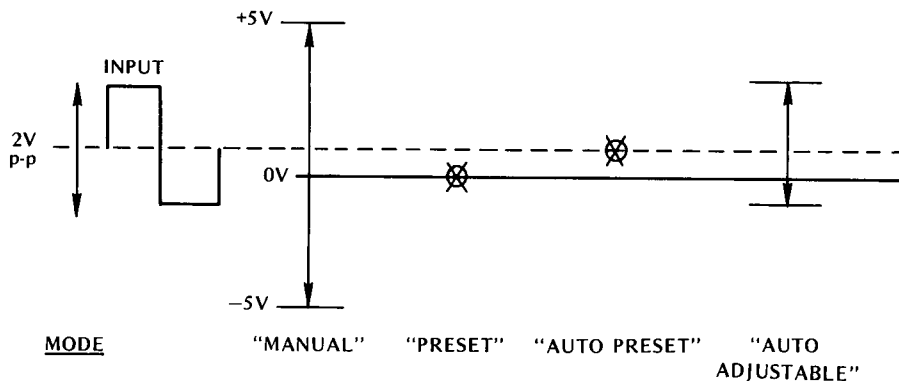

8-82. The MANUAL and PRESET modes derive the trigger level in a conventional fashion; by setting the trigger level adjustment to some point between the hardwired -5V and $+5\text{V}$ dc levels. The AUTO triggering modes, however, derive their trigger levels, based on the amplitude and dc component of the input signal. The AUTO PRESET mode sets the trigger level at the 50% point of the input signal, and the AUTO ADJUSTABLE mode allows selection of any level between the positive and negative peak levels of the input signal.

8-83. An essential part of the AUTO Triggering modes is the operation of the Peak-Detectors, which are used to produce DC levels, representative of the positive and negative peaks of the input signal. Using these levels, the 50%, 10%, and 90% points of the input signal can be determined. These points, totally relative to the input, are made available as trigger levels for AUTO modes. Most measurements use the 50% point. Rise and Fall measurements use the 10% and 90% points.

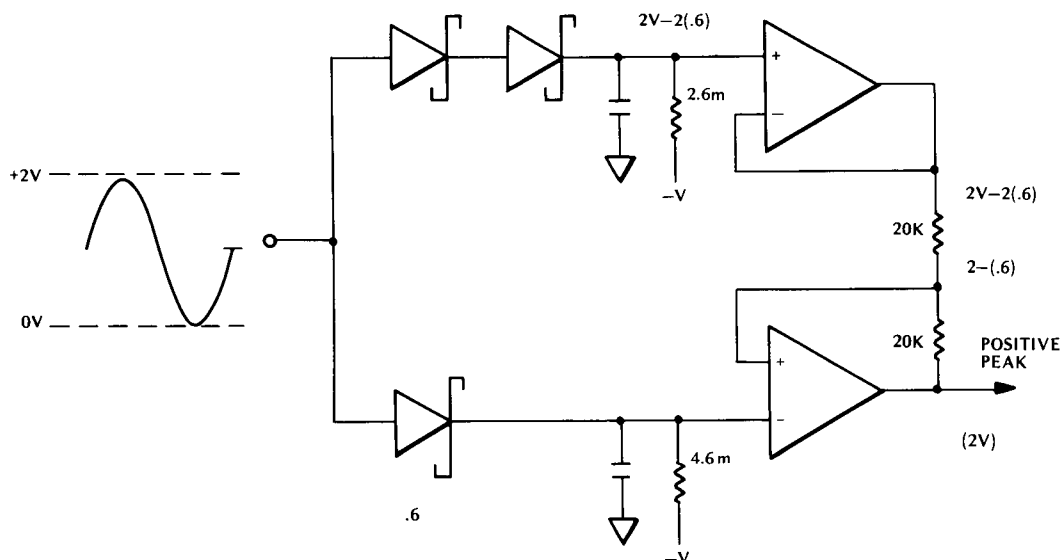

8-84. A basic peak-detector consists of a diode and a capacitor. This circuit, however, presents several inherent problems; primarily the $.6\text{V}$ drop across the diode and the non-linear response related to the duty cycle of the input. The peak-detector circuit used in the 5335A compensates for these factors by providing two parallel peak-detectors in a balanced configuration. One peak-detector is used to compensate the other for any errors. For example, if the positive peak of the input sinewave is at $+2\text{V}$, the lower detector will charge the capacitor to about $2\text{V}-V_d$. The upper detector will charge the capacitor to about $2\text{V}-2V_d$ and pass through a unity gain buffer, to offset the lower detectors buffered output. The output will be $+2\text{V}$, and all factors due to the diodes cancel out. There are four of these peak-detectors in the counter's front end, one for each peak of both channels. The diodes are reversed in the negative detectors.

8-85. To turn off the peak-detectors, the diodes need to be back biased. The operator turns off the detectors by turning off the AUTO mode on the front panel. This switch is read by the microprocessor, which controls the auto circuitry that back biases the detectors.

8-86. The outputs of the two channel peak-detectors are connected to either end of the trigger level adjustment pot. When AUTO is off, the ends of the pot are at $+5.2$ and -5.2 which is the Manual range of adjustment. When the AUTO mode is turned on, the ends of the trigger level adjustment pot are the positive and negative peak levels of the input signal, provided by the respective peak-detector. The entire range of trigger level adjustability is repositioned within the peak-to-peak amplitude of the input signal, which for most situations vastly increases the resolution of the setting.

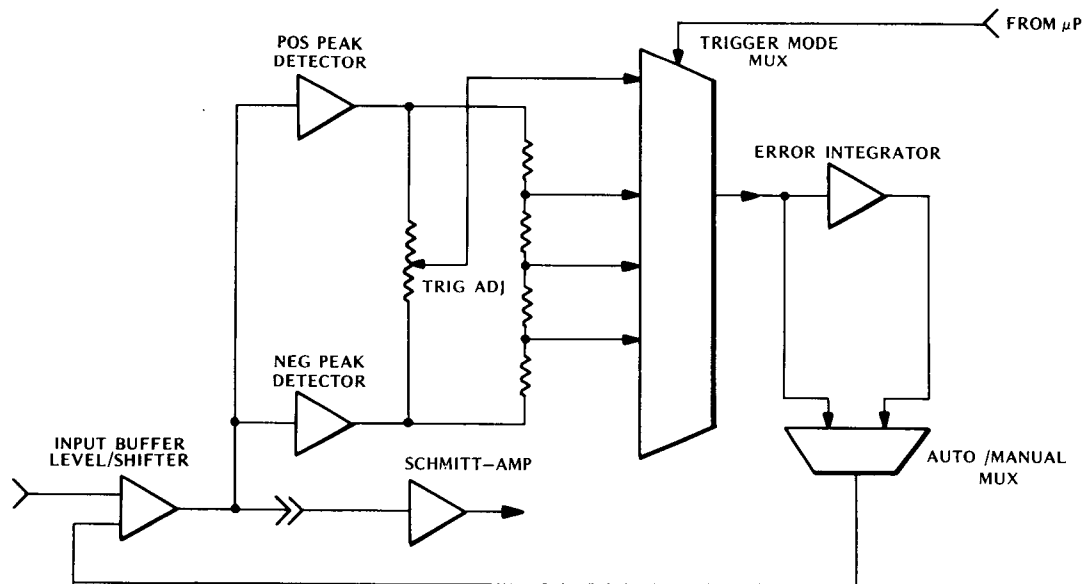

8-87. The Trigger Mode Multiplexors, controlled by the microprocessor, configure the selected trigger level mode. In the MANUAL ADJUSTABLE mode, the trigger level goes through the Trigger Mode mux, then through the Auto/Man mux to the input level shifting buffer. The +5 and -5 volt levels used in the MANUAL mode are derived from circuitry that sets the peak detectors to +5V and -5V. In the AUTO ADJUSTABLE mode, the trigger level (derived from the input peak detectors) go through the Trigger Mode mux and then through an Error Integrator, which tries to adjust the trigger level to about zero. The difference error is then routed through an analog switch to the input level shifting buffer, which correspondingly shifts the "input signal dc level" to the error value. It is important to realize that in the HP5335A, the input Schmitt-Trigger/Amplifier trigger level is ALWAYS set to zero, and that it is the level of the input signal that is varied by the trigger level adjustment. In other words, instead of bringing the trigger point up to the desired trigger setting, the INPUT SIGNAL LEVEL is brought down to the trigger point, which is always zero.

8-88. The other two trigger modes, PRESET and AUTO PRESET, are special cases of Manual and Auto Adjustable. For PRESET, the Trigger Mode Mux selects the analog ground input. The Error Integrators are not used. For AUTO PRESET (the 50% point) the mid point of the resistor divider is selected. Since the resistor divider network is tied to the peak detectors, the Error Integrators are used. The resistor divider also provides the 10% and 90% points, selectable by the Trigger Mode Mux for Rise and Fall modes.

8-89. Reading Trigger Levels

8-90. The 5335A has the ability to measure its trigger levels, using a dedicated dc voltmeter. A single V-F DVM is used to measure all of the combinations of trigger levels, for both channels.

8-91. Using this arrangement, the microprocessor selects any one of the DC inputs to feed the V-F converter. The output frequency is measured by the MRC and the μP calculates the proportional voltage. The calculations use three known calibration points, 416 -5V, 0V, and +5V, derived from a precision voltage reference on the power supply assembly. Pressing the TRIG LVL key on the front panel directs the μP to measure and display the current Channel A and Channel B trigger levels. The voltmeter alternately measures Channel A and Channel B; the display of both levels, however, appears constant.

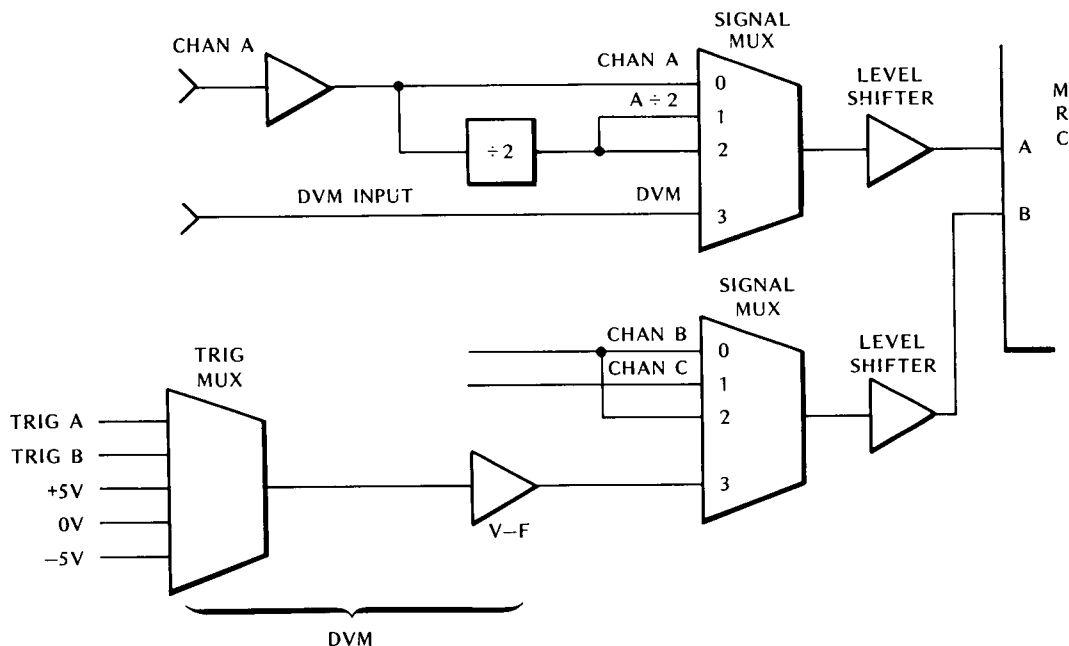

8-92. Detailed Block Diagram Description

8-93. Inputs to the counter are received through Channels A, Channel B, Channel C, and the DVM.

8-94. The front end amplifiers (Channel A and B) are a pair of high performance 200 MHz matched circuits. They have a sensitivity of 25mV RMS, and can trigger at any point between ± 5 Volts. The input signal passes through the AC/DC select circuit, past the 50/1Meg ohm select switch, through the X1/X10 attenuator switch, to the input impedance converter buffer. The selection of Separate/Common is accomplished by a relay, controlled by the microprocessor. This allows the selection of Sep/Com either by front panel control or via the HP-IB.

8-95. The input buffer circuit is a parallel amplifier configuration. The signal is split and buffered in two parts. One part is AC coupled to a FET voltage follower, which buffers all the high frequencies (above 10kHz). The other part is DC coupled to an Operational Amplifier, which buffers the lower frequencies. The Trigger Level from the Trigger Mode multiplexor is also input at this point to offset the signal. This signal is inverted, then reunited with the high frequency path. The combined signal is then passed through an emitter follower transistor, through a protective bridge limiter to the Schmitt-Amplifier. The Schmitt-Amp is a high performance, 300 MHz Bandwidth device with settable hysteresis and a built-in three state trigger light circuit. The square wave output of the Schmitt-Amp is then level-shifted to ECL, and input to the channel Signal Multiplexor. The Channel A signal is also tapped off, and a divided-by-two version is input to the Multiplexor.

8-96. Triggering for each Channel is determined by the Trigger Mode Selector, from the four major modes of triggering available; Manual, Preset, Auto-Preset, and Auto-Adjustable. Other unique modes set trigger points to 10% and 90%, for rise and fall time measurements. Many of these triggering modes involve the channel Peak-Detectors, which detect the voltage extremes of the incoming signal. The microprocessor, responding to operator instruction and Function mode, selects the proper trigger level, and directs it through the Trigger Mode Mux to the Input Buffer. The trigger levels for both channels are also directed through a dedicated Trigger Level DVM, and input to the Channel B Signal Mux.

8-97. The Channel C input passes through a fused input BNC connector, through a protective limiter to the PIN Diode Attenuator. This attenuator provides a nominal amount of control of input sensitivity, via a front panel control. The output of the attenuator feeds the Broadband Amplifier. The output of the Amplifier is prescaled by 20, via a decade divider and a binary divider. This prescaled signal is then routed to the Channel B Signal Mux. A Peak Detector and Schmitt Trigger circuit are used to effectively disable the Channel C output (via the Binary Divider) whenever the Peak Detector level is below the threshold level. The μ P enables the Channel C through a Flip-flop which clocks the Binary Divider, allowing the prescaled signal to pass.

8-98. The Digital Voltmeter input passes through a programmable attenuator, controlled by the μ P, through a multiplexor to a V-to-F Converter. The dc level is compared to a voltage reference, and converted to a frequency. The output of the V-to-F is then buffered and routed to the Channel A Signal Mux, and eventually to the MRC, where it can be counted, interpreted and displayed as a voltage.

8-99. The desired output(s) of the Channel A and B Signal Multiplexors are selected by the microprocessor, Level-shifted (to MRC specific logic levels) and input to the MRC as Chan A and Chan B, respectively.

8-100. The MRC's control register is directed by the μ P to set up for the type of measurement, and reset the counters, synchronizers and overflow flags. The Events and Time registers collect the measurement data. The Status register monitors the E and T register overflow flags and the state of the measurement. Whenever there is an overflow in either counting register, or the measurement is completed, the MRC signals the μ P via the IRQ (Interrupt Request) line. The μ P by polling the MRC's Status register, identifies the source and type of request. The μ P can then read out the E and T registers, reset IRQ, and perform the indicated calculations. This information is then latched into the display assembly. When the μ P reads or writes data to the MRC the Memory Ready line is used to slow the μ P down to a speed compatible with the MRC. The MRC holds this line low to temporarily delay the μ P.

8-101. The measurement time for the MRC is set either by a one-shot under front panel control, or by the μ P. The selected gate time is slightly modified by the μ P to compensate for any error factor determined by the interpolators. The gate time is continuously adjustable over two ranges, NORM and FAST. NORM is nominally 20ms to 5s, and FAST is 100 μ s to 20ms. A buffered TTL level output is provided to the rear panel representing the gate signal. The Gate open and Gate closed signals from the MRC are X-ORed to produce a GATE OUT signal. This signal is high when the gate is closed and low when the gate is open.

8-102. The standard time base for the MRC is a 10 MHz crystal oscillator. Additionally, provisions are made to allow for an optional high stability ovenized oscillator (i.e. HP 10811). The microprocessor has its own associated oscillator, which generates an approximate 4MHz clock. This signal is divided down to 1MHz within the μ P, and output to the counter as the main Enable clock. All timing parameters within the counter are referenced to this clock.

8-103. Either 5 or 10 MHz may be used as an external reference. An Ext Ref Buffer/Multiplier circuit accepts any submultiple of 10MHz, and outputs a 10MHz frequency. The buffer automatically determines whether or not the Ext Ref input has enough amplitude to work.

8-104. The switching between the internal and external timebase signals is automatic. Whenever an external reference is connected to the rear panel, an Ext Ref Peak Detector circuit senses the signal and configures the Timebase Multiplexor to pass the Ext instead of the local oscillator. The output of the Ext Ref Peak Detector also goes to the μ P, which prompts the μ P to turn on the front panel External Timebase annunciator and send the status to any devices on the HP-IB. The selected timebase is also buffered and provided to the rear panel for an auxiliary Timebase Out.

8-105. The rear panel EXT ARM input, in conjunction with two three position slide switches, allows the external arming of the start and/or stop of a measurement. The TTL EXT ARM input is buffered and converted to MRC compatible logic levels, and directed to the MRC. The MRC internally compensates for external arming. Although externally armed, the measurement does not start or stop until an input signal is received.

8-106. The DISPLAY assembly receives already decoded segment data from the μ P, latches it and inputs it to three LSI display IC's. These IC's then output the data, scanning the display with self-contained strobe circuitry. All information from the keyboard is transferred to the μ P through an interrupt scheme. The front panel keys are arranged into a matrix. In the quiescent state, no regular scanning of the matrix is performed. However, when a key is pressed, an interrupt line to the μ P is activated. The μ P scans its I/O bus and identifies the keyboard. It then performs a subroutine that scans the keyboard matrix, and responds to whatever key was pressed. If no key, or more than one key is found pressed, the program ignores the interrupt.

8-107. The HP-IB Interface Logic Assembly serves as an interface between the 5335A and an external controller, via the HP-IB Interface Bus. The circuitry includes bus buffers, decoding ROMS and an LSI HP-IB interface IC. These circuits perform the handshake and interpret commands, data, interrupts etc.

8-108. The Power Supply, using simple linear regulators, provides the following dc voltages: +15V, -15V, +5V, -5.2V, and +3V. In addition, an un-regulated +24V for the optional oven oscillator, and a precision +10.00V reference for the trigger level DVM is provided. All supplies, except the +24V oven, are activated through a power relay, controlled by a low voltage front panel power switch. An LED near the switch indicates the STANDBY power position, meaning all supplies are disabled, except for the oven supply unless the instrument is completely disconnected from the main power line.

8-109. BUILT-IN DIAGNOSTICS

8-110. Introduction

8-111. The 5335A Universal Counter is a microprocessor-based system with thirty-three built-in diagnostic subroutines. These diagnostics can be used for automatic testing, and as an aid in troubleshooting the 5335A. Most of the diagnostic subroutines are used in a SUPER-CHECK routine. They can also be accessed directly for testing and troubleshooting of a specific section of the counter. A combination of diagnostic subroutines can be used to isolate a faulty section or group of components within the 5335A. Once the 5335A has been set in the diagnostic mode, switching from one diagnostic to another may be as simple as keying in the desired diagnostic number, with the exception of three diagnostics. (i.e., to exit Diagnostic #2, Diagnostic #6, and Diagnostic #17, you must cycle the 5335A power switch to STBY and back ON again.)

8-112. Accessing the Built-In Diagnostics

8-113. To access the built-in diagnostics from the front panel, there are certain conditions that must be met:

First, it is necessary to verify the proper operation of the **KERNEL**. The **KERNEL** is the heart of the system, the minimum hardware that must be functioning properly to operate the system. The **KERNEL** of the 5335A Universal Counter is the microprocessor (A4U28), the ROMS (A4U22 and A4U23), the RAMS (A4U25 and A4U26), the bi-directional buffers (A4U16 and A4U24), and the buffer (A4U27). (To verify the proper operation of the **KERNEL**, start with the POWER-UP SELF-CHECK, refer to *Table 8-3* step A.)

Second, the Address and the Data bus lines must not be shorted.

Third, the front panel display and keyboard must function properly.

Fourth, the power supplies and the microprocessor oscillators must be within specifications.

8-114. After successful completion of the POWER-UP SELF-CHECK, the 5335A must be set in the diagnostic mode. This is done by calling up Special Function 99. To call up Special Function 99 press the 5335A keys: SCALE, SMOOTH, 99, ENTER. To address a specific diagnostic, press: SCALE, the diagnostic number, and ENTER. Make sure the SCALE key lamp flashes after it is pressed. The non-cyclic diagnostic subroutines can be re-enabled by simply pressing RESET.

8-115. Any failures during the power-up cycle will disable the counter and produce one of the following:

1. A blank display.
2. A hieroglyphic is displayed.
3. Display shows a missing segment or digit.
4. Numbered ERROR or FAIL message is displayed.

NOTE

The fail messages are displayed in a continuous loop, and generally indicate a hardware related problem. Error messages indicate that the user has attempted an improper operation, either through the keyboard or the HP-IB. *Table 4-2* lists the Error Messages, and *Table 4-3* lists the Fail Messages.

8-116. DIAGNOSTIC #1 “SUPER CHECK”

8-117. This diagnostic exercises a large portion of the 5335A Universal Counter. First, the microprocessor must be functioning properly. If it is not, the display may be blanked, a hieroglyphic may be displayed, or the 5335A will not respond to the front panel keys. If this is the case, the microprocessor can be tested using the Signature Analysis troubleshooting technique, with the microprocessor set in the FREE RUN MODE. Refer to *Table 8-6, Signature Analysis of the Microprocessor*, for the FREE RUN procedure. (See *Figure 8-3, Troubleshooting Flowchart*, for further information concerning display types and possible failure messages.)

NOTE

For Signature Analysis troubleshooting, ensure that the 5335A is NOT connected to the HP-IB bus.

8-118. Second, the ROMS (A4U22 and A4U23) are tested by the microprocessor, using a CHECKSUM. Each 8K ROM is divided into four 2K blocks. The 16-bit CHECKSUM is stored in the first two bytes of each 2K block. The CHECKSUM represents the correct arithmetic sum of the rest of the bits in each 2K block. The microprocessor adds all the words stored in the remaining bits of each 2K block and compares this with the CHECKSUM. If the resulting sum does not match the CHECKSUM, FAILURES 1.0 – 1.9 will be displayed, or the 5335A display will be blanked. Refer to *Table 8-7* for the Signature Analysis of the ROMS.

8-119. If no failure is indicated at this point, there is a high probability that A4U28 (microprocessor), A4U22 and A4U23 (ROMS), A4U24 and A4U27 (buffers), and A4U21 and A4U10 are functioning properly.

8-120. The next test performed is on the RAMS. They are tested for their ability to be written to and read from. The 5335A contains two RAMS, the microprocessor on-board RAM (internal to the 6802 microprocessor) and the U25/U26 RAM. When the same bit pattern that was written is not read back, FAILURES 2.0 – 2.2 will be displayed, the display will be blank, or a hieroglyphic could be displayed. If any of these failures are displayed by the 5335A, refer to *Table 8-8* for the Signature Analysis of the Output Ports. The procedure given in *Table 8-8*, uses the RAMS to write the stimulus pattern for “key signature” troubleshooting in the A4 Main Logic Assembly, A5 Keyboard and Display Assembly, A7 HP-IB Logic Assembly and in the A8 DVM Assembly.

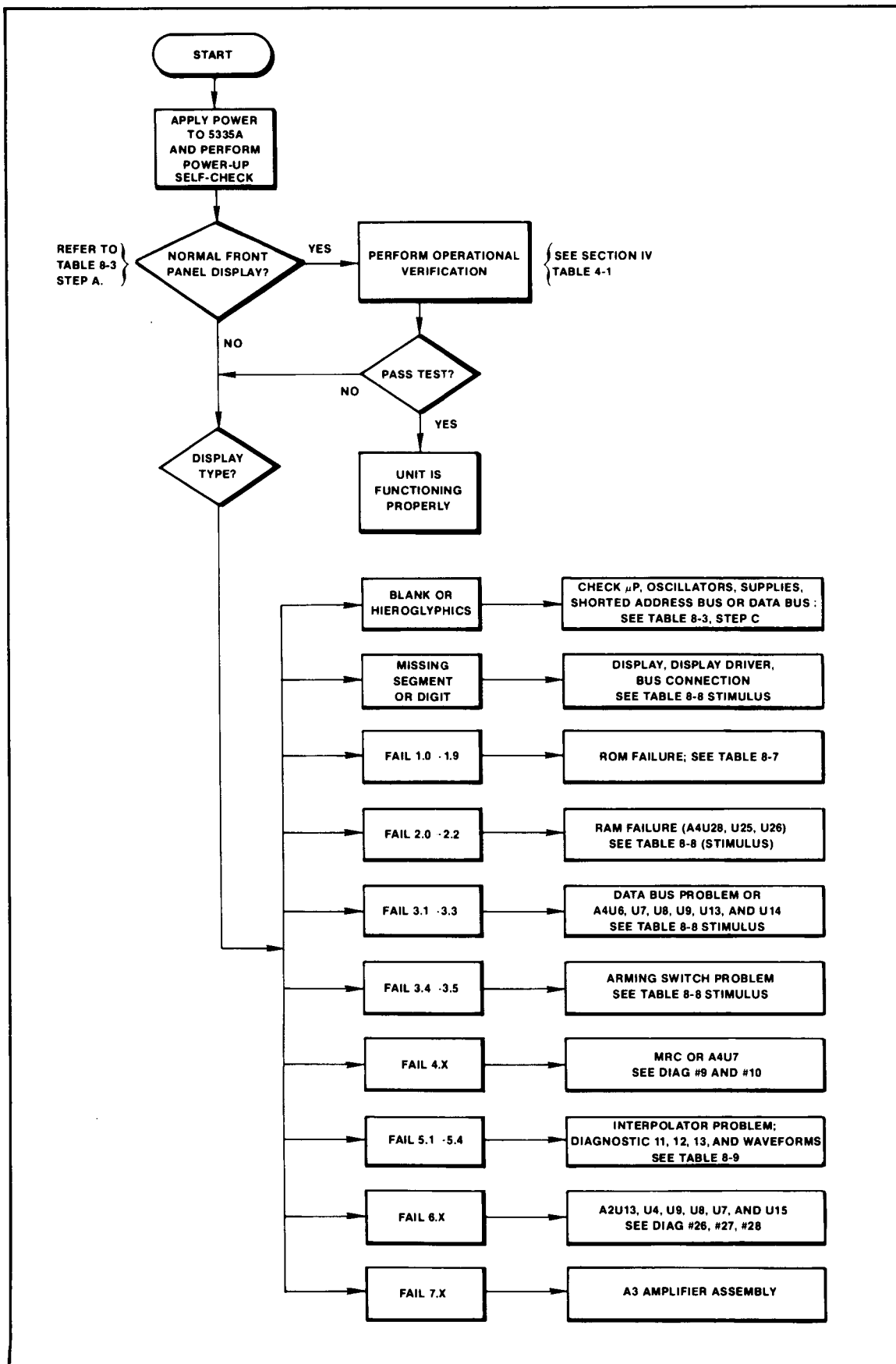

Figure 8-3. Troubleshooting Flowchart

8-121. The microprocessor then proceeds to test the front panel display board which includes the annunciators, the momentary switches, the switch LED's, and the front panel display LED's. All display and annunciator lamps turn on for about one second. Visual failures such as a defective seven-segment-display, key lamp, or display annunciator will be detected during this portion of the test.

8-122. Next, the Data Bus is checked in two ways. First a ground signal is forced through Data line six (D6). The microprocessor sets up the conditions for A4U20(12) to enable A4U16 and A4U10. In turn A4U10 enables A4U19. Then A4U19(15) enables A4U15, which sets up the ground signal, and forces the signal onto D6. Data line six sends the signal through A4U16 and A4U24 and back to the microprocessor. The second place of the check is done by reading the Data Bus at the output of the Interpolator Counters which were reset by the MRC [A4U6(29)]. Errors 3.1 through 3.3 will be displayed if the microprocessor does not receive the given expected conditions. The procedure in *Table 8-8, Signature Analysis of the Output Ports*, should isolate any problem developed while performing this test.

8-123. The proper internal operation of the MRC is verified next. The Status, Events and Time registers are thoroughly tested, (i.e., reset condition, end-of-measurement status, and their overflow conditions). Bidirectional buffer A4U7 is also tested in conjunction with the MRC. Any 4.X failure displayed indicates a faulty MRC or a defective A4U7.

8-124. The next block of circuitry tested is the START and STOP interpolators. The MRC generates a set of calibrating pulses and a Reset pulse. The calibrating pulses are used for testing the Charge and Discharge current sources and A4U4 and A4U5. The Reset pulse resets the interpolator counters at the end of each measurement test. A4U6, A4U4, A4U5, A4U8, A4U9, A4U13, A4U14, and the interpolator circuits are tested in this section. If a failure occurs at this point in the test, checkout the START and STOP interpolators by referring to *Table 8-9, Troubleshooting the Interpolators*.

8-125. The internal Trigger Level Voltmeter in the Amplifier Support Assembly (A2) is tested next. The +5V, 0V and -5V references are read through A2U4 (selected by A2U15), and converted to a frequency in A4U9, then level shifted by A2U8. The signal is then selected by A4U7 the multiplexor, and again level-shifted by A2U6 into the MRC. Failures 6.1 through 6.3 will be displayed if these circuits do not function properly.

8-126. The next major test is performed on the 5335A Front End. The Time Base Out (TBO) must be connected to INPUT A. The presence of the signal in Channel A is sensed (if no signal is present at INPUT A, ERROR 7.0 is displayed), then the accuracy of the applied signal is checked, the COM A/SEP relay is checked in SEP and then in COM A (the presence and accuracy of the signal in Channel B is verified), then the Channel A prescaler is tested (A2U11 and A2U7). Failures 7.1 through 7.5 will be displayed if any malfunction is detected at this time. A "FE PASS" message will be displayed if all the above tests are successfully completed.

8-127. Three supplies are checked next in the A2 Amplifier Support Assembly. The +5V by A2U4(2,6), the +3V by A2U4(12) and the -5.2V by A2U2(3). These voltages are converted into their equivalent frequencies by A2U9 then routed through A2U8, A2U7, and A2U6 the MRC. Refer to *Table 8-4, Power Supply Test* for the power supplies nominal voltages and their tolerances.

8-128. The whole procedure is then repeated, looping back to check the ROMS again.

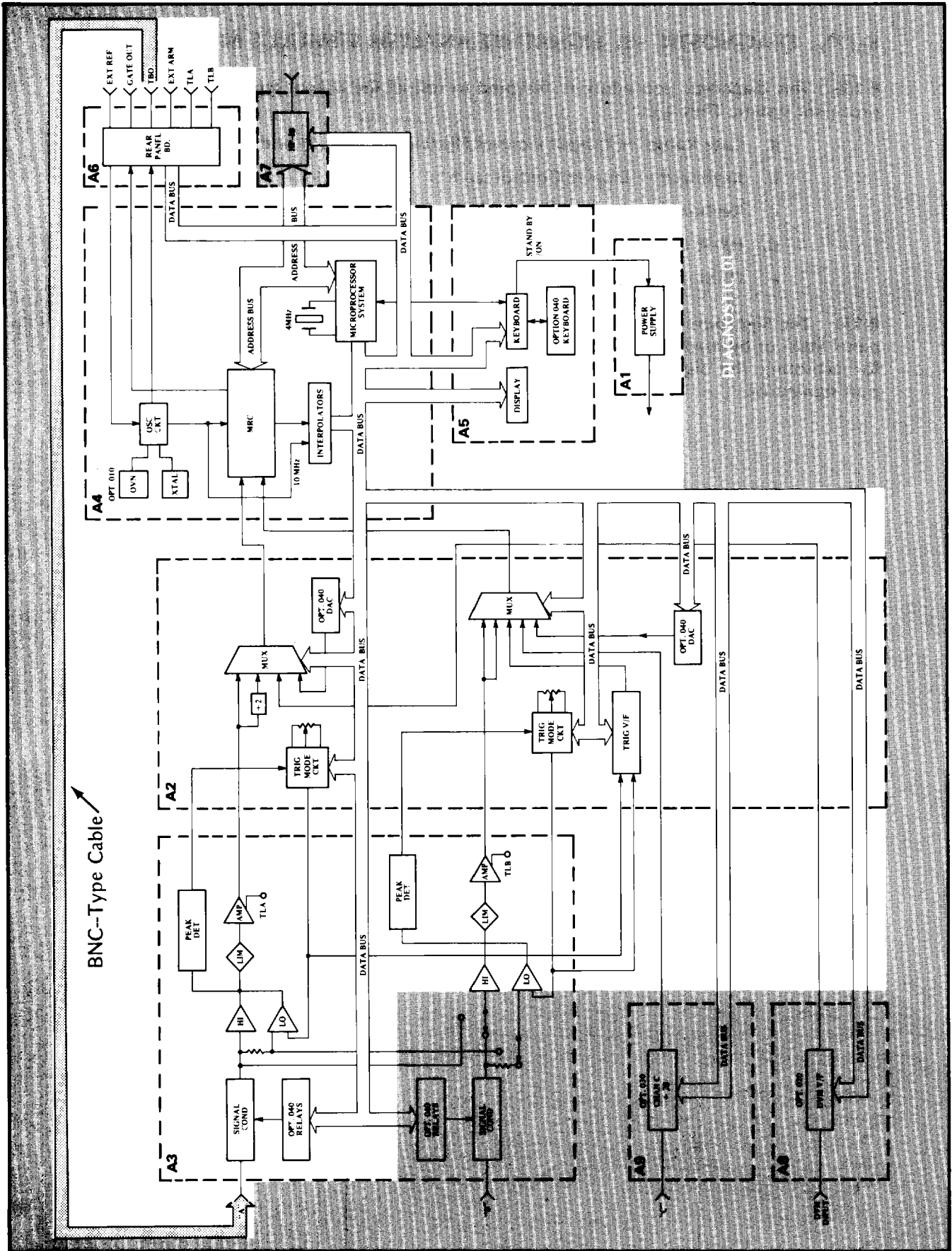

Figure 8-4. Diagnostic 01

8-129. DIAGNOSTIC #2: SIGNATURE ANALYSIS STIMULUS MODE

8-130. This diagnostic procedure is designed to test all the output type ports of the micro-processor system. They are:

- a. Gate Range — Output Control Flip/Flops (A4U11 and U18)
- b. Keyboard — Display Control latch (A5U4)
- c. Keyboard — Display Data latch (A5U5)
- d. HP-IB Data Output port (A7U1, U4, U7 and A14J3)
- e. DVM option Control latch (A8U3)

8-131. The Signature Analysis Stimulus Mode can be evoked through software (via the front panel keys) or by hard-wire (using a jumper wire on A14). *Table 8-8* describes the procedures for activating the Signature Analysis Stimulus Mode, and provides the expected output port signatures.

8-132. DIAGNOSTIC #3 AND #4: FRONT END LATCH CONTROL TEST

8-133. These diagnostic subroutines are designed to aid in the troubleshooting of the Front End Latch Control IC's A2U15 and U12 and related circuitry, including A3K1 in the standard front end.

8-134. They are also used to troubleshoot the latches of the programmable front end input (option 040), A11U16, U17, U8 and U24 and the related circuitry, including A12K1 through K9.

8-135. Diagnostic #3 sets the outputs of the latches to a TTL "LOW" and Diagnostic #4 sets them to a TTL "HIGH". Use a logic probe, oscilloscope, or voltmeter to verify the logic levels of the latch outputs, and that the levels change when going from Diagnostic #3 to #4.

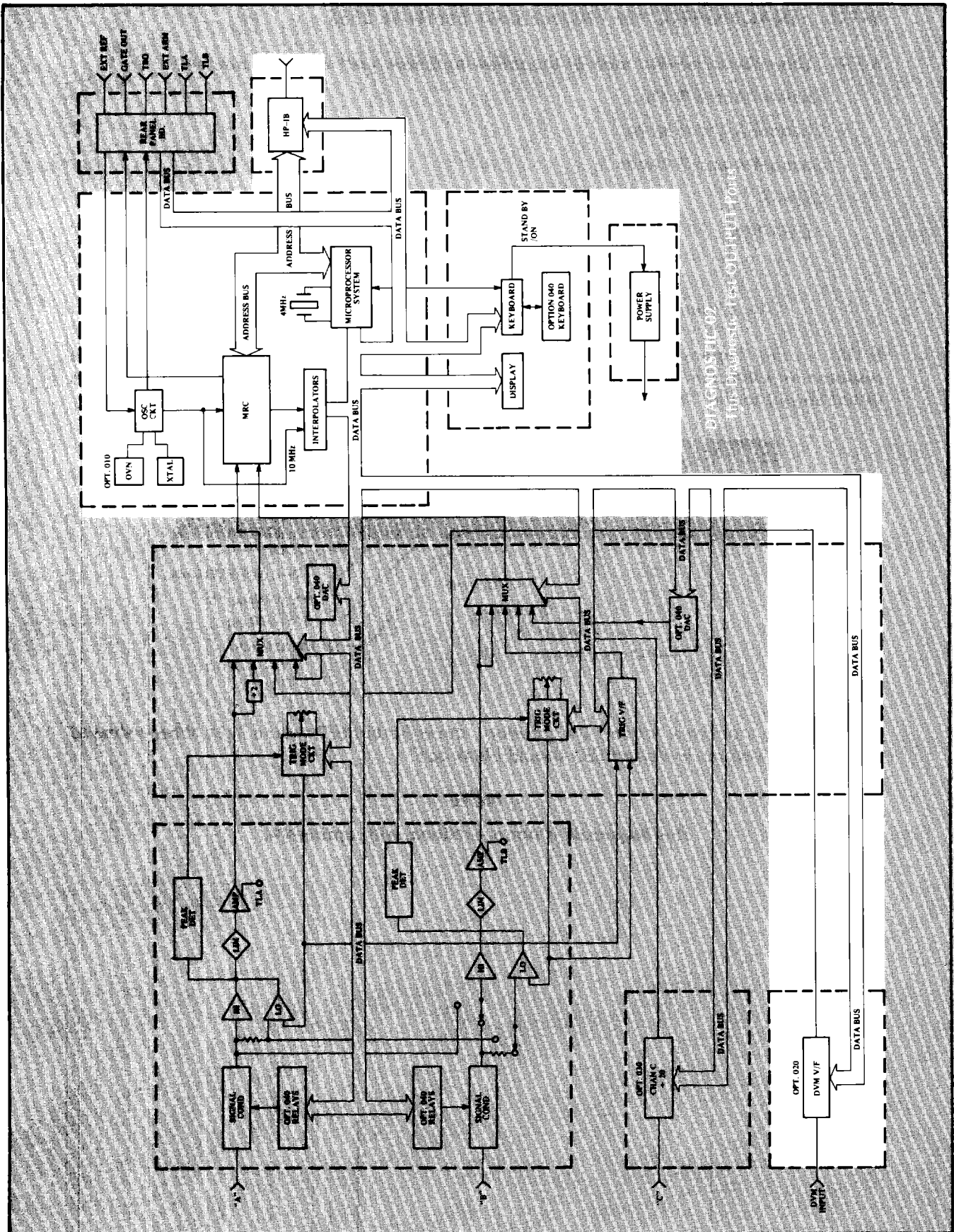

Figure 8-5. Diagnostic 02

8-136. DIAGNOSTIC #5: FRONT END SWITCH TEST

8-137. This subroutine tests each of the following 5335A front end data switches:

- Channel A and B X10
- Channel A and B Slope
- Channel A and B Preset
- COM A
- AUTO TRIG

NOTE

The Channel A and B 1M Ω /50 Ω and AC/DC switches are not tested.

8-138. In this diagnostic, the leftmost eight digits of the display are used to give an active response for each of the tested front end data switches. Begin by pressing all of the tested switches (listed above) to the "IN" position. Key-up Diagnostic #5 and observe the following display:

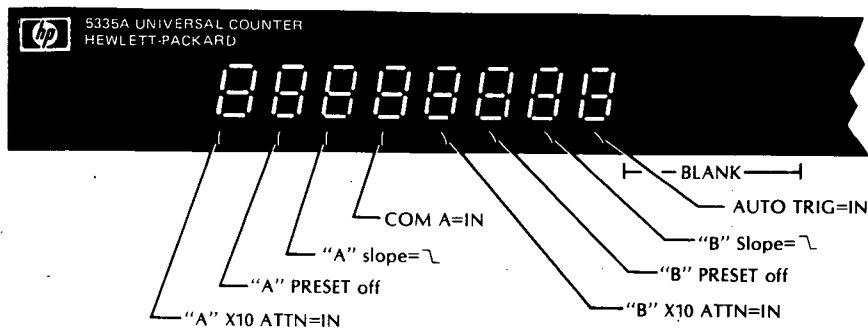

8-139. When a switch is active ("IN" position), the indicated LED should light. When released ("OUT" position) the indicated LED should blank out.

NOTE

This diagnostic is not operational with option 040.

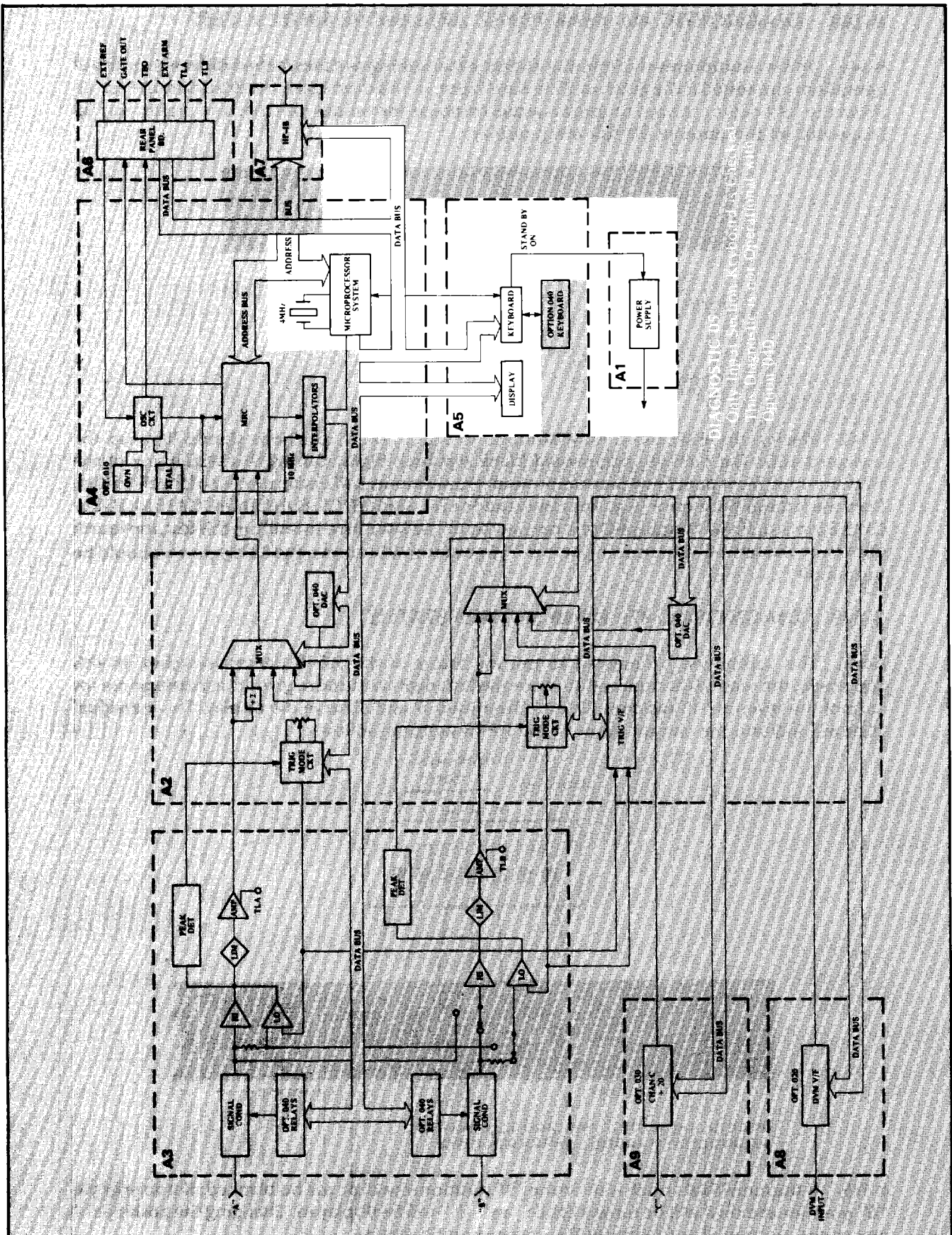

DIAGNOSTIC 05
Only Items in Item Knowledge Base
Have Diagnostic Symbols
Assigned

Figure 8-6. Diagnostic 05

8-140. DIAGNOSTIC #6: REAR PANEL ARM-SLOPE SWITCH TEST

8-141. This is a subroutine that tests the A6 rear panel arming switches in their different modes of operation; also tested is the External Time Base Input. In this diagnostic, the third through eighth (from the left) digits are used to give an active response for various switches and inputs. Key up Diagnostic #6 and observe the following display:

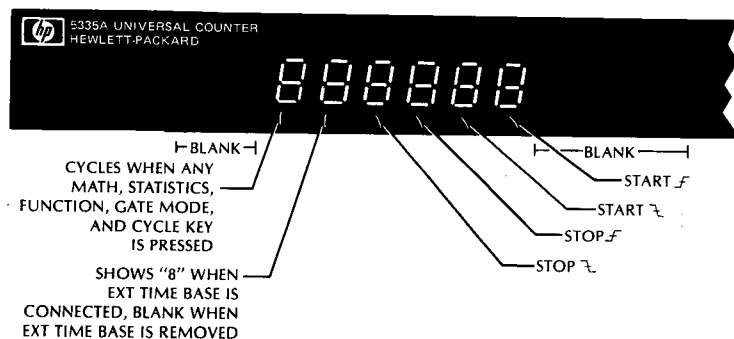

8-142. Placing the EXTERNAL ARM switches to the \mathcal{F} or \mathcal{T} positions should light up the indicated LED. The OFF position should blank out both digits. During this test, if any of the software-read front panel switches are pressed, the segments and decimal point of the third digit from the left will cycle once (e.g., keys from the MATH, STATISTICS, FUNCTION, GATE MODE or CYCLE blocks). If the Time Base Out is connected to the Time Base In while in this test, the fourth digit from the left will display an eight "8". To exit this subroutine, the 5335A power should be turned off.

8-143. DIAGNOSTIC #7: HP-IB SWITCH STATUS

8-144. This subroutine is designed to test the Status of the HP-IB address switches. In this diagnostic, the second through eighth (from the left) digits are used to give an active response for each of the seven HP-IB switches. Key up Diagnostic #7 and observe the display. The individual LEDs will indicate the current status of the HP-IB switch as follows:

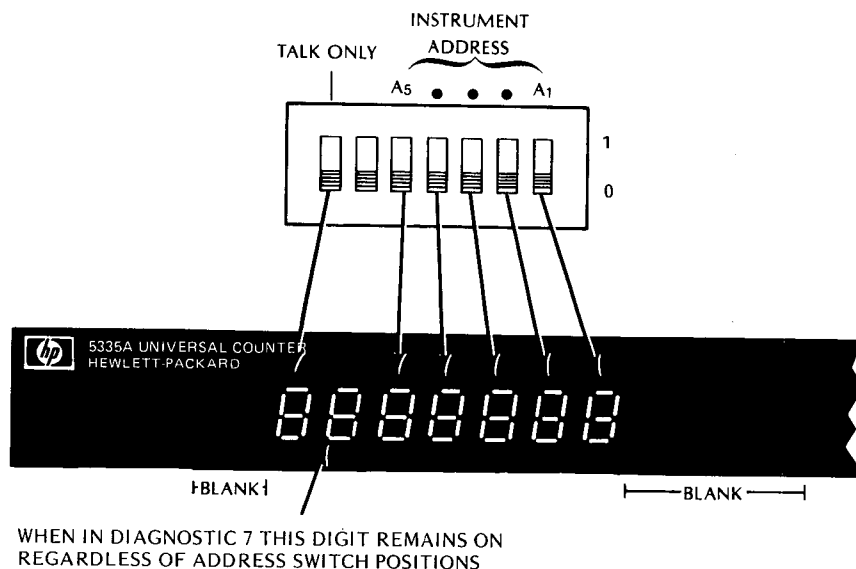

8-145. If the individual switch is set in the "1" position, the digit will be blanked; if it is set in the "0" position, the digit will be turned on, i.e., an "8" will be displayed. Changing the positions of any of the switches should change the corresponding display.

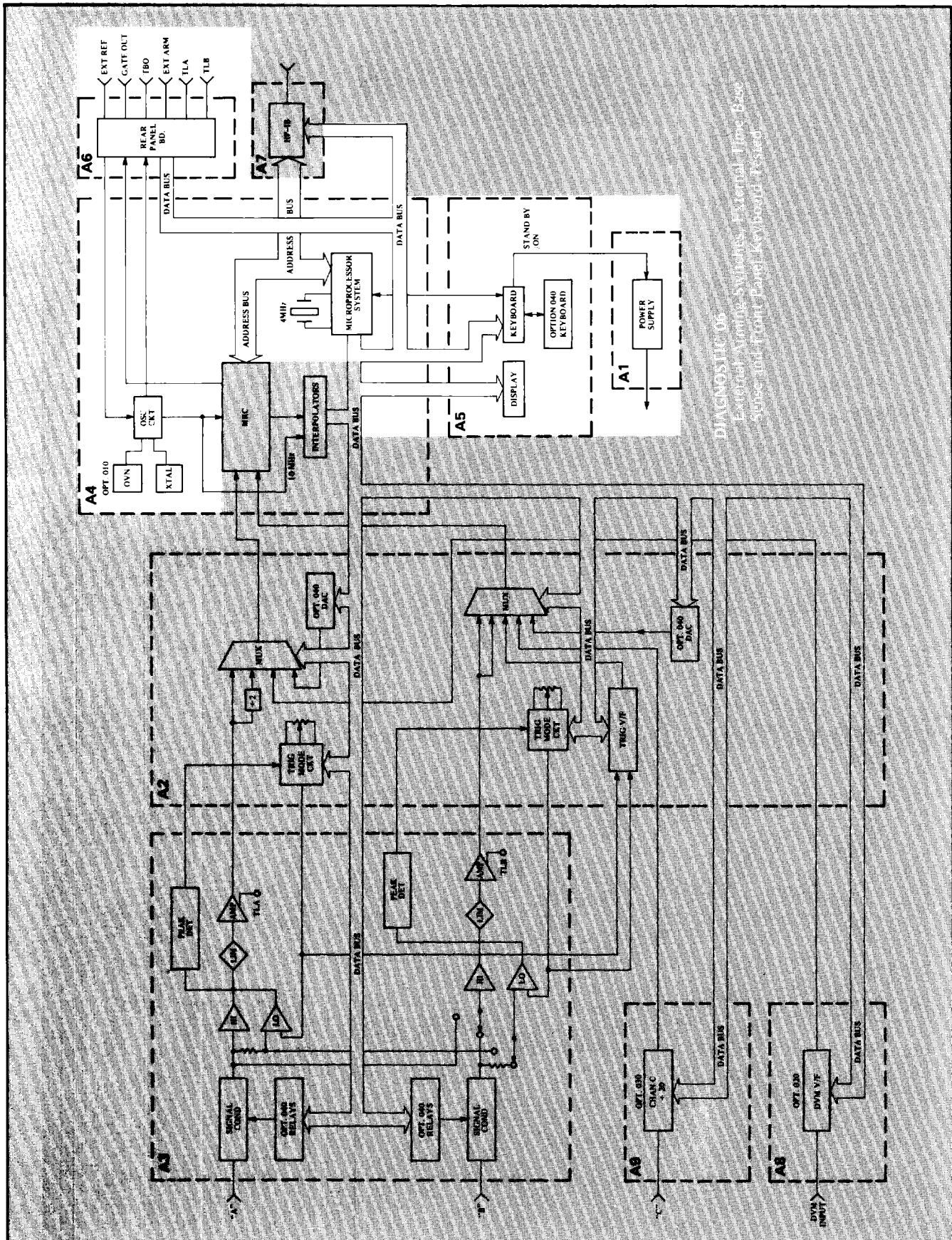

DIAGNOSTIC 06
External Alarm System, External Time Base
Subsystem Front Panel/Keyboard System

Figure 8-7. Diagnostic 06

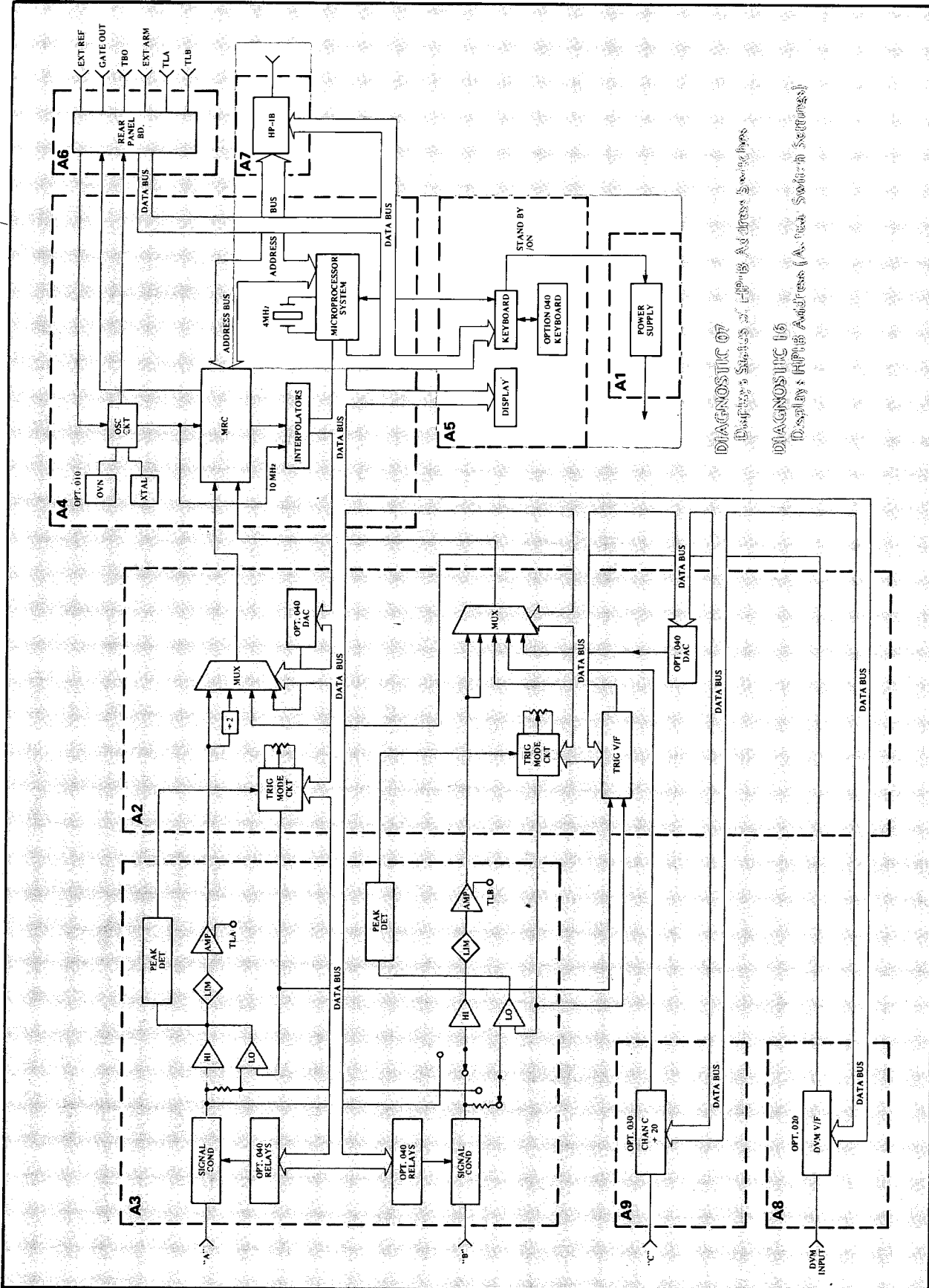

Figure 8-8. Diagnostics 07 and 16

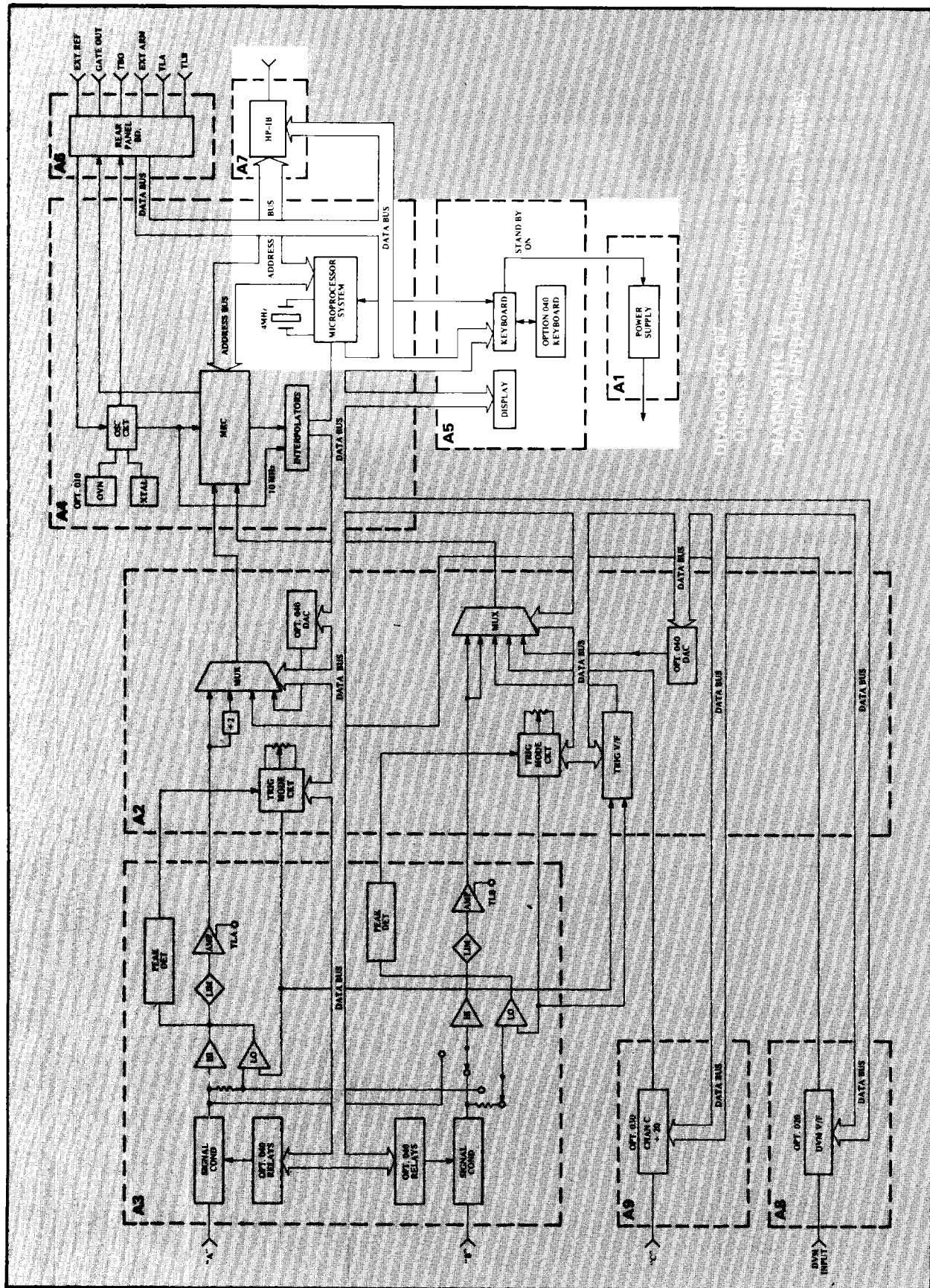

Figure 8-8. Diagnostics 07 and 16

8-146. DIAGNOSTIC #9: MRC SHORT TEST

8-147. This diagnostic does a check of the Multiple Register Counter (MRC) and the Time Base, without testing the overflow network. The MRC status is checked at various points of a measurement. The contents of the MRC's "E" and "T" registers are tested to see if they match under check measurement tolerances. The absolute value of the time base count is also checked. The 5335A will display messages "FAIL 4.1 → 4.6" if any of the tests fail. See *Table 4-3* for Fail Messages. A "PASS" message will be displayed if all tests are within limits.

8-148. DIAGNOSTIC #10: MRC EXTENDED TEST

8-149. This diagnostic does a basic check of time base and the MRC as in Diagnostic #9. Additionally, an extended test of the MRC is done by checking the slower decades and the overflow network. Failure message 4.7 → 4.9 may be displayed during this subroutine. This diagnostic routine takes about 10 seconds. If the MRC tests are within limits, a "PASS" message will be displayed.

8-150. DIAGNOSTIC #11, #12 AND #13: INTERPOLATOR COUNTERS TEST

8-151. These diagnostic subroutines are designed to aid in the troubleshooting of the START and STOP interpolators: A4U5, U8, U4, U13, U14, U9, the Current Sources (U31A and B) plus related circuitry. Short and long calibrating pulses are used to set up the interpolators for troubleshooting. Diagnostic #11 is set up with a long calibrating pulse and it is cycled as fast as possible for better oscilloscope viewing. While in this subroutine, the 5335A will display: "DIAG 11".

8-152. Diagnostic #12 is set up with a short calibrating pulse. The contents of the interpolator counter will be displayed; two 3-digit numbers will be representing the START count (left number) and the STOP count (right number). Both numbers should be similar (± 10 counts).

8-153. Diagnostic #13 is similar to Diagnostic #11, but when in this subroutine the contents of the interpolator counters are displayed. The numbers displayed should be approximately 26 to 86 counts less than the numbers displayed in Diagnostic #12.

8-154. See *Table 8-9, Troubleshooting the Interpolators*, for typical waveforms.

8-155. DIAGNOSTIC #14: FRONT END CHECK

8-156. This diagnostic subroutine is designed to check out the 5335A front end circuitry with a 10 MHz signal applied to INPUT A. Connect the rear panel TBO, (or an external 10 MHz sine wave at $\approx 1V$ rms) to INPUT A. When Diagnostic #14 is keyed up, the following sequence of tests will be performed automatically:

- a. Presence of the signal in Channel A (if no signal, ERROR 7.0 is displayed)
- b. Accuracy of the signal in Channel A (FAIL 7.1 if wrong frequency)
- c. Check Channel B for Cross Talk (FAIL 7.2 if 10 MHz is detected in Channel B; SEP/COM A in SEP)
- d. Presence of signal in Channel B (FAIL 7.3 if no trigger through COM A)
- e. Accuracy of signal in Channel B (FAIL 7.4 if wrong frequency)
- f. Check Channel A prescaler (A2U11 and U7) (FAIL 7.5 if malfunctioning)
- g. A "FE PASS" message will be displayed if all of the above tests are successfully completed.

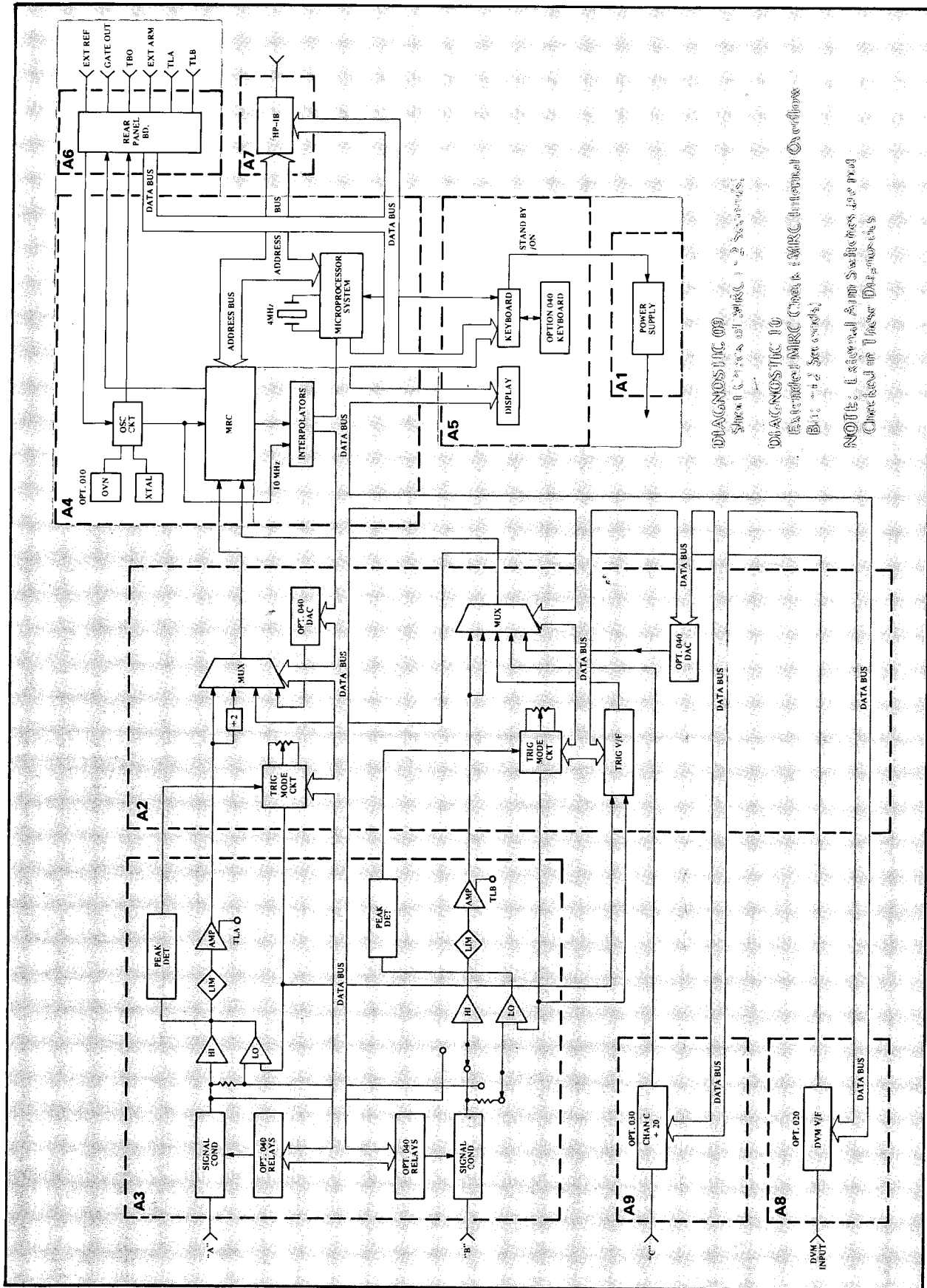

DIAGNOSTIC 09
 SHOWS TESTS OF SWR, I & S SYSTEMS
 DIAGNOSTIC 10
 EXTENDED MRC CHECK & MRC INTERNAL OVERVIEW
 BUT NOT SEQUENTIAL
 NOTE: Several Jump Switches are not
 Checked up These Data buses

Figure 8-9. Diagnostics 09 and 10

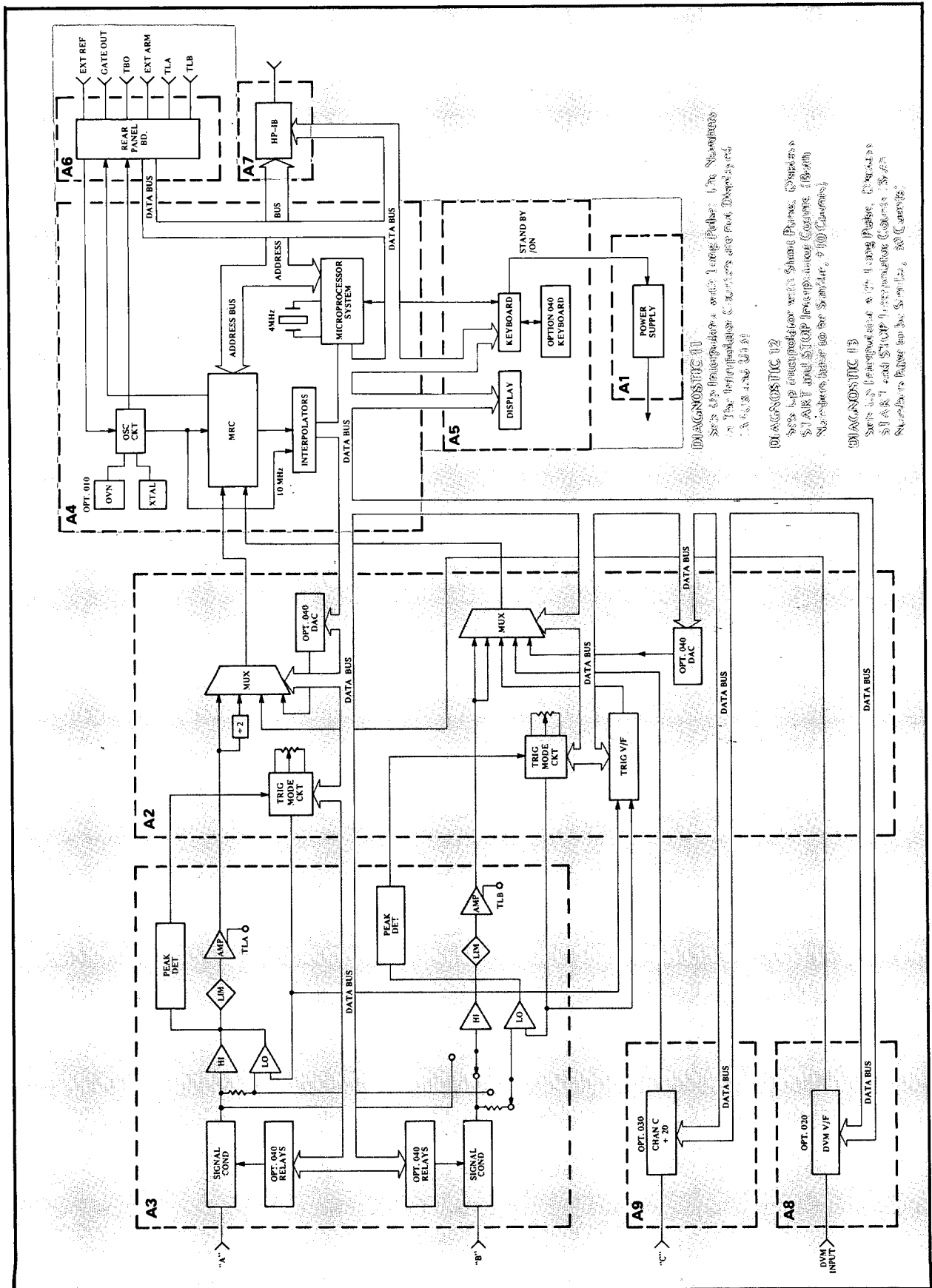

Figure 8-10. Diagnostics 11, 12 and 13

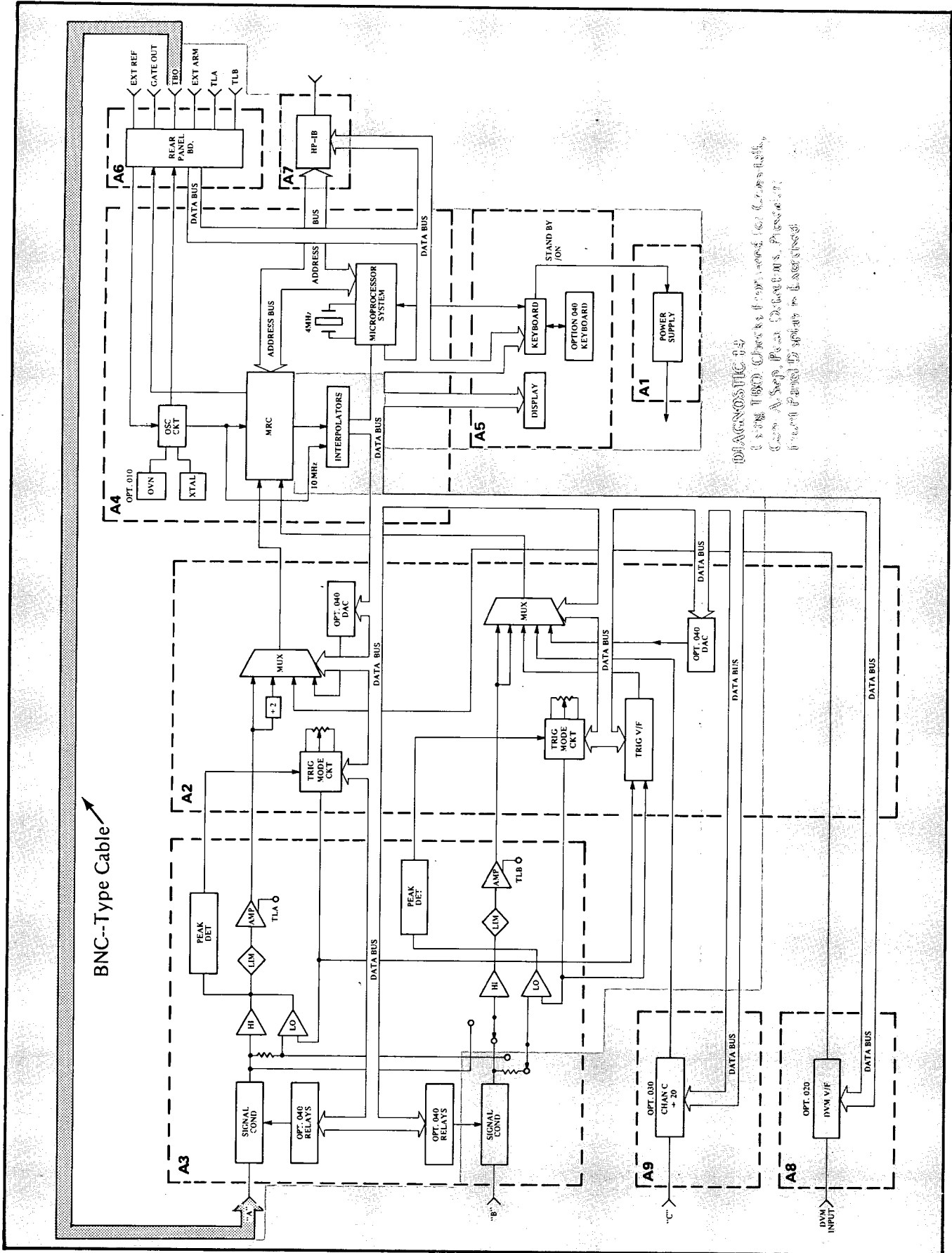

Figure 8-11. Diagnostic 14

8-157. DIAGNOSTIC #15: FRONT PANEL DISPLAY TEST

8-158. This diagnostic subroutine turns on all of the 5335A front panel display LED's, including the annunciators and the momentary switches. The Channel A and B trigger lights and the standby (STBY) LED are not tested. When Diagnostic #15 is keyed up, verify that all the indicated LEDs light up.

NOTE

The display may flicker a bit. This is due to the fact that the circuitry is being continuously written to by the μ P.

8-159. DIAGNOSTIC #16: HP-IB ADDRESS SWITCH

8-160. This diagnostic will check the status of the HP-IB address switches, similar to Diagnostic #7. This routine, however, decodes this information and displays a decimal HP-IB Bus address (i.e. HP-IB Addr 28). While in this subroutine, any change in the setting of the switches will be immediately decoded and the corresponding HP-IB Bus address will be displayed.



8-161. DIAGNOSTIC #17: KEYBOARD CHECK

8-162. This diagnostic subroutine is designed to verify the ability of the microprocessor to identify an individual software-read front panel momentary switch when it is pressed. When Diagnostic #17 is keyed up, a number should be displayed when any switch is pressed corresponding to *FIGURE A* below. The selected key's LED will remain ON while the number is being displayed. A "+ 0" will be displayed in the exponent section of the display during the test. To exit this diagnostic, the 5335A Power Switch must be cycled to STBY and back ON.

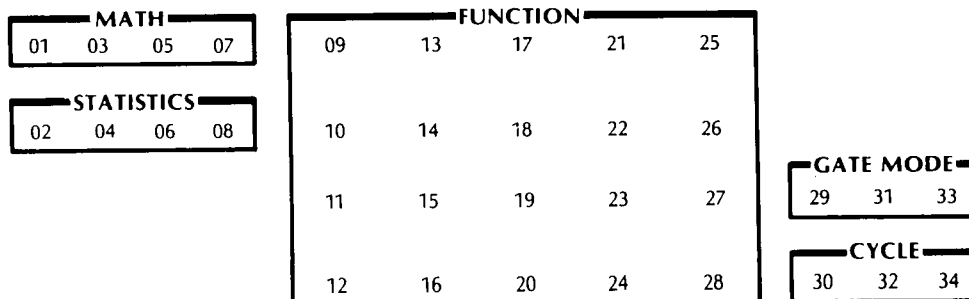

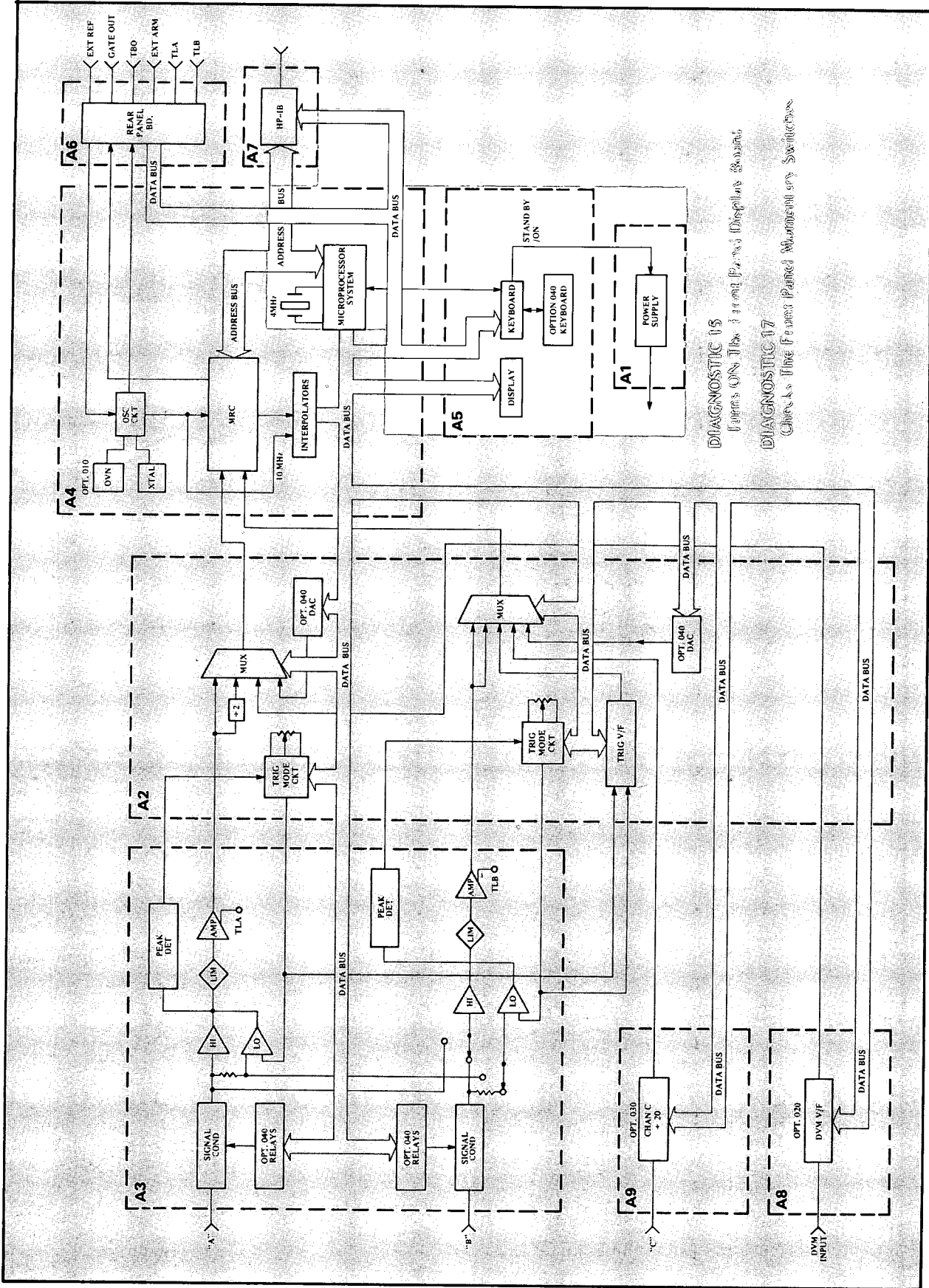

Figure 8-12. Diagnostics 15 and 17

8-163. DIAGNOSTIC #18 AND #19: DAC ADJUSTMENT (OPTION 040)

8-164. These diagnostic subroutines are designed to set up the trigger level DAC's (A11U23 and A11U21), for adjustment. These DAC's are on A11 Assembly of the 5335A option 040 programmable front end.

8-165. When Diagnostic #18 is keyed up, this subroutine programs the Channel A and B trigger level DAC's to "0" volts.

8-166. When Diagnostic #19 is keyed up, this subroutine programs the Channel A and B trigger level DAC's for "-5.12" volts.

8-167. DIAGNOSTIC #20, #21 AND #22: DVM REFERENCE TEST (OPTION 020)

8-168. These diagnostic subroutines are designed to set up the DVM option to measure and display the voltage and frequency of the -5V, GND and +5V references. These subroutines verify all the A8 DVM circuitry, with the exception of A8U11.

8-169. When Diagnostic #20 is keyed up, with the "RANGE HOLD" OFF, the 5335A will display the voltage of the -5V reference. With "RANGE HOLD" ON, the corresponding -5V reference frequency will be displayed. (This is true for all diagnostics that read in volts.) In the same manner, Diagnostics #21 and #22 measure and display the voltage and frequency of the GND (0.00V) and +5V references. Refer to the following table for expected results:

	DIAGNOSTIC		
	20	21	22
RANGE HOLD OFF	-5.00000V	0.00000V	+5.00000V
RANGE HOLD ON	900 Hz-V	6.1 kHz-V	11.3 kHz-V

8-170. DIAGNOSTIC #23, #24 AND #25: DVM RANGE TEST (OPTION 020)

8-171. These diagnostic subroutines force the DVM option into its LOW, MED, and HIGH range, respectively. By inputting a known dc voltage to the DVM input, the input amplifier A8U11, the FET's and transistor, which select the different ranges, can be tested. The autorange feature of the DVM is disabled in these tests.

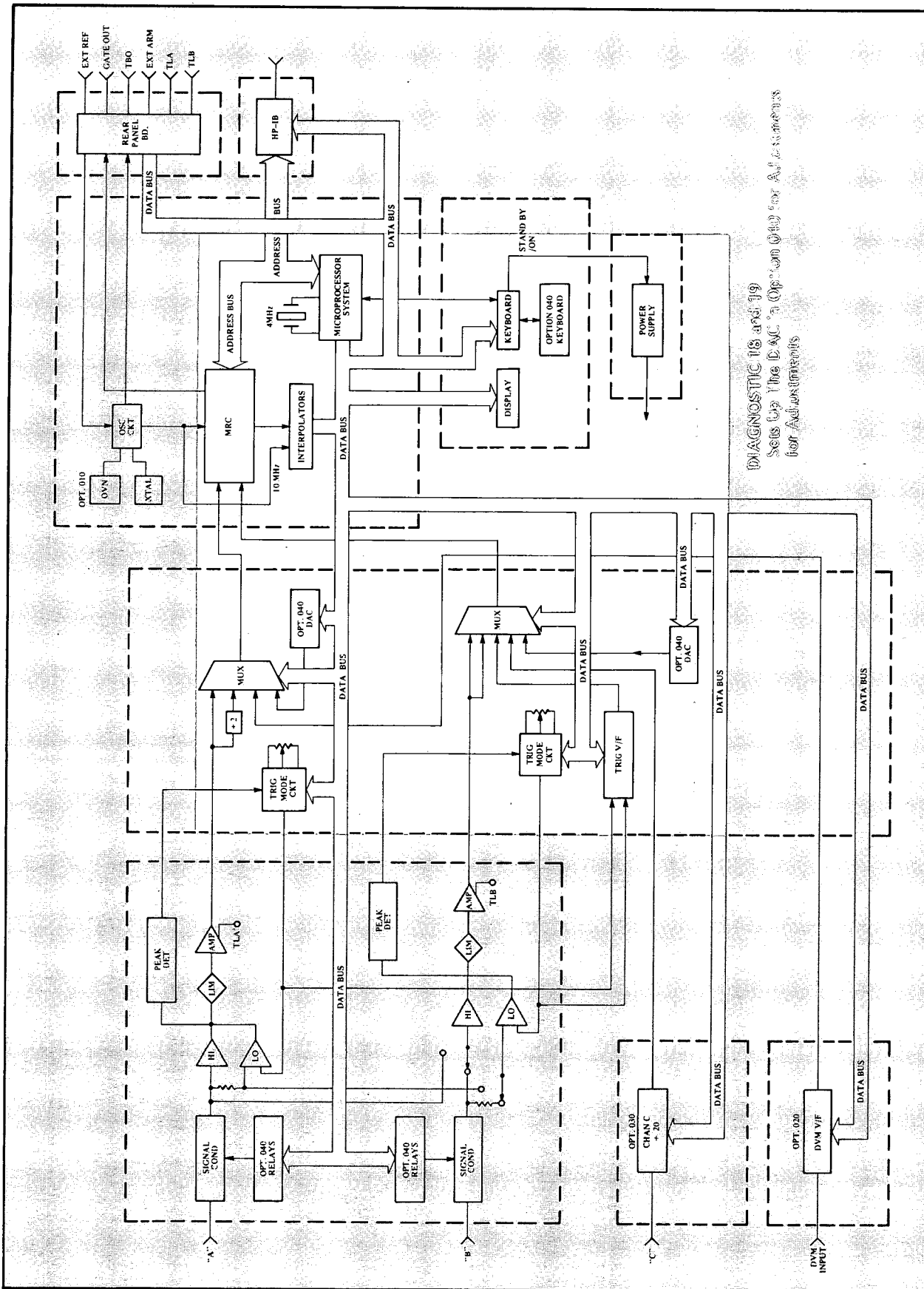

Figure 8-13. Diagnostics 18 and 19

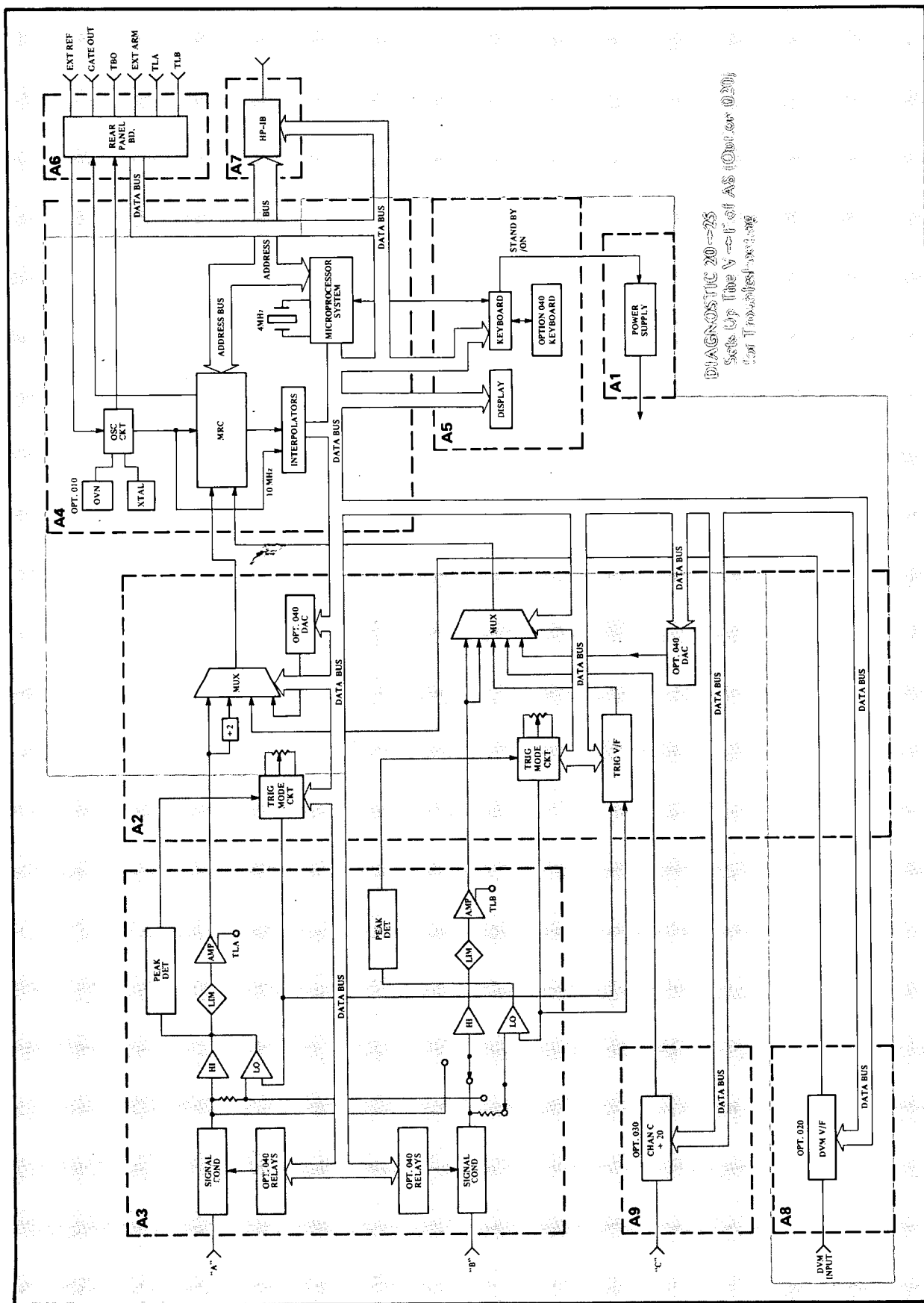

Figure 8-14. Diagnostics 20 through 25

8-172. DIAGNOSTIC #26, #27 AND #28: TRIGGER LEVEL DVM REFERENCE TEST

8-173. These diagnostic subroutines set up the trigger level DVM in the A2 amplifier support assembly so that the -5 volt, GND, (0.0 volt) and +5 volt reference voltages and frequencies can be measured and displayed. These subroutines operate the same as Diagnostics #20, #21 and #22. Diagnostic #26 programs the A4U4 multiplexer to read the -5V reference; Diagnostics #27 and #28 program the multiplexer to read the ground and +5 references respectively. A4U14, U15, U16, U4, U8, U9 and U7 are exercised with these subroutines. Results:

	DIAGNOSTIC		
	26	27	28
RANGE HOLD OFF	-5.00000V	GND REF	+5.00000V
RANGE HOLD ON	190 Hz-V	1.9 kHz-V	3.7 kHz-V

8-174. DIAGNOSTIC #29 AND #30: TRIGGER LEVELS A AND B TEST

8-175. These diagnostic subroutines are similar to Diagnostic #26 through #28, except that the actual trigger level voltage for both Channels A and B can be varied over the entire range during this exercise. Again, the corresponding frequency for a given voltage can be displayed by activating "RANGE HOLD".

8-176. DIAGNOSTIC #31, #32, #33: A4 DVM POWER SUPPLIES TEST

8-177. These three diagnostics are similar to Diagnostics #26 through #28, except that the voltage and frequency of the three power supplies are measured and displayed. Diagnostic #31 measures the +5 volt supply, #32 measures the +3 volt supply, and #33 measures the -5.2 volt supply. Pressing "RANGE HOLD" will display the corresponding frequencies. Results:

	DIAGNOSTICS		
	31	32	33
RANGE HOLD OFF	+5.00000V	+3.00000V	-5.20000V
RANGE HOLD ON	3.75 kHz-V	3.05 kHz-V	100 Hz-V

8-178. DIAGNOSTIC #34: INCREMENTAL TESTING OF THE DAC'S (OPTION 040)

8-179. This diagnostic subroutine programs the DAC's in the option 040 to step through their voltage range (from -5.11V to +5.11V) in increments of 10 mV. This subroutine performs a "functional" test on the DAC, verifying its proper operation. A visual check on the functioning of the DAC can be obtained by connecting Trigger Level A (or B) from the 5335A rear panel to an oscilloscope. The level will vary from -5.11 volts to +5.11 volts continuously. This subroutine exercises the data latches A11U16, 17 and 24, the DAC's A11U21 and U23, and the multiplexer A11U5, plus associated circuitry. When this diagnostic is accessed the 5335A will display: "DIAG 34".

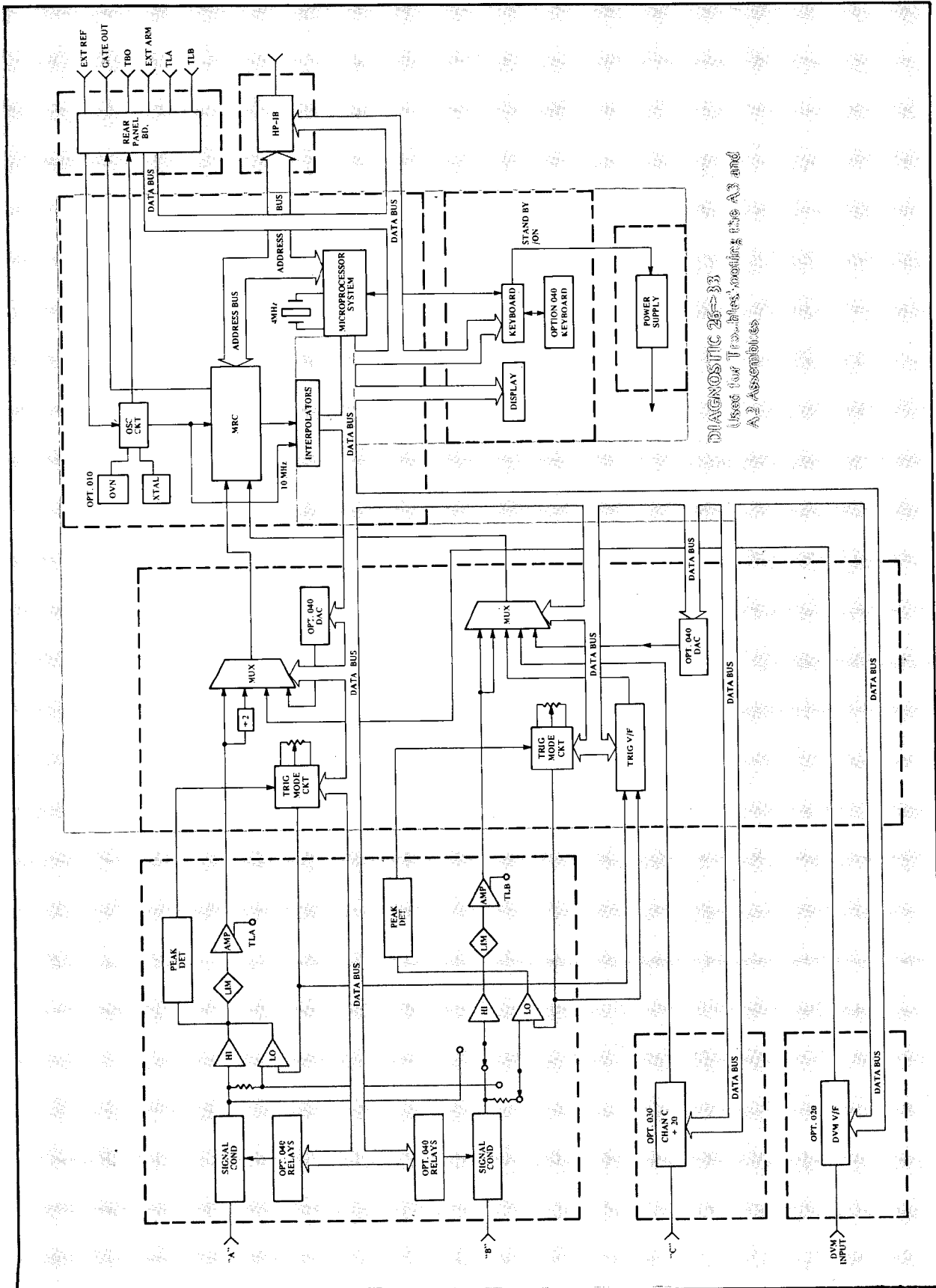

DIAGNOSTIC 26-33
Used for Troubleshooting the A3 and A3 Assemblies

Figure 8-15. Diagnostics 26 through 33

CAUTION

Before switching on the instrument, ensure the following:

- 1. The transformer primary is matched to the available line voltage.**
- 2. The correct fuse is installed.**
- 3. All safety precautions have been observed.**

For details see Power Requirements, Line Voltage Selection, Power Cables, and associated warnings and cautions in Section II of this manual.

A. POWER-UP/SELF-CHECK

First it is necessary to verify the proper operation of the **KERNEL**. The **KERNEL** is the heart of the system, the minimum hardware that must be functioning properly to operate the system. The **KERNEL** of the 5335A Universal Counter is the microprocessor (A4U28), the ROMS (A4U22 & A4U23), the RAMS (A4U25 & A4U26), the bi-directional buffers (A4U16 & A4U24), and the buffer (A4U27).

When the counter is turned on an automatic internal check is made of the **KERNEL**, the MRC (A4U6), the Start & Stop Interpolators, the A2 Voltage-to-Frequency converter, the input circuitry, the front panel keyboard and display, and the interconnecting data buses. After the power-up sequence, the counter will initialize itself. All Math and Statistics will be OFF, the function will be **FREQ A**, and the Gate and Cycle Modes will be in **NORM**. All of the input controls will be set according to their switch positions.

Any failures during the power-up cycle will disable the counter and produce one of the following:

1. A blank display.
2. A hieroglyphic is displayed.
3. Display shows a missing segment or digit.
4. Numbered **ERROR** or **FAIL** message is displayed.

Refer to *Figure 8-3 Troubleshooting Flowchart*, for further information concerning display types and possible failure messages.

Proceed with the **POWER-UP/SELF-CHECK** as follows:

1. **PRESET:** 5335A Power Switch to **STBY (OUT)**.
2. **VERIFY:** Red Standby Lamp is **ON**.
3. **SET:** 5335A Power Switch to **ON (IN)**.
4. **VERIFY:**
 - a. Red Standby Lamp is **OFF**.
 - b. All display and annunciator lamps turn on for about one second (excluding standby and trigger lamps).
 - c. Then the display shows the **HP-IB Address** for about one second.

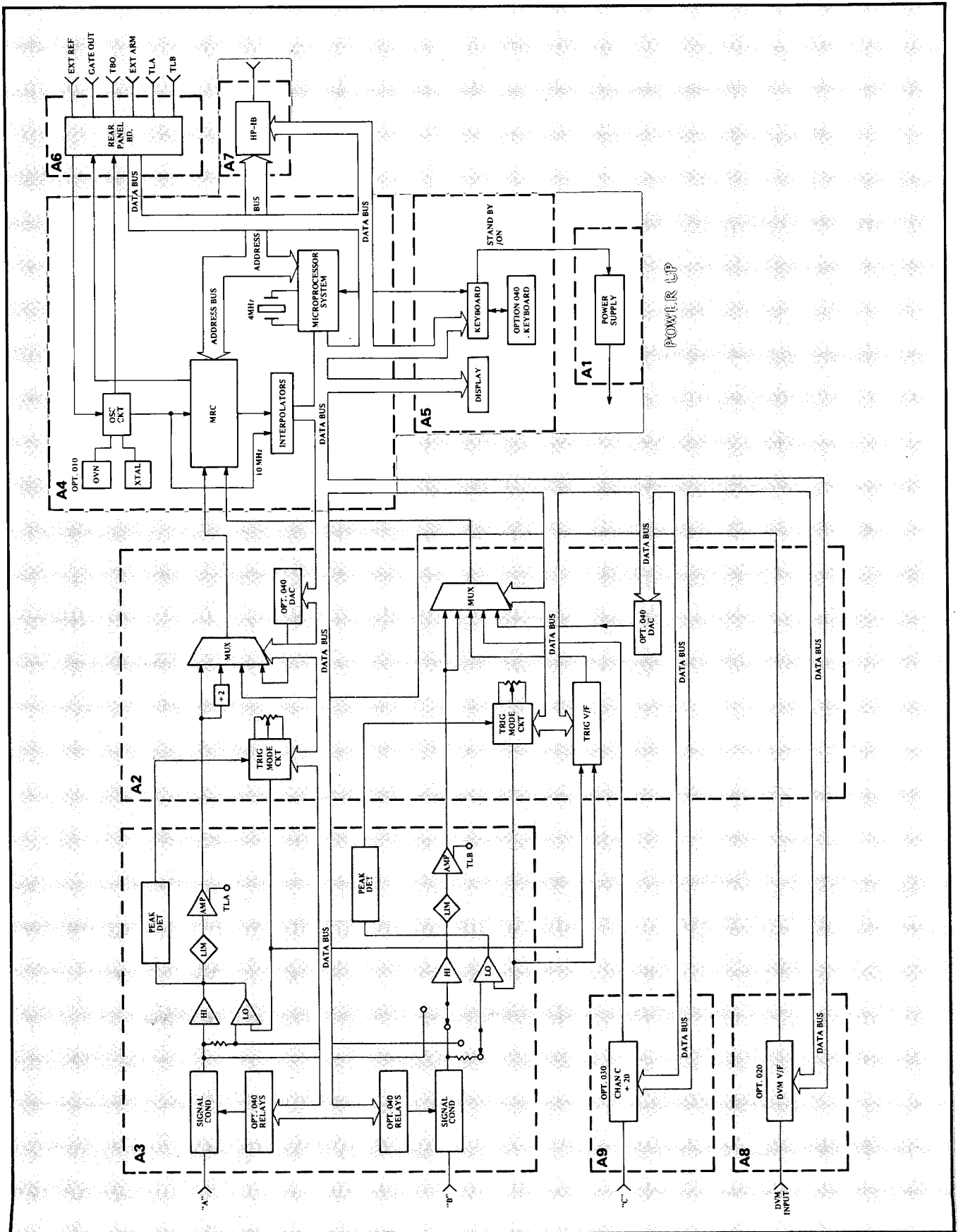

Figure 8-16. Power Up Self-Check

Table 8-3. Overall Troubleshooting (Continued)

5. Successful completion of the POWER-UP SELF-CHECK is denoted by the following:
 - a. NO FAIL or ERROR messages Displayed.
 - b. Display shows "0."
 - c. Hz lamp is ON.
 - d. FREQ A lamp is ON.
 - e. All other lamps are off (except trigger).
 - f. Fan is ON.

NOTE

If the 5335A passes the POWER-UP SELF-CHECK, proceed to SECTION IV of this manual and perform the Operational Verification in *Table 4-1*.

If a failure occurs at POWER-UP, one of the diagnostics from *Table 8-10* may be used to isolate the failure. (Refer to *Figure 8-3 Troubleshooting Flowchart*, for further information concerning display types and possible failure messages.)

First establish that the 5335A responds to the keyboard commands by pressing any one of the FUNCTION, MATH, STATISTICS, GATE MODE, or CYCLE keys. If the keyboard responds correctly the key lamp will light, with the exception of the blue MATH keys. If one of the blue MATH keys is pressed the key lamp should flash.

If the 5335A responds to the keyboard commands proceed to the SUPER CHECK. If the keyboard does not respond as indicated, proceed to *Table 8-6* for the Signature Analysis of the microprocessor.

B. SUPER CHECK (Diagnostic 01)

The SUPER CHECK is a continuous diagnostic loop which will repeat until manually reset; during this cycle the front end amplifiers are checked for accuracy, cross talk, attenuation and separate/common with the input signal. In addition the 5335A checks the operation of the following:

- ROMS
- RAMS
- DATA BUS
- FRONT PANEL DISPLAY
- MRC
- INTERPOLATORS
- TRIGGER LEVEL REFERENCES (GND, +5V, -5V)
- CHANNEL A & B TRIGGERING
- SEP/COM RELAY
- PRESALER
- POWER SUPPLY VOLTAGES (+5V, +3V, -5.2V)

NOTE

For a complete description of the SUPER CHECK refer to paragraph 8-116, and to the Diag 01 Flow Chart, *Figure 8-17*, page 8-52.

To perform the SUPER CHECK proceed as follows:

1. Connect a 4-foot BNC cable (HP P/N 10503A) from the 5335A rear panel TIME BASE OUT to the front panel INPUT A jack.

Table 8-3. Overall Troubleshooting (Continued)

2. Call up Special Function 99 by pressing the following 5335A keys:
 - a. SCALE (Verify the SCALE key lamp is flashing.)
 - b. SMOOTH (Display will show "SPECIAL +0")
 - c. 9
 - d. 9
 - e. ENTER (Display will show "DIAG 01" for about 5 sec.)

3. VERIFY:
 - a. All display annunciator lamps turn ON for about 5 sec.
 - b. Successful completion of the SUPER CHECK test loop displays the message "FE PASS" for about 15 sec.
 - c. Display shows nominal values of 3 Supply Voltages:
 - 5. 000 00 V
 - 3. 100 00 V
 - 5. 200 00 V
 - d. The test then repeats itself.

NOTE

If TIME BASE OUT is not connected to INPUT A, ERROR 7.0 will be displayed.

After successful entry into Special Function 99, any diagnostic can then be called up from the table of diagnostics (Refer to *Table 8-10*). Just press SCALE, (Verify the SCALE key lamp is flashing), the diagnostic number, and ENTER. The 5335A will access the given diagnostic.

Any failures are identified by a numbered ERROR or FAIL message. (For a description refer to ERROR/FAIL MESSAGES, paragraph 8-115.) If a failure occurs, one of the diagnostics from *Table 8-10* may be used to isolate the failure. (Refer to *Figure 8-3 Troubleshooting Flowchart*, for further information concerning display types and possible failure messages.)

C. PROCEDURE FOR INACCESSIBLE DIAGNOSTICS

If the diagnostics cannot be accessed, proceed as follows: (For example, the front panel display is blank and the 5335A does not respond to the keyboard commands.)

1. Check the Power Supplies. Refer to *Table 8-4, Power Supply Test*.
2. Check the microprocessor oscillators. Refer to *Table 8-5, Timebase and Microprocessor Oscillator Tests*. (If the supply voltages are correct, and the oscillators are operating properly, go to step 3.)
3. Check the **KERNEL** of the 5335A. Refer to *Table 8-6, Signature Analysis of the microprocessor*. This procedure is done with the microprocessor set in the FREE RUN MODE and is not dependent on the front panel display. (If the signatures in *Table 8-6* are correct, then the Address Bus is functioning properly. Proceed to step 4.)
4. Check the ROMS and the Data lines. Refer to *Table 8-7, Signature Analysis of the ROMS*. (If the signatures in *Table 8-7* are correct, the Data Bus is functioning properly. Go to step 5.)
5. Check the Keyboard and Display Assembly (A5) for open traces or open circuits, and the cable (W4) that connects the Keyboard and Display Assembly to the Main Logic Assembly (A4) for opens. (Refer to *Figure 8-22, 5335A Assembly and Cable Locator*.)

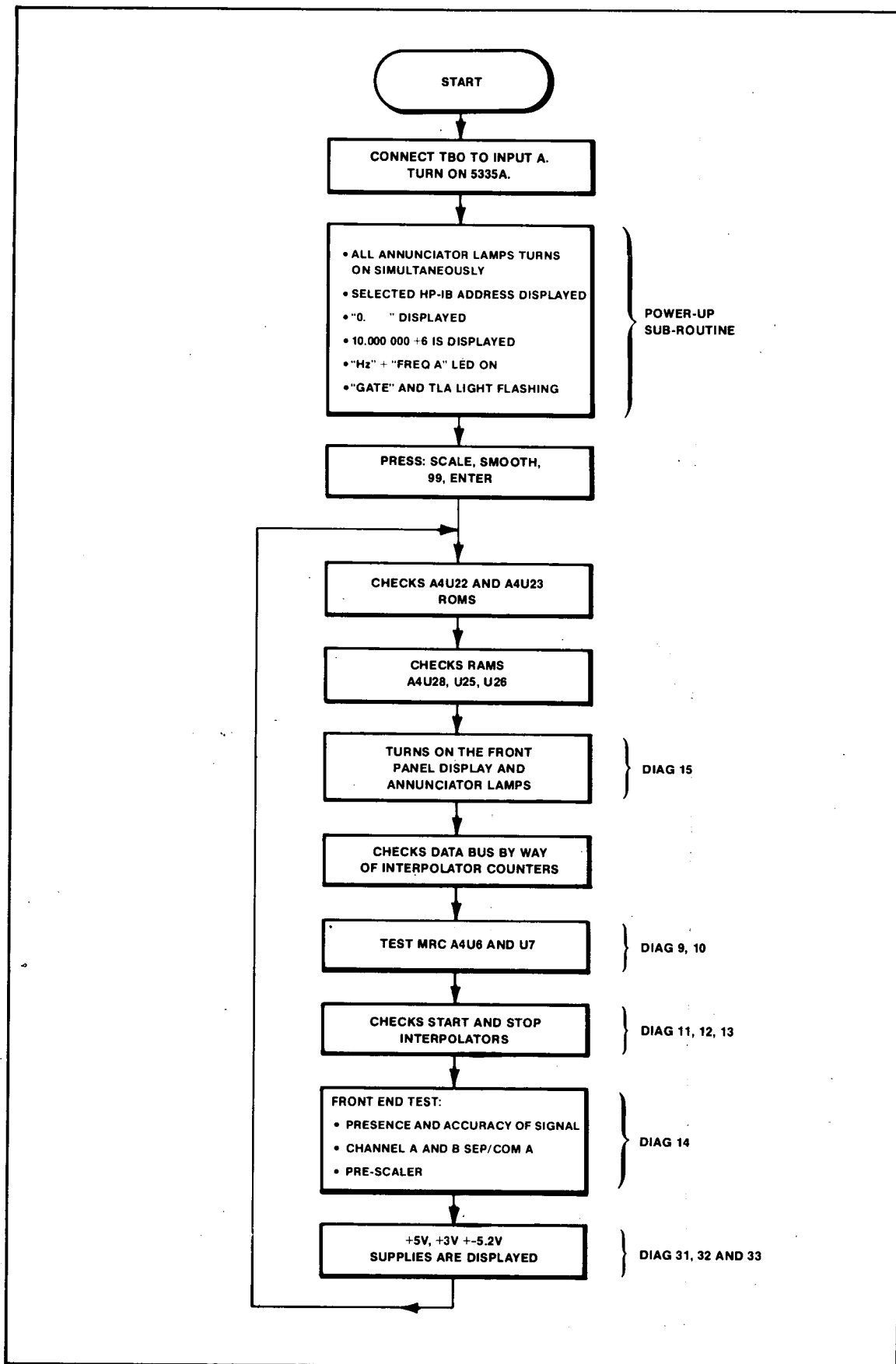

Figure 8-17. Diagnostic 01 Flowchart

Table 8-4. Power Supply Test

1. To verify proper operation of the 5335A, A1 Power Supply Assembly (05335-60001), check the seven DC voltages labeled on the A1 Power Supply board and the AC voltage on A1J1 (4,4̄). If you have option 020 (DVM Assembly 05335-60008), check the AC voltage on A1J1(4̄) going to the DVM via the A2 Assembly (05335-60002), and on the DVM board (05335-60008).
2. There are two adjustable supplies on the A1 Power Supply board, the +3.1V supply and the +15.7V supply. Make sure that all supply voltages are within tolerance.

VOLTAGE (VDC)	TOLERANCE (VDC)	ADJUSTMENT
+15.70	±0.20	A1R15
-15.00	±0.75	NONE
+10.00	±0.01	NONE
+ 5.00	±0.12	NONE
- 5.20	±0.15	NONE
+ 3.10	±0.05	A1R1
+24.50	±2.50	NONE

3. If any of the voltages are not present at the supplies, check voltages at the fuse holders and at A1CR8 (pins marked + and - on the PC board and the schematic). Refer to the A1 (05335-60001) power supply schematic for additional information. If the voltages are present at the fuse holders, but not at the supplies, suspect the A1K1 relay.
4. If any of the Power Supply voltages are low isolate the A1 Power Supply Assembly by disconnecting the following:
 - a. the Amplifier Support Assembly 05335-60002 (A2) from the Power supply Assembly (A1).
 - b. the Main Logic Assembly 05335-60004 (A4) from the Power Supply Assembly (A1) via W2.
 - c. the Keyboard and Display Assembly 05335-60005 (A5) from the Main Logic Assembly 05335-60004 (A4) via W4.
5. If the Power Supply voltages do not come back up to the specified values, troubleshoot the power supplies on A1.
6. If the Power Supply voltages come back up to the specified values reconnect (a), (b), and (c) in step (4) one at a time, checking the supply voltages on A1 after each assembly is reconnected. This will enable you to determine which assembly is loading down the supply voltages.
7. After determining which assembly is loading down the voltage, proceed to troubleshoot the faulty assembly.

Table 8-5. Timebase and Microprocessor Oscillator Tests

A. 10 MHz TIMEBASE OSCILLATOR

1. To verify the proper operation of the 10 MHz timebase oscillator (Y1) on the Main Logic Assembly (A4), and the associated circuitry, check for the presence of the 10 MHz signal at Test Point marked "CLK" [same as A4U6 (21)], and compare with the following typical waveform in Figure 8-4:

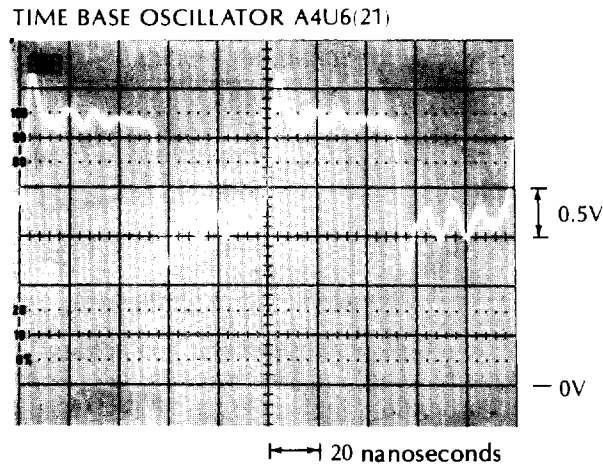

Figure 8-18. 10 MHz Timebase Oscillator Signal

2. If the internal 10 MHz signal is not present at test point "CLK", or A4U6(21), backtrace to determine if the signal is present at A4Y1, A4U2B, and A4U1.
3. If the option 010 ovenized oscillator is installed, and the 10 MHz signal is not present at test point "CLK" or A4U6(21), check to see if the signal is present at A4U1(6). If the 10 MHz signal is not present at A4U1, check the voltage regulator (A4U29) for +12.15V at pin (1), and +24.5V at pin (3). If the voltages are present at A4U29 (1 and 3), suspect the ovenized oscillator.

B. 4 MHz MICROPROCESSOR OSCILLATOR

1. Verify that the 4 MHz Microprocessor Oscillator signal is present at A4U28(38) and compare with the following typical waveform shown in Figure 8-5:

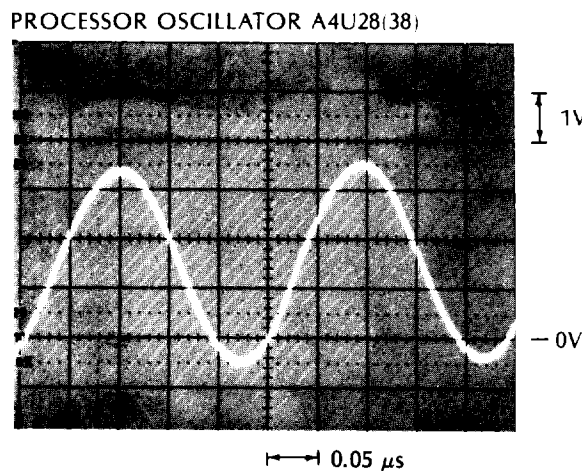

Figure 8-19. 4 MHz Microprocessor Oscillator Signal

Table 8-5. Timebase and Microprocessor Oscillator Tests (Continued)

2. If the 4 MHz signal is not present at A4U28(38), suspect A4Y2. If the 4 MHz signal is present, verify that the 1 MHz signal at A4U28(37) is present and that it is similar to the following waveform in Figure 8-6:

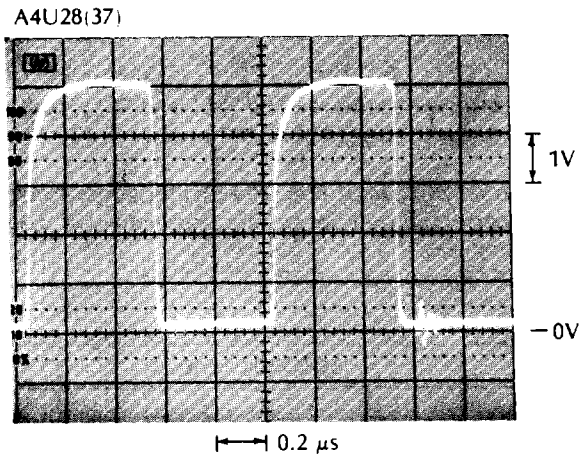

Figure 8-20. 1 MHz Microprocessor Oscillator Signal

3. If the 1 MHz signal is not present at A4U28(37), suspect A4U28.

Table 8-6. Signature Analysis of the Microprocessor

This procedure is designed to test the μ P (A4U28) and its associated hardware. The circuitry is tested using signature analysis with the μ P in the FREE RUN mode.

1. Connect the Signature Analyzer START, STOP, and CLOCK leads to the appropriate test pins next to the A4U28 Microprocessor. Set the START, STOP, and CLOCK keys on the Signature Analyzer to the negative edge (\overline{f}). Ensure that the Signature Analyzer CLOCK Pod lead is connected to the test pin marked "CK1".
2. Connect a jumper between the test points marked "SA" and "G", located between A4U12 and A4U21. This will set the Microprocessor in the "FREE RUN" mode.
3. Press the 5335A power key to STBY then ON. The first signature to be verified is the +5V signature (0003). If this signature is correct, it signifies proper connection of the signature analyzer.
4. Verify the following A4U28 Signatures:

PIN#	ADDRESS LINE	SIGNATURE
9	0	UUUU
10	1	FFFF
11	2	8484
12	3	P763
13	4	1U5P
14	5	0356
15	6	U759
16	7	6F9A
17	8	7791
18	9	6321
19	10	37C5
20	11	6U28
22	12	4FCA
23	13	4868
24	14	9UP1
25	15	0001

5. Verify the following associated hardware KEY signatures:

DEVICE#	U10	U11	U12	U19	U20	U21
PIN#	SIGNATURES					
1	9AAC	P50C		FFFF		
2	0356	4868		8484		
3	U759	9UP1	4FCA	P763		0000
4	5434		4FC9	0000		
5	2002		01H7	PU4A		
6	PU4A		099C		3714	0003
7	01H4					
8		0000	099C		48C7	0000
9	3282	01H4	01H7	7FH1		
10	AH63	01H7		FH24		
11		4FCA		H27U		0003
12		6F9A		27F0	9AAC	
13	9UP1	UHU5		7F30		
14	4868	0003		F33U		
15	0000			33F2		
16	0003					

Table 8-6. Signature Analysis of the Microprocessor (Continued)

6. Verify the following signatures on A7 (HP-IB Logic Assembly). Ensure the Signature Analyzer CLOCK (CK1), START and STOP keys are negative (\bar{F}).

TEST POINT	SIGNATURE
A7U1(4)	P546
A7U2(5)	U867
A7U2(11)	7APA

7. If the above signatures are correct at the specified key points, proceed to Table 8-7 for the Signature Analysis of the ROMS.

Table 8-7. Signature Analysis of the ROMS

This procedure is designed to test the ROMS (A4U22 and A4U23) using signature analysis, with the μP set in the FREE RUN mode.

1. Connect the Signature Analyzer START and STOP leads to the appropriate test pins next to the A4U28 microprocessor, marked "S". The CLOCK Pod lead should be connected to the test pin marked "CK2" (located next to A4U23) when testing A4U23, and to "CK3" (located next to A4U22) when testing A4U22.

2. Set the Signature Analyzer keys as follows:

START and STOP (neg.) \bar{L}
 CLOCK (pos.) F

3. Connect a jumper between test points marked "SA" and "G", located between A4U12 and A4U21. This will set the processor in the "FREE RUN" mode.
4. Verify the following signatures on the A4U23 ROM. Ensure the Signature Analyzer CLOCK (CK2) key is set (F) positive, and the START and STOP keys are set negative (\bar{L}).

PIN#	DATA LINE	SIGNATURE
9	0	F847
10	1	UP57
11	2	C058
13	3	3867
14	4	2C79
15	5	08C4
16	6	FP12
17	7	5770

5. Verify the following signatures on the A4U22 ROM. Ensure the Signature Analyzer CLOCK (CK3) key is set positive (F), and the START and STOP keys are set negative (\bar{L}).

PIN#	DATA LINE	SIGNATURE
9	0	964C
10	1	1F42
11	2	5A38
13	3	F9A5
14	4	U94H
15	5	11F0
16	6	C1C3
17	7	2PA0

6. If the signatures are correct, proceed to Table 8-8 for the Signature Analysis of the output ports in "STIMULUS" mode. If any signatures are incorrect, suspect a faulty data bus (check for shorts), (A4U10) the 2-4 decoder, (A4U12A and A4U12E) the inverters, (A4U21 and A4U24) the Bidirectional buffers, (A4U27) buffer or (A4U28) the microprocessor.

Table 8-8. Signature Analysis of the Output Ports

Diagnostic #2 is designed to test all output ports. The circuitry is tested using signature analysis with the 5335A set in the STIMULUS MODE. To avoid "PILOT ERROR" in setting up the diagnostic, the input ports are not tested. The output ports tested in this procedure are:

1. Gate Range/Output control Flip Flops (A4U17 and A4U18)
2. Keyboard/Display control latch (A5U4)
3. Keyboard/Display Data latch (A5U5)
4. HP-IB Data Output Ports (A7U1, A7U4, A7U7 and A14J3)
5. DVM option control latch (A8U3)

One of the following two methods can be used to enable Diagnostic #2:

1. By software: If the processor can communicate with the keyboard, press: SCALE, SMOOTH, 99, ENTER. Wait 5 seconds, press: SCALE, 2, ENTER. The 5335A will display "DIAG 02", enabling the stimulus mode.
2. By hardware: Press the 5335A Power Switch to STBY. Place A6 on the HP-IB Address Switch (A14S1A6) in the "1" position (UP). Connect a jumper between the two plated-through holes marked "1" located between A14J2 and A14S1 (marked "SW1"). Press the 5335A Power Switch ON. If the jumper has been connected properly all display annunciator lamps will turn ON and stay ON, enabling the stimulus mode.

After the 5335A has been set in the STIMULUS MODE:

1. Connect the Signature Analyzer START, STOP, and CLOCK leads to the appropriate test pins next to the A4U28 microprocessor chip. Set the START, STOP, and CLOCK keys on the Signature Analyzer to the negative edge ($\overline{\square}$). Ensure that the Signature Analyzer CLOCK pod lead is connected to the test pin marked "CK1".
2. Verify the +5V characteristic signature is 6PCU. If this signature is correct, it means the Signature Analyzer is connected properly.
3. Verify the following Key Signatures at the Output Ports:

a. Gate Range/Output control Flip Flops on A4 (Main Logic Assy):

A4U18 (9)	A95H
A4U18 (11)	9558
A4U17 (9)	A95H
A4U17 (11)	9558

b. Keyboard/Display Control Latch on A5 (Keyboard and Display Assy):

A5U4 (2,7,10,15)	1A95
A5U4 (9)	4101

c. Keyboard/Display Control Latch on A5 (Keyboard and Display Assy):

A5U5 (2,5,6,9,12,15,16,19)	F1A9
A5U5 (11)	2F44

Table 8-8. Signature Analysis of the Output Ports (Continued)

d. HP-IB Data Output port on A7 (HP-IB Logic Assy) and A14J3 (HP-IB connector):

A7U1 (29 through 36)	02A5
A7U4 (2,3,5,6,10,11,13,14)	02A5
A7U7 (2,3,5,6,10,11,13,14)	02A5
A14J3 (1 through 4 and 13 through 16)	02A5

e. DVM Option Control Latch on A8 (DVM Assy):

A8U3 (2,7,10,15)	95H2
A8U3 (9)	H0F8

4. If any of these "key-point" signatures are not correct, proceed to back-trace the signatures. Suspect the RAMS A4U25 or A4U26, the D-Flip Flops A4U17 or A4U18, or the microprocessor (A4U28). (Check for shorted components). Refer to Table 8-6 for the Signature Analysis of the microprocessor.

Table 8-9. Troubleshooting the Interpolators

Special Diagnostic subroutines #11, #12, and #13 can be used to verify the proper operation, or to troubleshoot the START and STOP interpolators in the 5335A. Proper functioning of the analog portion of the interpolators is verified by observing waveforms at key points on the Main Logic Assembly (A4).

Diagnostic #11 is used exclusively for observing the waveforms at specified key points. The numbers in the interpolator counters are not displayed. The 5335A display will show: "DIAG 11".

Diagnostic #12 displays two groups of 3-digit numbers. The number on the left side of the display shows the count in the START interpolator, and the number on the right side of the display shows the count in the STOP interpolator. Both numbers should be approximately ± 10 counts of each other.

Diagnostic #13 also displays two groups of 3-digit numbers, showing the counts in both the START and STOP interpolators. The counts displayed should be approximately 26 to 86 counts less than the counts displayed by Diagnostic #12.

NOTE

The number displayed is the interpolator count minus 256. An 8 bit counter is used as a 9 bit counter in this mode; the ninth bit is assumed.

Both Diagnostics 12 and 13 can also be used to observe waveforms at specified key points on the A4 assembly. Since the circuitry for both the START and STOP interpolators is identical, the waveforms shown apply to both circuits.

To access Diagnostics #11, #12, or #13 put the 5335A in the diagnostic mode by calling up Special Function 99. This can be done by pressing the 5335A keys: SCALE, SMOOTH, 99, ENTER. Wait 5 seconds before selecting the diagnostic, then to access one of the following diagnostics proceed as indicated:

Diagnostic #11, press: SCALE, 11, ENTER.

Diagnostic #12, press: SCALE, 12, ENTER.

Diagnostic #13, press: SCALE, 13, ENTER.

DIAGNOSTIC 11

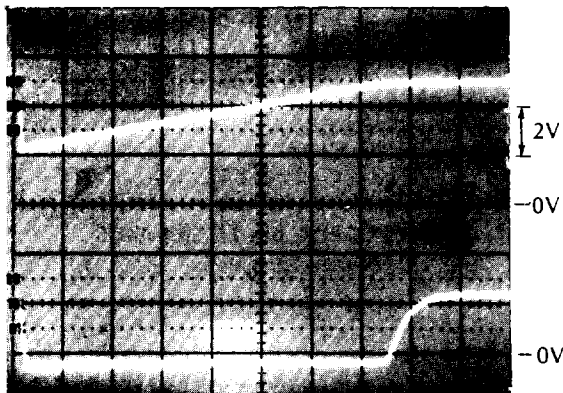

TIME BASE: X1

5 μ s

DIAG 11

TOP: Output of A4U31B, pin 6 and A4U31A, pin 13; fast and slow current sources. Check for linearity.

BOTTOM: Input of A4U5, pin 3 and A4U4 pin 3; comparator gates.

Table 8-9. Troubleshooting the Interpolators (Continued)

DIAGNOSTIC 11 A4U4(11) and U5(11)

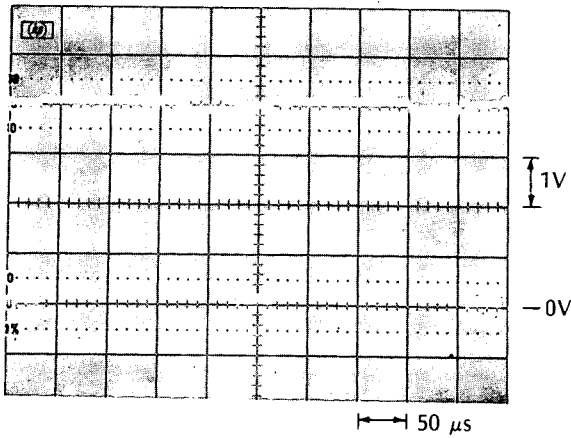

DIAG 11

Output of A4U4 pin 11, and A4U5, pin 11; comparator gates.

DIAGNOSTIC 12

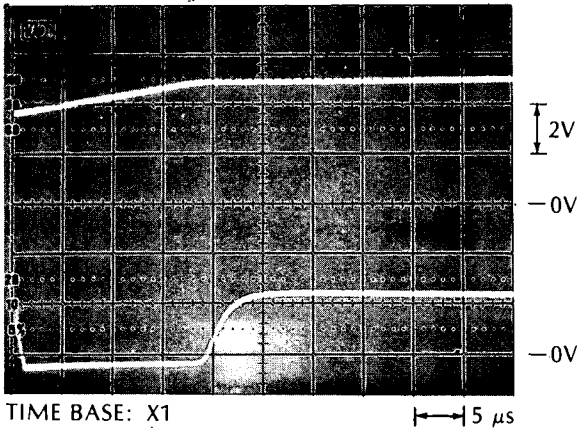

TIME BASE: X1

DIAG 12

TOP: Output of A4U31B, pin 6, and A4U31A pin 13; fast and slow current sources. Check for linearity.

BOTTOM: Input of A4U5, pin 3, and A4U4, pin 3; comparator gates.

DIAGNOSTIC 12 A4U4(11) and A4U5(11)

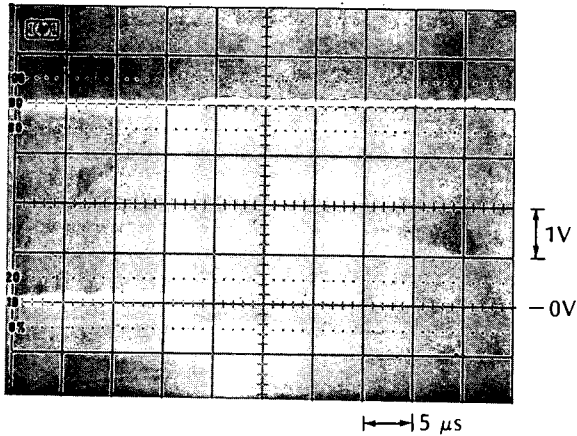

DIAG 12

Output of A4U4, pin 11, and A4U5, pin 11; comparator gates.

Table 8-9. Troubleshooting the Interpolators (Continued)

DIAGNOSTIC 13

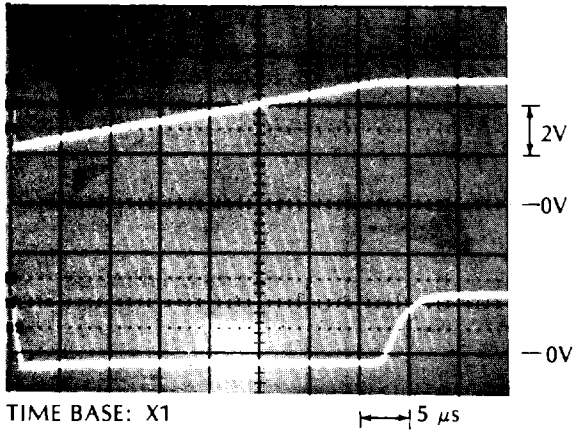

DIAG 13

TOP: Output of A4U31B, pin 6, and A4U31A, pin 13; fast and slow current sources. Check for linearity.

BOTTOM: Input to A4U5, pin 3, and A4U4, pin 3; comparator gates.

DIAGNOSTIC 13 A4U4(11) and U5(11)

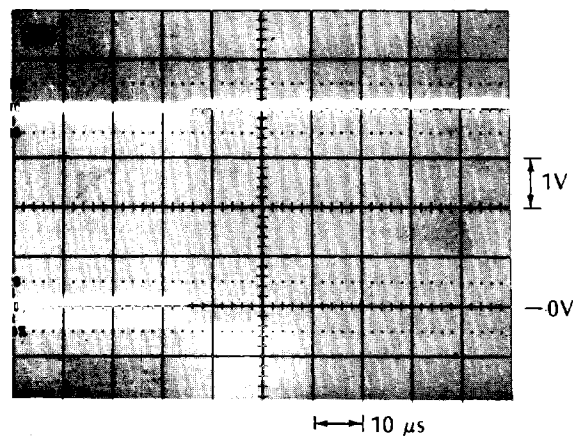

DIAG 13

Output of A4U4, pin 11, and A4U5, pin 11; comparator gates.

Table 8-10. Diagnostics

DIAGNOSTIC #	DESCRIPTION	COMMENTS
0	SUPERCHECK	
1	(SCALE = 0 AUTOSETS TO 1)	
2	STIM MODE OF SIGNATURE ANALYSIS	
3	SETS FRONT END CONTROL TO 0'S	programmable input version
4	SETS FRONT END CONTROL TO 1'S	
5	DISPLAYS FRONT END SWITCH DATA	
6	DISPLAYS REAR SWITCH GROUP DATA	
7	DISPLAYS HP-IB ADDR SWITCHES	
8	PROD TEST OF ALL SWITCHES	
9	DOES SHORT CHECK OF MRC	
10	DOES EXTENDED CHECK OF MRC	checks overflow bit
11	INTERPOLATE LONG, NO DISPLAY (FAST)	
12	INTERPOLATE SHORT, W/DISPLAY	
13	INTERPOLATE LONG, W/DISPLAY	
14	CHECKS FRONT END USING TIMEBASE OUT	
15	URNS ON ALL DISPLAY ANNUNCIATORS	
16	DISPLAYS THE HP-IB ADDRESS	
17	DISPLAYS KEY # (OPER-CODE)	
18	TWEEK DACS TO ZERO	
19	TWEEK DACS TO -5.12V	
20	DVM MUX = -5V REF	DVM V → F
21	DVM MUX = GND REF	
22	DVM MUX = +5V REF	
23	DVM MUX = INPUT, RANGE = LOW	
24	DVM MUX = INPUT, RANGE = MED	
25	DVM MUX = INPUT, RANGE = HIGH	
26	TRIG DVM = -5V REF	
27	TRIG DVM = GND REF	
28	TRIG DVM = +5V REF	
29	TRIG DVM = TRIG A INPUT	AUTO TRIG must be OUT
30	TRIG DVM = TRIG B INPUT	
31	TRIG DVM = +5 VOLT SUPPLY	
32	TRIG DVM = +3 VOLT SUPPLY	
33	TRIG DVM = -5.2 VOLT SUPPLY	
34	INCREMENTAL TESTING OF DACS	

NOTE

All DIAG volts read in (volts) with "RANGEHOLD" off and read in V/F frequency out (Hz-volts) with "RANGEHOLD" on.

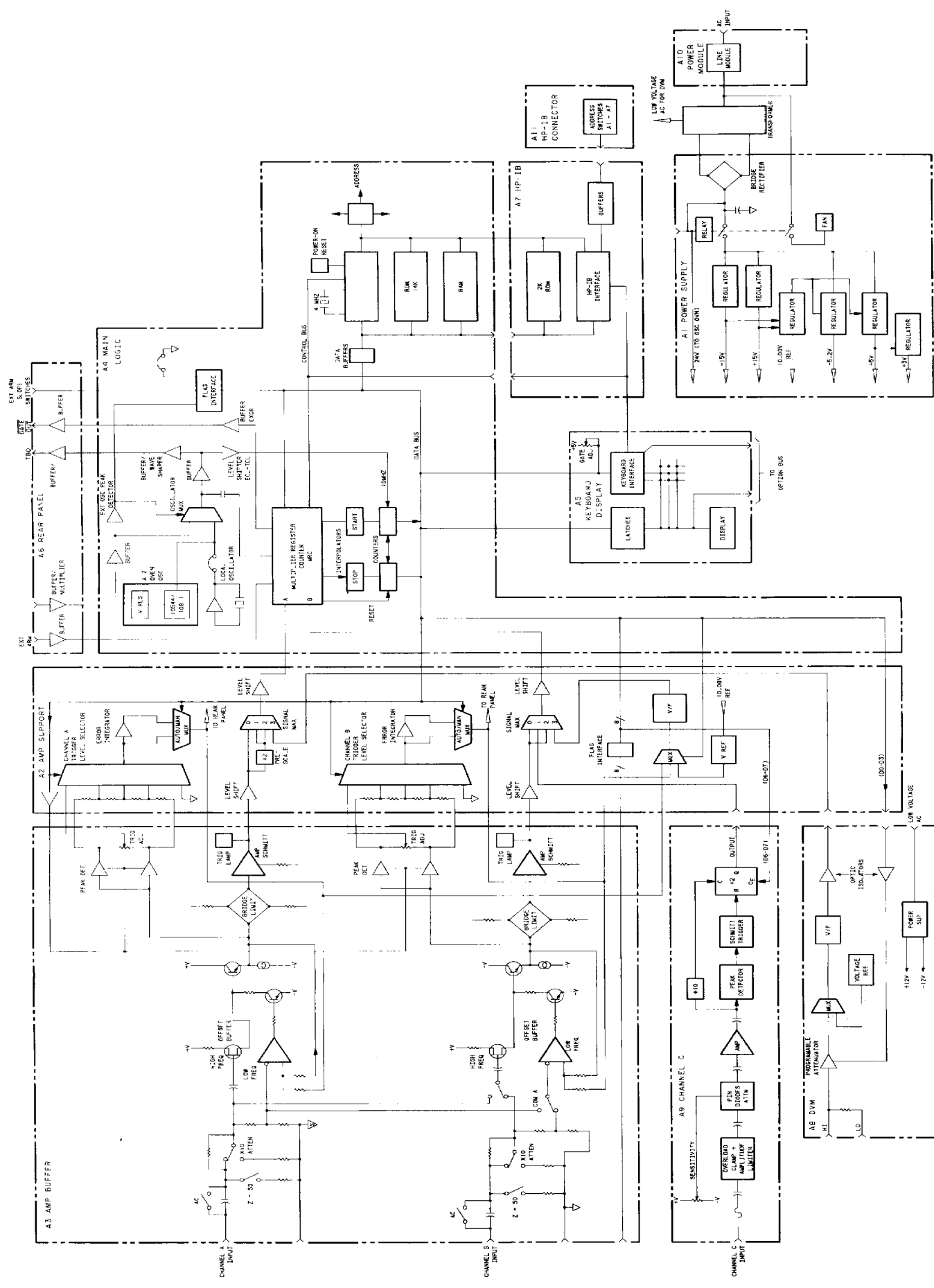

Figure 8-27. Detailed Block Diagram

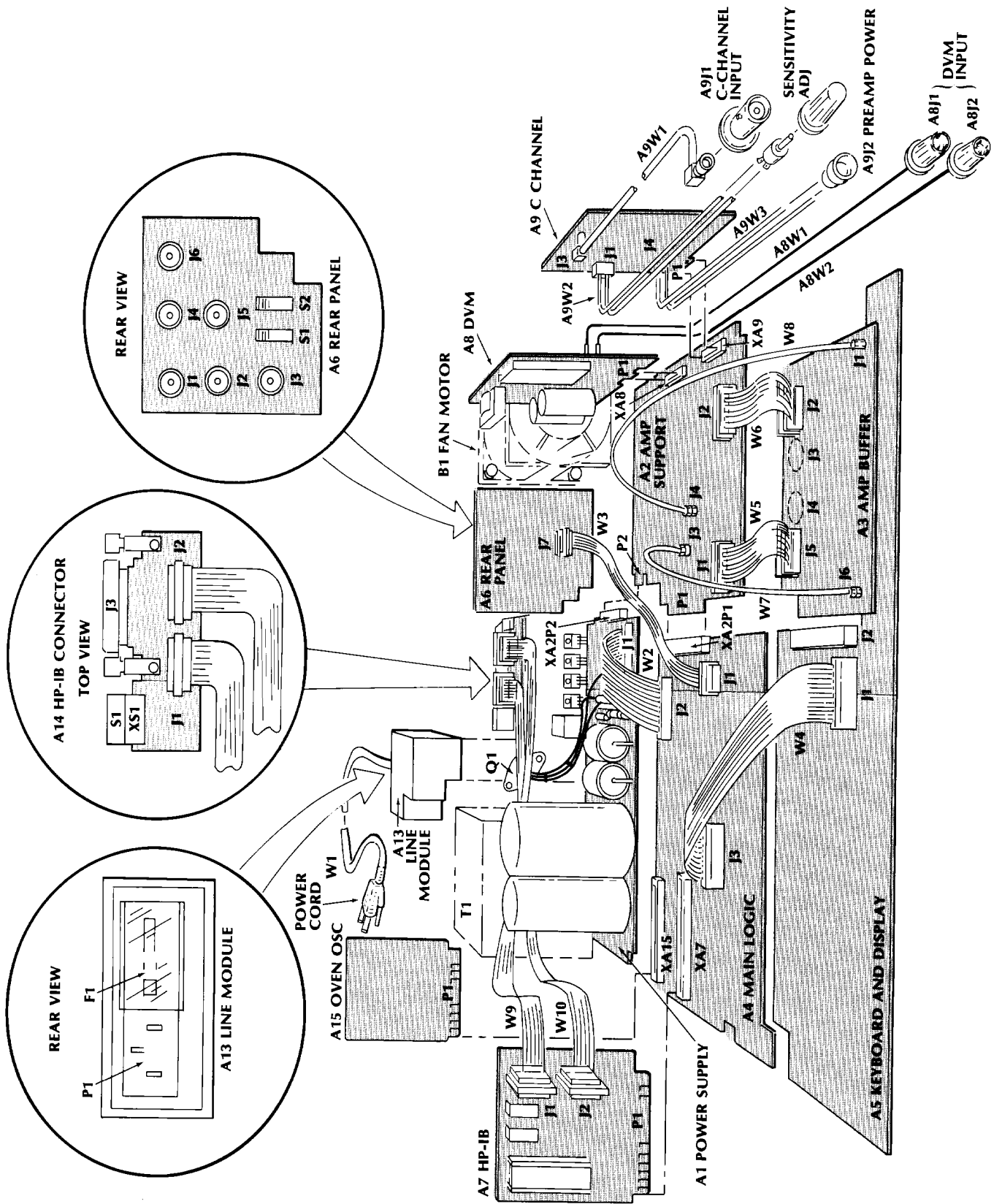
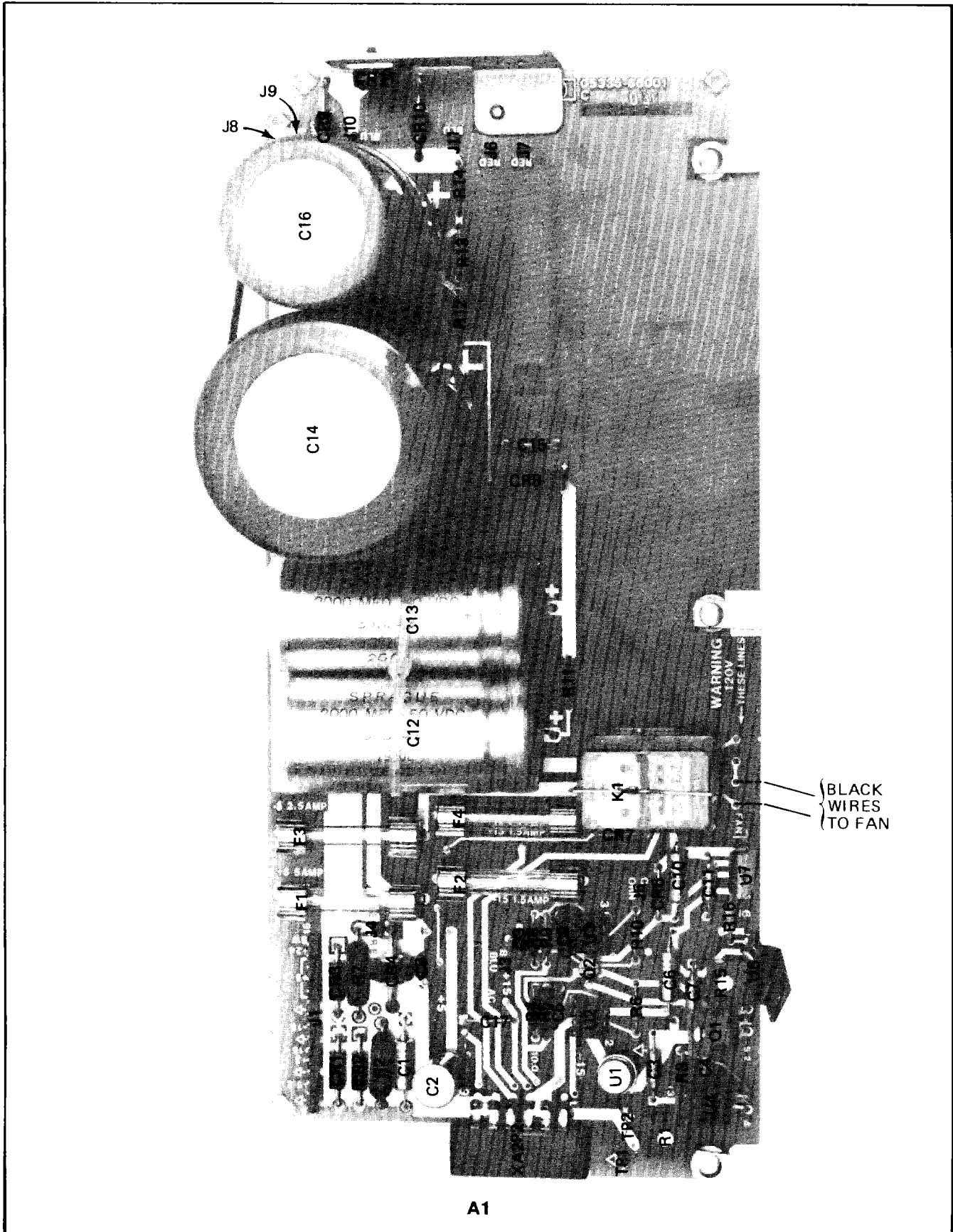

Figure 8-22. Assembly and Cable Locator



A1

Part of Figure 8-23. A1 Power Supply Assembly

A2	A1	
P2(1)	XAR(1)	+5 Volts
(2)	(2)	GROUND
(3)	(3)	GROUND
(4)	(4)	AC DATA Supply
(5)	(5)	GROUND
(6)	(6)	GROUND
(7)	(7)	-5 Volts
(8)	(8)	+10 Volt Reference
(9)	(9)	GROUND
(10)	(10)	AC DATA Supply
(11)	(11)	GROUND
(12)	(12)	-5.2 Volts

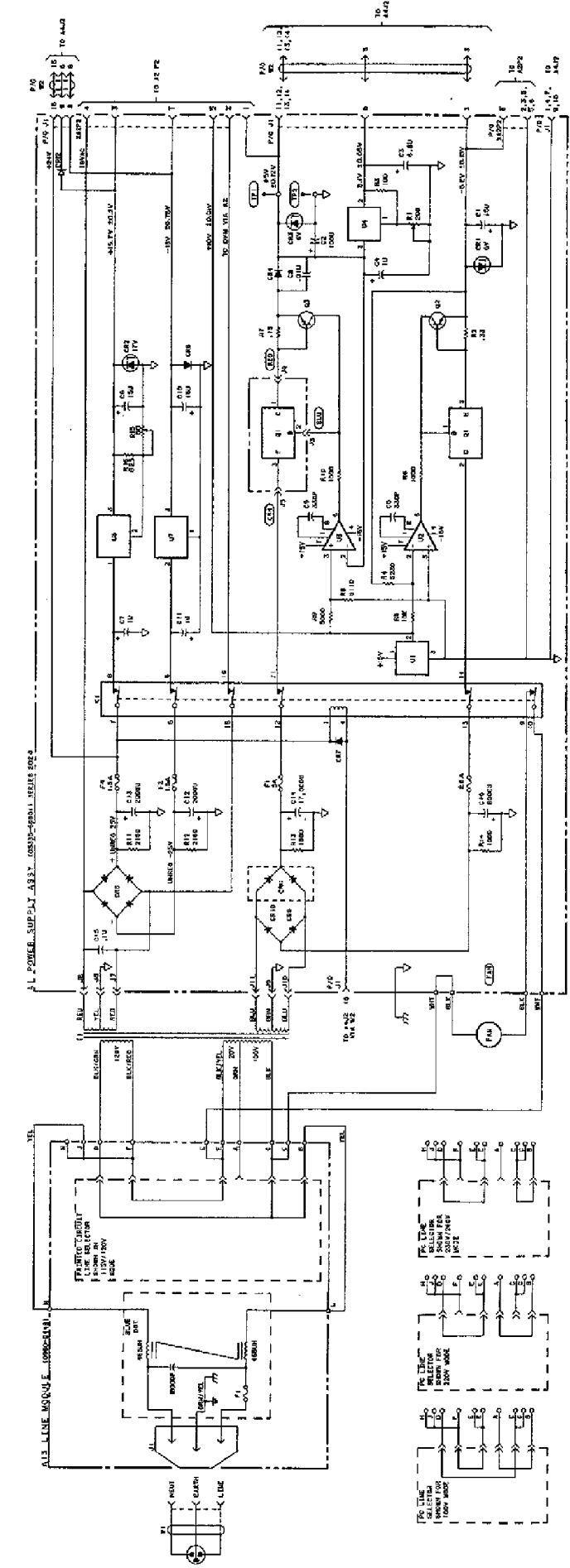

- NOTES:
1. REFERENCE DESIGNATIONS WITH FEET NUMBERS ARE IDENTIFIED, AND DIMENSIONS ARE GIVEN IN INCHES UNLESS OTHERWISE SPECIFIED.
 2. UNLESS OTHERWISE INDICATED, DIMENSIONS IN PARENTHESES ARE FOR FACTORY TOLERANCES.
 3. DIMENSIONS IN PARENTHESES ARE FOR FACTORY TOLERANCES.
 4. DIMENSIONS IN PARENTHESES ARE FOR FACTORY TOLERANCES.
 5. DIMENSIONS IN PARENTHESES ARE FOR FACTORY TOLERANCES.
 6. DIMENSIONS IN PARENTHESES ARE FOR FACTORY TOLERANCES.
 7. DIMENSIONS IN PARENTHESES ARE FOR FACTORY TOLERANCES.
 8. DIMENSIONS IN PARENTHESES ARE FOR FACTORY TOLERANCES.
 9. DIMENSIONS IN PARENTHESES ARE FOR FACTORY TOLERANCES.
 10. DIMENSIONS IN PARENTHESES ARE FOR FACTORY TOLERANCES.

REFERENCE DESIGNATOR	VALUE	DESCRIPTION
R1	10K	RESISTOR
R2	10K	RESISTOR
R3	10K	RESISTOR
R4	10K	RESISTOR
R5	10K	RESISTOR
R6	10K	RESISTOR
R7	10K	RESISTOR
R8	10K	RESISTOR
R9	10K	RESISTOR
R10	10K	RESISTOR
R11	10K	RESISTOR
R12	10K	RESISTOR
R13	10K	RESISTOR
R14	10K	RESISTOR
R15	10K	RESISTOR
R16	10K	RESISTOR
R17	10K	RESISTOR
R18	10K	RESISTOR
R19	10K	RESISTOR
R20	10K	RESISTOR
R21	10K	RESISTOR
R22	10K	RESISTOR
R23	10K	RESISTOR
R24	10K	RESISTOR
R25	10K	RESISTOR
R26	10K	RESISTOR
R27	10K	RESISTOR
R28	10K	RESISTOR
R29	10K	RESISTOR
R30	10K	RESISTOR
R31	10K	RESISTOR
R32	10K	RESISTOR
R33	10K	RESISTOR
R34	10K	RESISTOR
R35	10K	RESISTOR
R36	10K	RESISTOR
R37	10K	RESISTOR
R38	10K	RESISTOR
R39	10K	RESISTOR
R40	10K	RESISTOR
R41	10K	RESISTOR
R42	10K	RESISTOR
R43	10K	RESISTOR
R44	10K	RESISTOR
R45	10K	RESISTOR
R46	10K	RESISTOR
R47	10K	RESISTOR
R48	10K	RESISTOR
R49	10K	RESISTOR
R50	10K	RESISTOR
R51	10K	RESISTOR
R52	10K	RESISTOR
R53	10K	RESISTOR
R54	10K	RESISTOR
R55	10K	RESISTOR
R56	10K	RESISTOR
R57	10K	RESISTOR
R58	10K	RESISTOR
R59	10K	RESISTOR
R60	10K	RESISTOR
R61	10K	RESISTOR
R62	10K	RESISTOR
R63	10K	RESISTOR
R64	10K	RESISTOR
R65	10K	RESISTOR
R66	10K	RESISTOR
R67	10K	RESISTOR
R68	10K	RESISTOR
R69	10K	RESISTOR
R70	10K	RESISTOR
R71	10K	RESISTOR
R72	10K	RESISTOR
R73	10K	RESISTOR
R74	10K	RESISTOR
R75	10K	RESISTOR
R76	10K	RESISTOR
R77	10K	RESISTOR
R78	10K	RESISTOR
R79	10K	RESISTOR
R80	10K	RESISTOR
R81	10K	RESISTOR
R82	10K	RESISTOR
R83	10K	RESISTOR
R84	10K	RESISTOR
R85	10K	RESISTOR
R86	10K	RESISTOR
R87	10K	RESISTOR
R88	10K	RESISTOR
R89	10K	RESISTOR
R90	10K	RESISTOR
R91	10K	RESISTOR
R92	10K	RESISTOR
R93	10K	RESISTOR
R94	10K	RESISTOR
R95	10K	RESISTOR
R96	10K	RESISTOR
R97	10K	RESISTOR
R98	10K	RESISTOR
R99	10K	RESISTOR
R100	10K	RESISTOR

Figure 0-23. A11 Power Supply Assembly and A13 Line Module

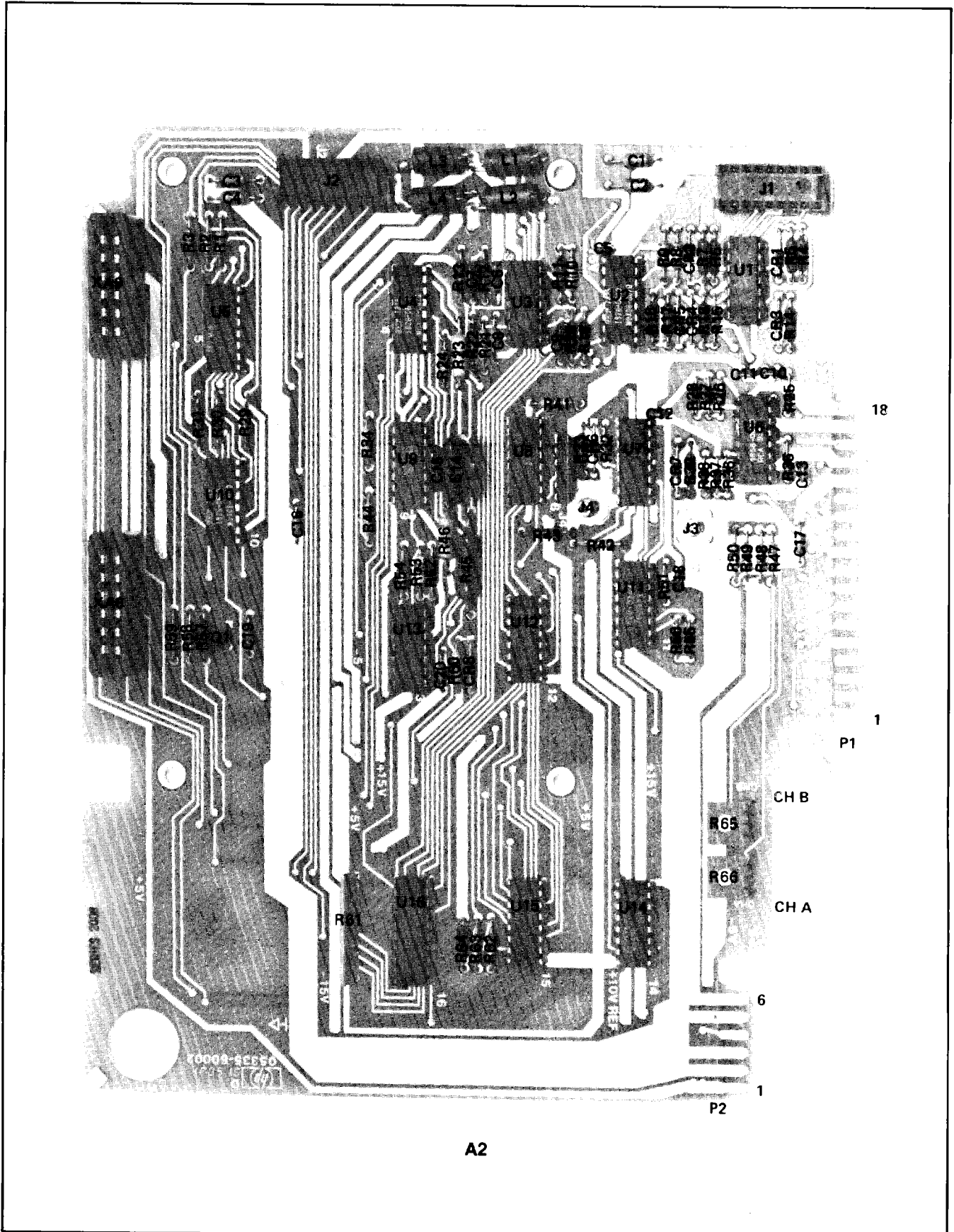

Part of Figure 8-24. A2 Amplifier Support Assembly

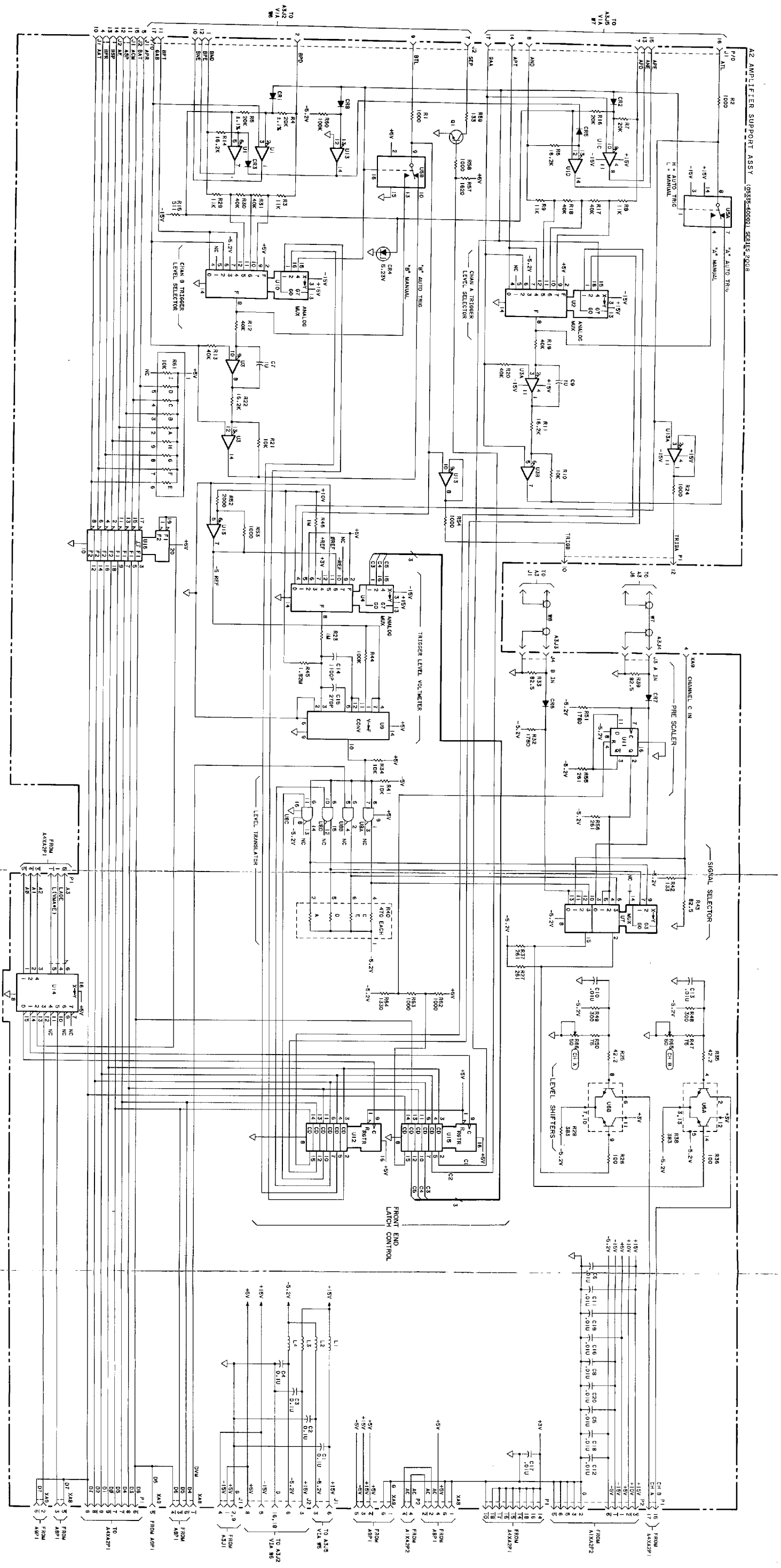

NOTES:

1. REFERENCE DESIGNATIONS WITH THIS ASSEMBLY ARE ARRANGED IN THE ORDER SHOWN IN THIS ASSEMBLY NUMBER TO ABBREVIATION FOR COMPLETE DESCRIPTION.
2. UNLESS OTHERWISE INDICATED, CAPACITANCE IN PICO FARADS.
3. ASTERISK (*) INDICATES FACTORY SELECTED COMPONENT, AVIAGE VALVE FOR COMPLETE DESCRIPTION.

NOTE: REFER TO SECTION VIII, PARAGRAPH 8-27 FOR PROCEDURE TO REPLACE FACTORY SELECTED COMPONENTS.

REFERENCE DESIGNATOR

A2

REFERENCE DESIGNATOR	HP PART DESIGNATION
C1-C20	180-0576
C21-C25	192-3597
C26-C28	182-0216
C29	825-0216
C30	825-0216
C31	825-0216
C32	825-0216
C33	825-0216
C34	825-0216
C35	825-0216
C36	825-0216
C37	825-0216
C38	825-0216
C39	825-0216
C40	825-0216
C41	825-0216
C42	825-0216
C43	825-0216
C44	825-0216
C45	825-0216
C46	825-0216
C47	825-0216
C48	825-0216
C49	825-0216
C50	825-0216
C51	825-0216
C52	825-0216
C53	825-0216
C54	825-0216
C55	825-0216
C56	825-0216
C57	825-0216
C58	825-0216
C59	825-0216
C60	825-0216
C61	825-0216
C62	825-0216
C63	825-0216
C64	825-0216
C65	825-0216
C66	825-0216
C67	825-0216
C68	825-0216
C69	825-0216
C70	825-0216
C71	825-0216
C72	825-0216
C73	825-0216
C74	825-0216
C75	825-0216
C76	825-0216
C77	825-0216
C78	825-0216
C79	825-0216
C80	825-0216
C81	825-0216
C82	825-0216
C83	825-0216
C84	825-0216
C85	825-0216
C86	825-0216
C87	825-0216
C88	825-0216
C89	825-0216
C90	825-0216
C91	825-0216
C92	825-0216
C93	825-0216
C94	825-0216
C95	825-0216
C96	825-0216
C97	825-0216
C98	825-0216
C99	825-0216
C100	825-0216

Figure 8-24. A2 Amplifier Support Assembly

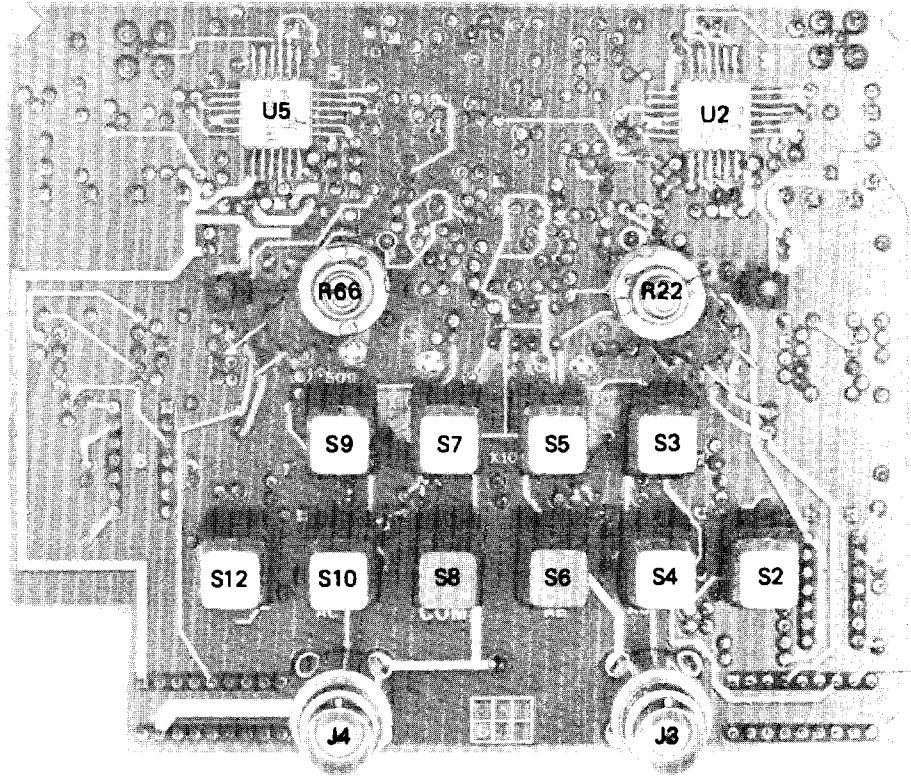

A3 FRONT

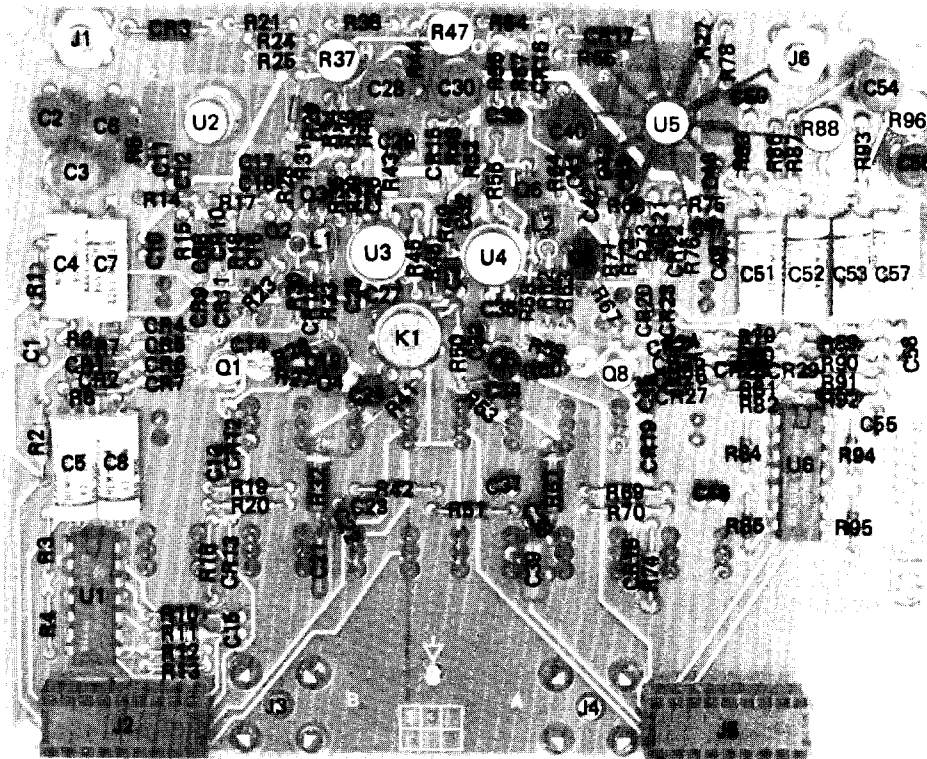

A3 REAR

Part of Figure 8-25. A3 Amplifier Buffer Assembly

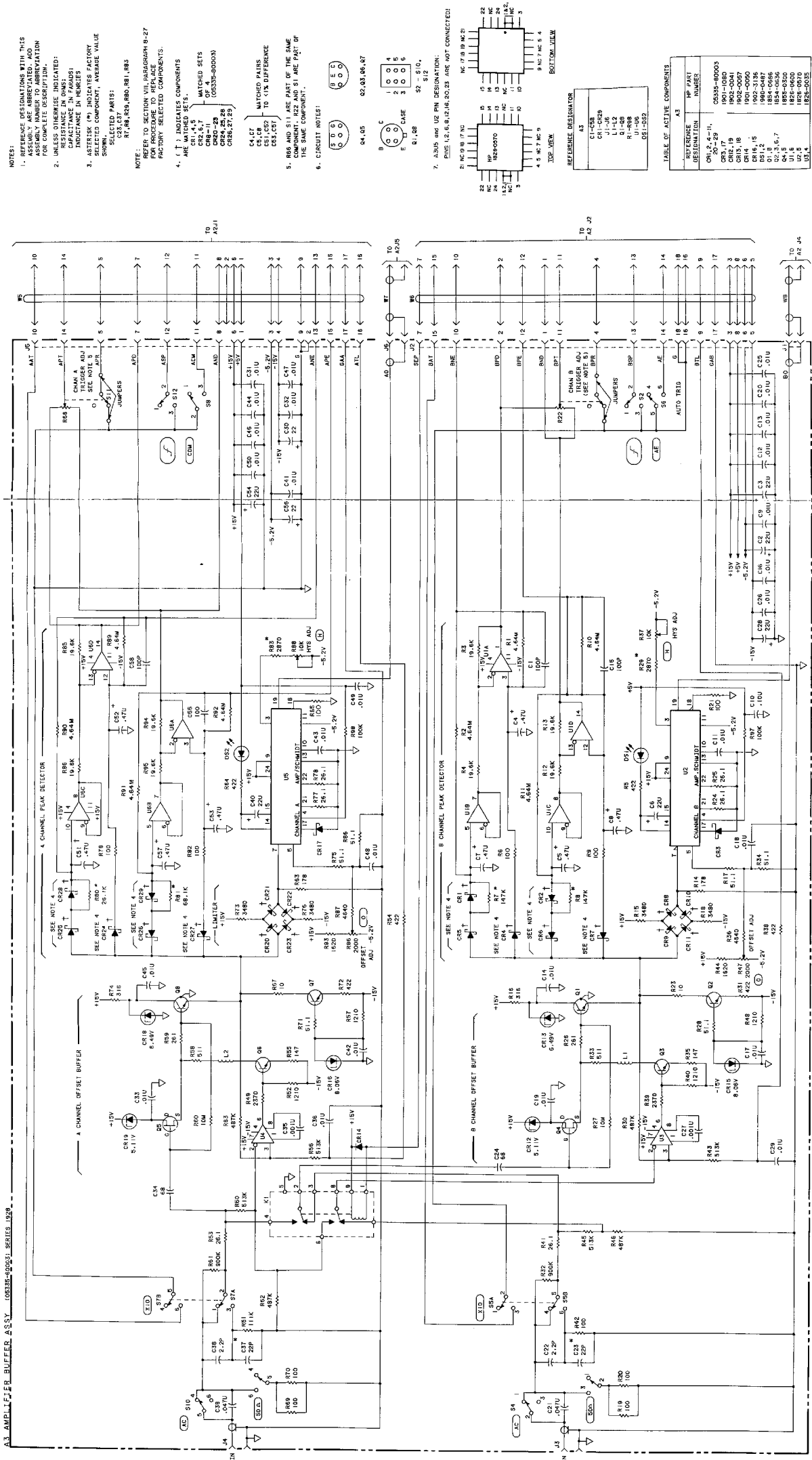

5335A A2 to A3 CONNECTIONS

CONNECTION	MNEMONIC	FUNCTION
J1(1)	A2	+5 Volt Supply
(2)	GND	Ground Return
(3)	-5.2	-5.2 Volt Supply
(4)	-15	-15 Volt Supply
(5)	APR	Ch "A" preset switch status (PRESET/non PRESET = 5V/0V)
(6)	+15	+15 volt supply
(7)	APD	Channel "A" positive peak detector output
(8)	AND	Channel "A" negative peak detector output
(9)	GND	Ground Return
(10)	AAT	Channel "A" Atten. 0V/5V = X10/X1
(11)	ACM	Channel A Common
(12)	ASP	Channel A Slope (/ = 5V/0V)
(13)	ANE	Channel A positive peak detector enable
(14)	APT	Channel A Trigger Level Pot
(15)	APE	Channel A Negative Peak Detector Enable
(16)	ATL	Trigger Level to A Channel
(17)	GAA	Analog Ground A Channel
(18)	N/C	
J2(1)	A3	Channel B negative peak detector output
(2)	BPD	Channel B positive peak detector output
(3)	+15	+15 volt supply
(4)	BPR	Channel B preset switch status (PRESET/non PRESET = 5V/0V)
(5)	-15	-15 volt supply
(6)	-5.2	-5.2 volt supply
(7)	SEP	Common/separate relay (3.5V/15.5V = SEP/COM)
(8)	+5	+5 volt supply
(9)	BTL	Trigger Level to B Channel
(10)	BNE	Channel B positive peak detector enable
(11)	BPT	Channel B Trigger Level Pot
(12)	BPE	Channel B negative peak detector enable
(13)	BSP	Channel B Slope (f / = 5V/0V)
(14)	AE	AUTO TRIG enable (ON/OFF = 0V/5V)
(15)	BAT	Channel "B" Attenuator (0V/5V = X10/X1)
(16)	GND	Ground Return
(17)	GAB	Analog Ground B Channel
(18)	GND	Ground Return

A21 to A3J5 Channel A output
A2J2 to A3J2 Channel B output

Figure 8-25. A3 Amplifier Buffer Assembly 8-73

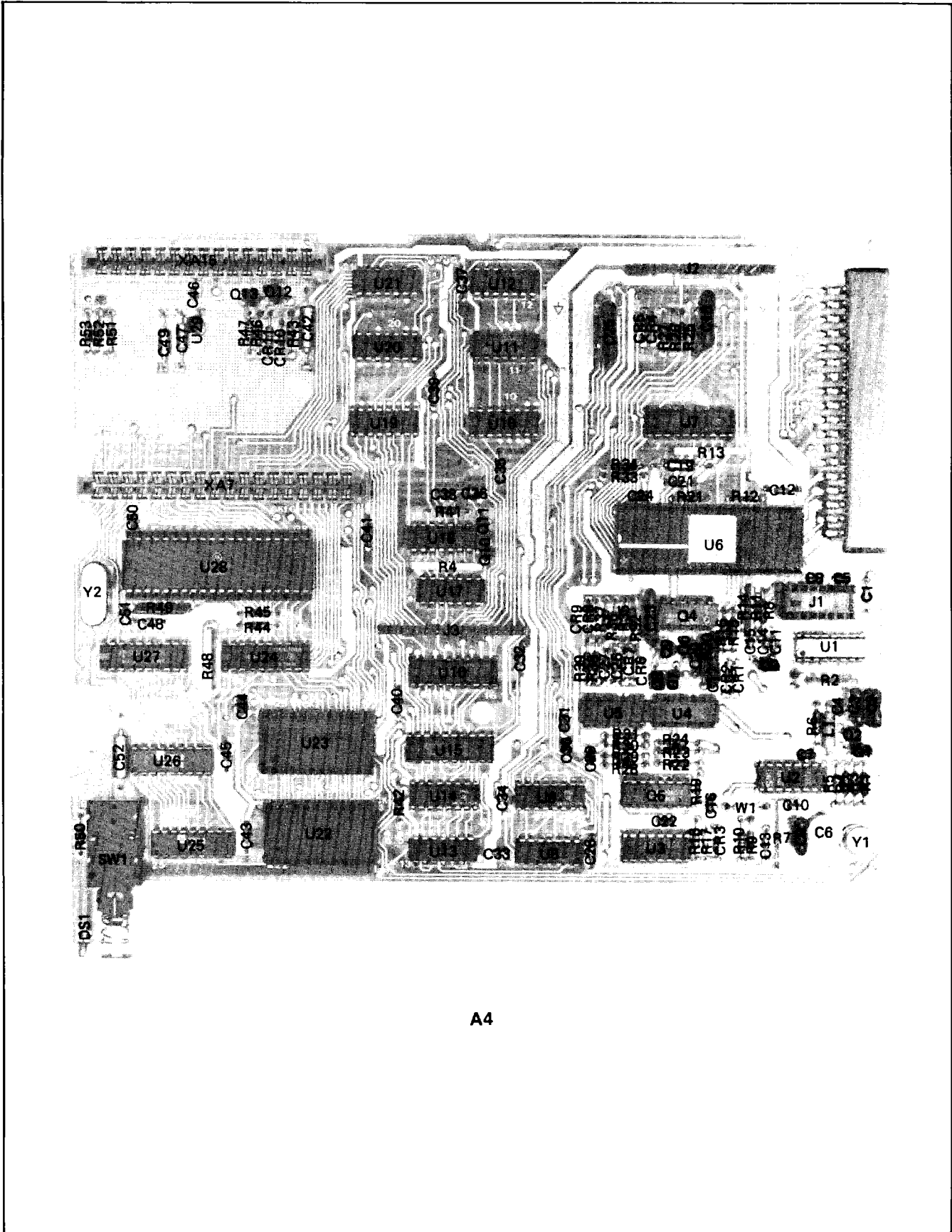

Part of Figure 8-26. A4 Main Logic Assembly

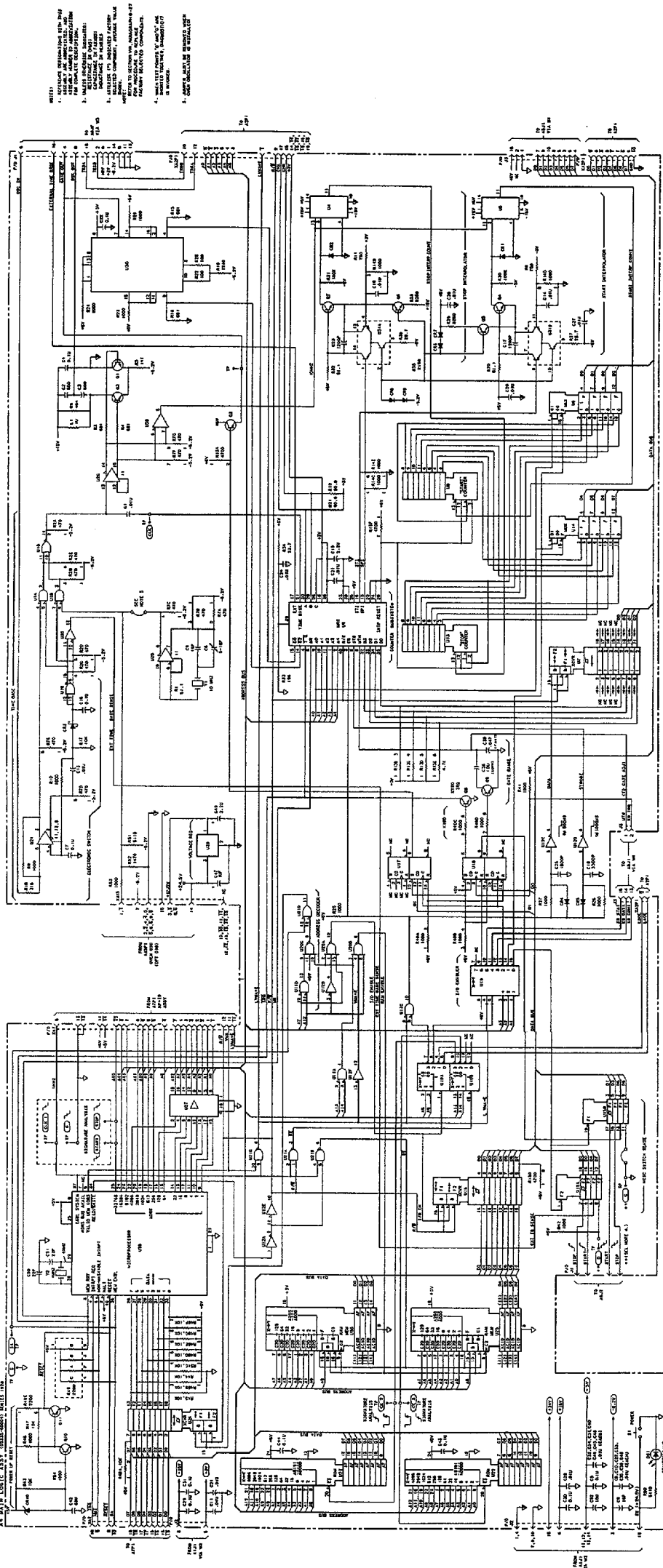

1. ALL WIRING AND CONNECTIONS TO BE MADE IN ACCORDANCE WITH THE WIRING DIAGRAM AND THE WIRING LIST.
 2. ALL WIRING AND CONNECTIONS TO BE MADE IN ACCORDANCE WITH THE WIRING DIAGRAM AND THE WIRING LIST.
 3. ALL WIRING AND CONNECTIONS TO BE MADE IN ACCORDANCE WITH THE WIRING DIAGRAM AND THE WIRING LIST.
 4. ALL WIRING AND CONNECTIONS TO BE MADE IN ACCORDANCE WITH THE WIRING DIAGRAM AND THE WIRING LIST.
 5. ALL WIRING AND CONNECTIONS TO BE MADE IN ACCORDANCE WITH THE WIRING DIAGRAM AND THE WIRING LIST.
 6. ALL WIRING AND CONNECTIONS TO BE MADE IN ACCORDANCE WITH THE WIRING DIAGRAM AND THE WIRING LIST.

5335A CONNECTIONS: A2 to A4

A2	A4
P1 (1)	XAZP(1)
(2)	(2)
(3)	(3)
(4)	(4)
(5)	(5)
(6)	(6)
(7)	(7)
(8)	(8)
(9)	(9)
(10)	(10)
(11)	(11)
(12)	(12)
(13)	(13)
(14)	(14)
(15)	(15)
(16)	(16)
(17)	(17)
(18)	(18)
(19)	(19)
(20)	(20)
(21)	(21)
(22)	(22)
(23)	(23)
(24)	(24)
(25)	(25)
(26)	(26)
(27)	(27)
(28)	(28)
(29)	(29)
(30)	(30)
(31)	(31)
(32)	(32)
(33)	(33)
(34)	(34)
(35)	(35)
(36)	(36)
(37)	(37)
(38)	(38)
(39)	(39)
(40)	(40)
(41)	(41)
(42)	(42)
(43)	(43)
(44)	(44)
(45)	(45)
(46)	(46)
(47)	(47)
(48)	(48)

LAOE
 R/W (not used)
 A3 (not used)
 A4 (not used)
 A3
 D7
 D5
 D3
 D1
 BFL
 NC
 ATL
 NC
 +3 Volts
 CH B to MRC
 +3 Volts
 CH A to MRC
 +3 Volts
 LIVMAE
 LBOE (not used)
 A2
 A1
 A0
 D6
 D4
 D2
 D0
 GROUND
 NC
 NC
 NC
 +3 Volts
 +3 Volts
 +3 Volts
 +3 Volts
 +3 Volts

Figure 8-36. A4 Main Logic Assembly

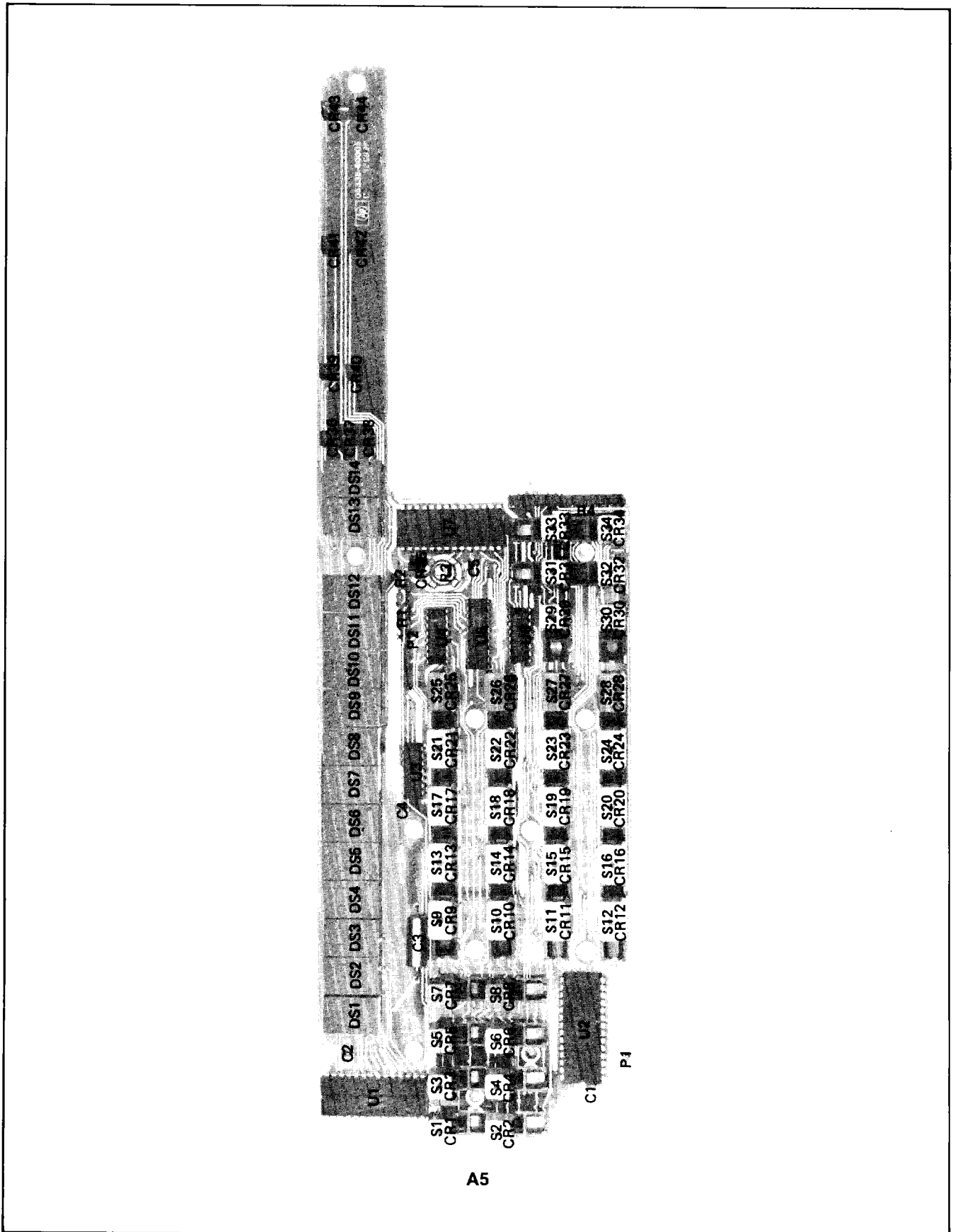

Part of Figure 8-27. A5 Keyboard and Display Assembly

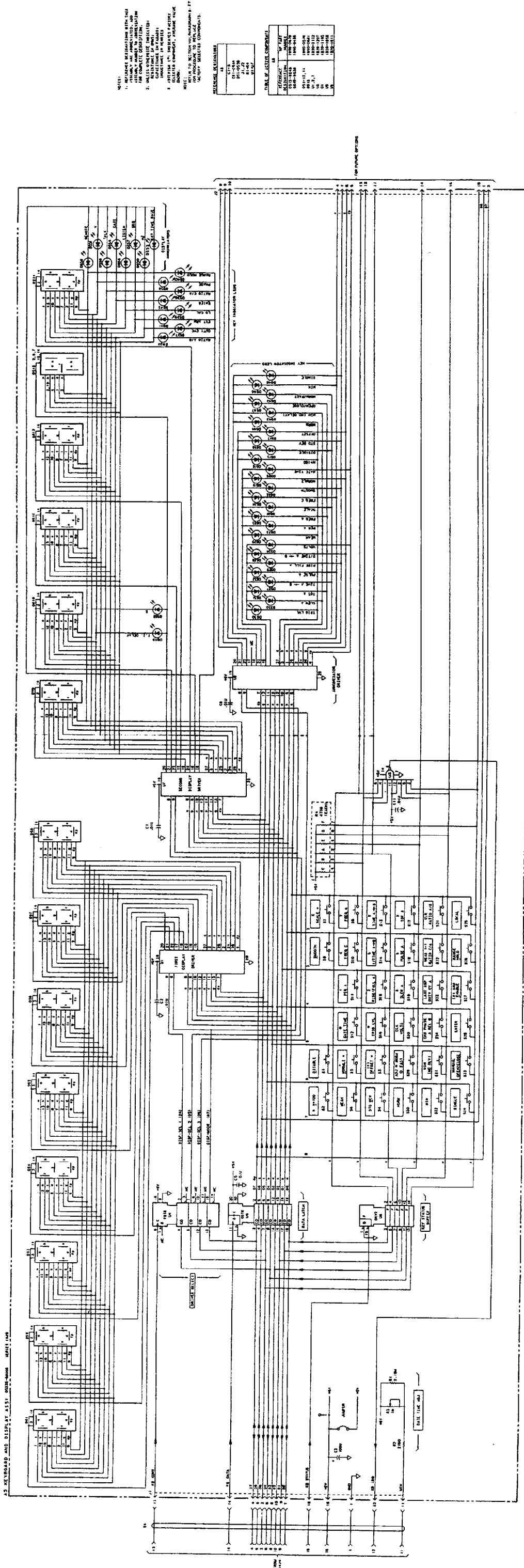

NOTE:
 1. ALL COMPONENTS ARE TO BE INSTALLED IN THE ORDER SHOWN IN THIS DRAWING.
 2. ALL ELECTRICAL CONNECTIONS ARE TO BE MADE IN ACCORDANCE WITH THE INSTRUCTIONS IN PARTS LIST.
 3. ALL ELECTRICAL CONNECTIONS ARE TO BE MADE IN ACCORDANCE WITH THE INSTRUCTIONS IN PARTS LIST.
 4. ALL ELECTRICAL CONNECTIONS ARE TO BE MADE IN ACCORDANCE WITH THE INSTRUCTIONS IN PARTS LIST.
 5. ALL ELECTRICAL CONNECTIONS ARE TO BE MADE IN ACCORDANCE WITH THE INSTRUCTIONS IN PARTS LIST.

TABLE OF LEGAL COMPONENTS

REFERENCE	QUANTITY	DESCRIPTION
1	1	KEYBOARD
2	1	DISPLAY
3	1	RECORD
4	1	DATA LATCH
5	1	RELAY
6	1	RELAY
7	1	RELAY
8	1	RELAY
9	1	RELAY
10	1	RELAY
11	1	RELAY
12	1	RELAY
13	1	RELAY
14	1	RELAY
15	1	RELAY
16	1	RELAY
17	1	RELAY
18	1	RELAY
19	1	RELAY
20	1	RELAY
21	1	RELAY
22	1	RELAY
23	1	RELAY
24	1	RELAY
25	1	RELAY
26	1	RELAY
27	1	RELAY
28	1	RELAY
29	1	RELAY
30	1	RELAY
31	1	RELAY
32	1	RELAY
33	1	RELAY
34	1	RELAY
35	1	RELAY
36	1	RELAY
37	1	RELAY
38	1	RELAY
39	1	RELAY
40	1	RELAY
41	1	RELAY
42	1	RELAY
43	1	RELAY
44	1	RELAY
45	1	RELAY
46	1	RELAY
47	1	RELAY
48	1	RELAY
49	1	RELAY
50	1	RELAY
51	1	RELAY
52	1	RELAY
53	1	RELAY
54	1	RELAY
55	1	RELAY
56	1	RELAY
57	1	RELAY
58	1	RELAY
59	1	RELAY
60	1	RELAY
61	1	RELAY
62	1	RELAY
63	1	RELAY
64	1	RELAY
65	1	RELAY
66	1	RELAY
67	1	RELAY
68	1	RELAY
69	1	RELAY
70	1	RELAY
71	1	RELAY
72	1	RELAY
73	1	RELAY
74	1	RELAY
75	1	RELAY
76	1	RELAY
77	1	RELAY
78	1	RELAY
79	1	RELAY
80	1	RELAY
81	1	RELAY
82	1	RELAY
83	1	RELAY
84	1	RELAY
85	1	RELAY
86	1	RELAY
87	1	RELAY
88	1	RELAY
89	1	RELAY
90	1	RELAY
91	1	RELAY
92	1	RELAY
93	1	RELAY
94	1	RELAY
95	1	RELAY
96	1	RELAY
97	1	RELAY
98	1	RELAY
99	1	RELAY
100	1	RELAY

Figure 8-27. AS Keyboard and Display Assembly
 8-77

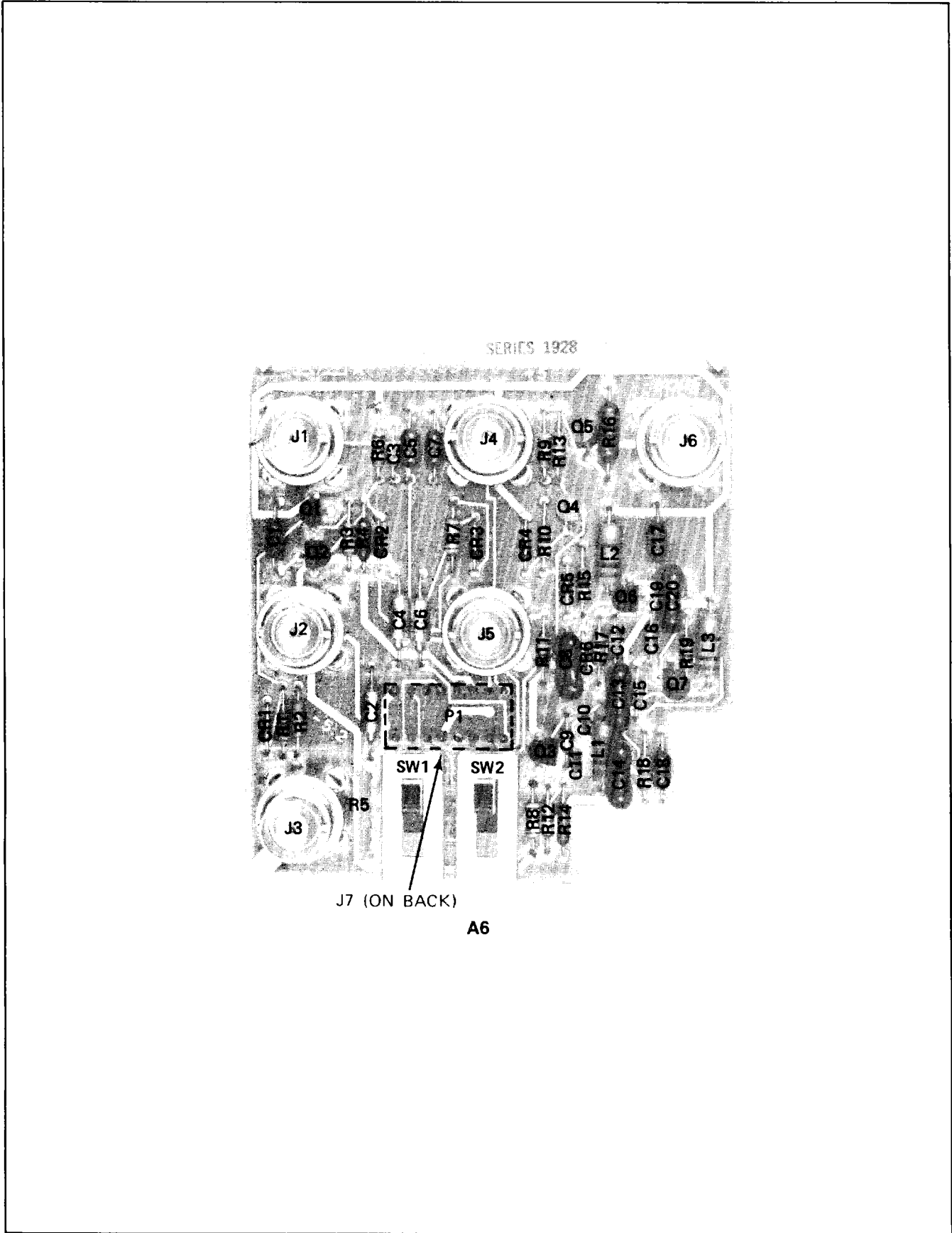

Part of Figure 8-28. A6 Rear Panel Assembly

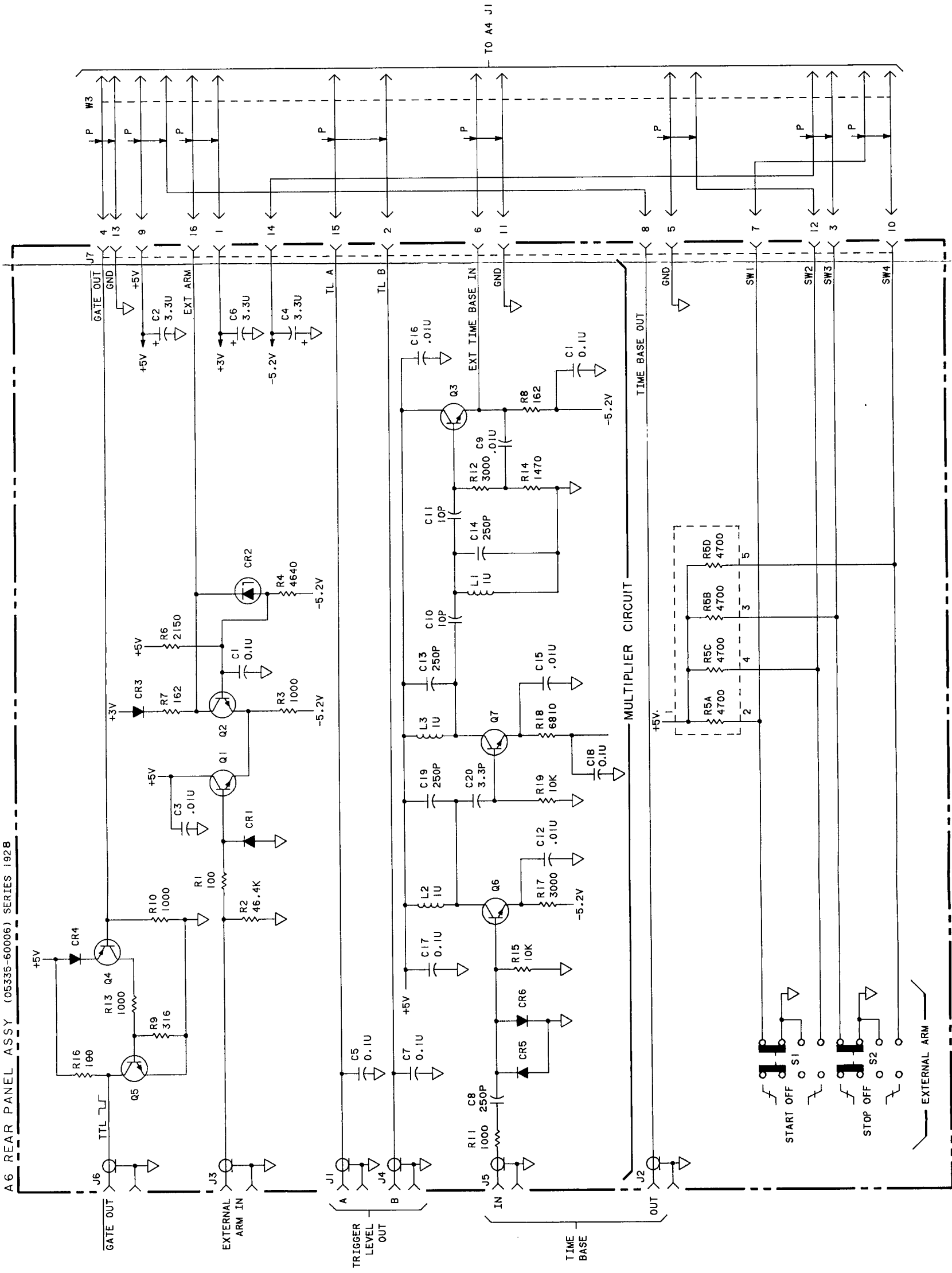

NOTES:

1. REFERENCE DESIGNATIONS WITH THIS ASSEMBLY ARE ABBREVIATED. ADD ASSEMBLY NUMBER TO ABBREVIATION FOR COMPLETE DESCRIPTION.
2. UNLESS OTHERWISE INDICATED: RESISTANCE IN OHMS; CAPACITANCE IN FARADS; INDUCTANCE IN HENRIES
3. ASTERISK (*) INDICATES FACTORY SELECTED COMPONENT, AVERAGE VALUE SHOWN.

NOTE:
REFER TO SECTION VIII, PARAGRAPH 8-27 FOR PROCEDURE TO REPLACE FACTORY SELECTED COMPONENTS.

REFERENCE DESIGNATOR

A6
C1-C20
CR1-CR8
J1-J7
L1-L3
R1-R19
S1, S2
Q1-Q7

TABLE OF ACTIVE COMPONENTS

REFERENCE DESIGNATION	HP PART NUMBER
A6	
CR1-3, 5, 6, 8	1901-0050
CR4, 7	1901-0535
Q1-3, 5-7	1854-0215
Q4	1853-0036

Figure 8-28. A6 Rear Panel Assembly

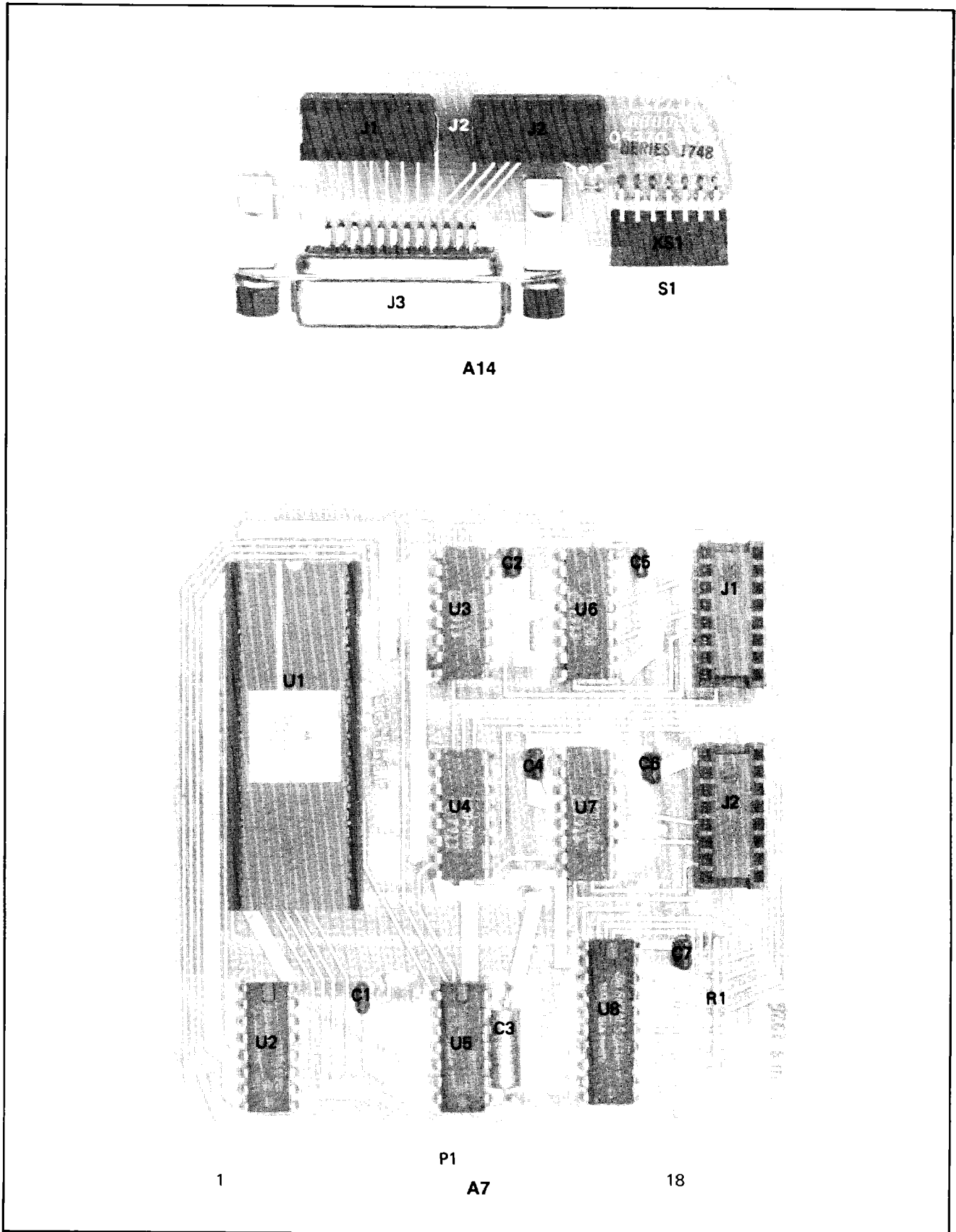

Part of Figure 8-29. A7 HP-IB Logic Assembly and A14 HP-IB Connector Assembly

A2	A8
A2XA8(1)	A8P1(1)
(2)	(2)
(3)	(3)
(4)	(4)
(5)	(5)
(6)	(6)
(1)	(1)
(2)	(2)
(3)	(3)
(4)	(4)
(5)	(5)
(6)	(6)

DIAG	PIN 16	PIN 1
20 (-5V)	0	0
21 (GND)	0	1
22 (+5V)	1	0
23, 24 & 25	1	1

TP2 DVM V-F +5V ≈ 11.325 KHz - DIAG 22
 -5V ≈ 900 Hz - DIAG 20
 0V ≈ 6.1 KHz - DIAG 21

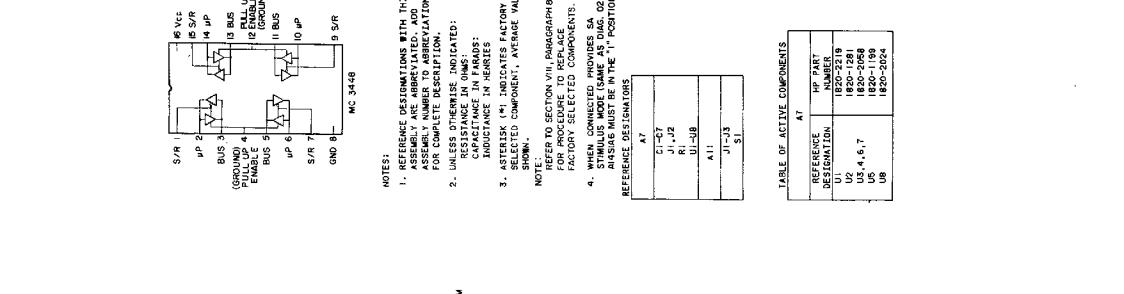
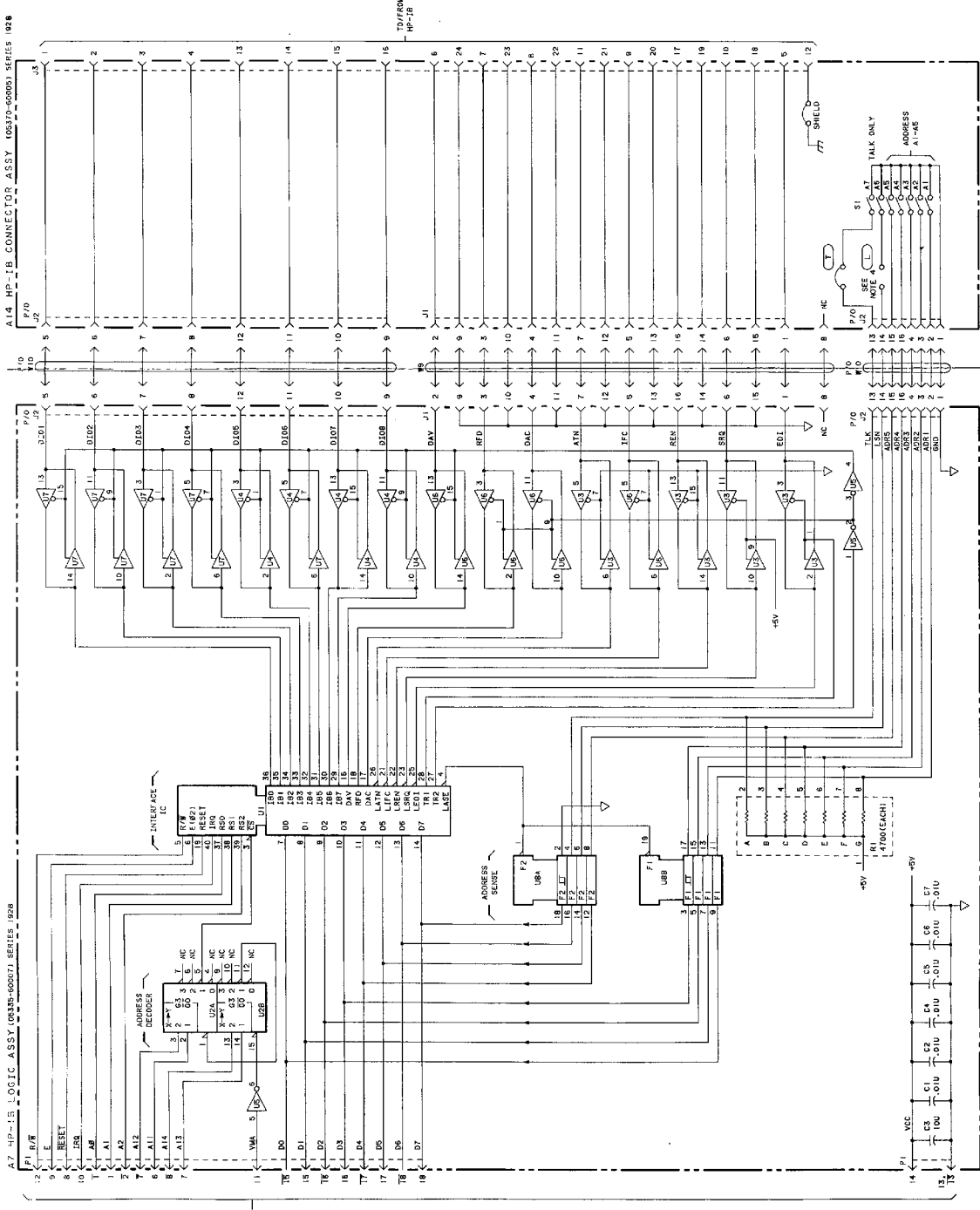

NOTES:
 1. REFERENCE DESIGNATIONS WITH THIS ASSEMBLY ARE ABBREVIATED. ADD THE REFERENCE DESIGNATION FOR COMPLETE DESCRIPTION.
 2. UNLESS OTHERWISE INDICATED: RESISTANCE IN OHMS; CAPACITANCE IN PICO FARADS; DIMENSIONS IN INCHES.
 3. ASTERISK (*) INDICATES FACTORY SELECTED COMPONENT. AVERAGE VALUE.
 NOTE: REFER TO SECTION VII, PARAGRAPHS 2-7 FOR FACTORY SELECTED COMPONENTS.
 4. WHEN CONNECTED PROVIDES 5A. BUSHING MUST BE IN THE "I" POSITION.

REFERENCE DESIGNATION	HP PART NUMBER
U1	1820-2219
U2	1820-1291
U3	1820-1199
U4	1820-2024

Figure 8-29. A7 HP-IB Logic Assembly and A14 HP-IB Connector Assembly

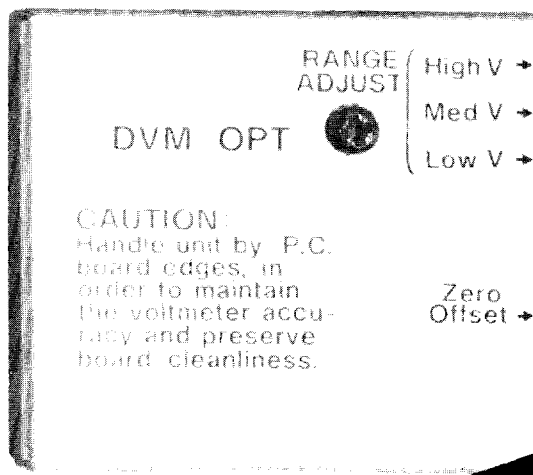

COVER REMOVED FOR SERVICING
(Rotated 90° Clockwise for Viewing)

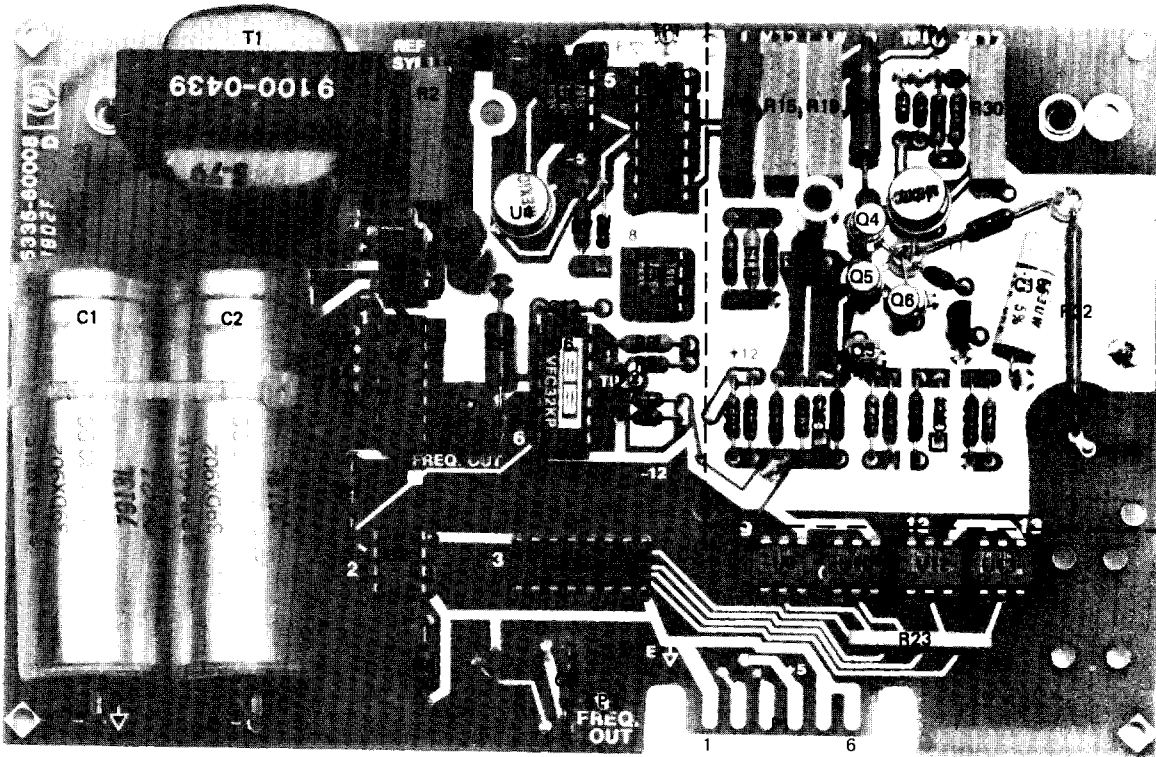

A8

Part of Figure 8-30. A8 DVM Assembly

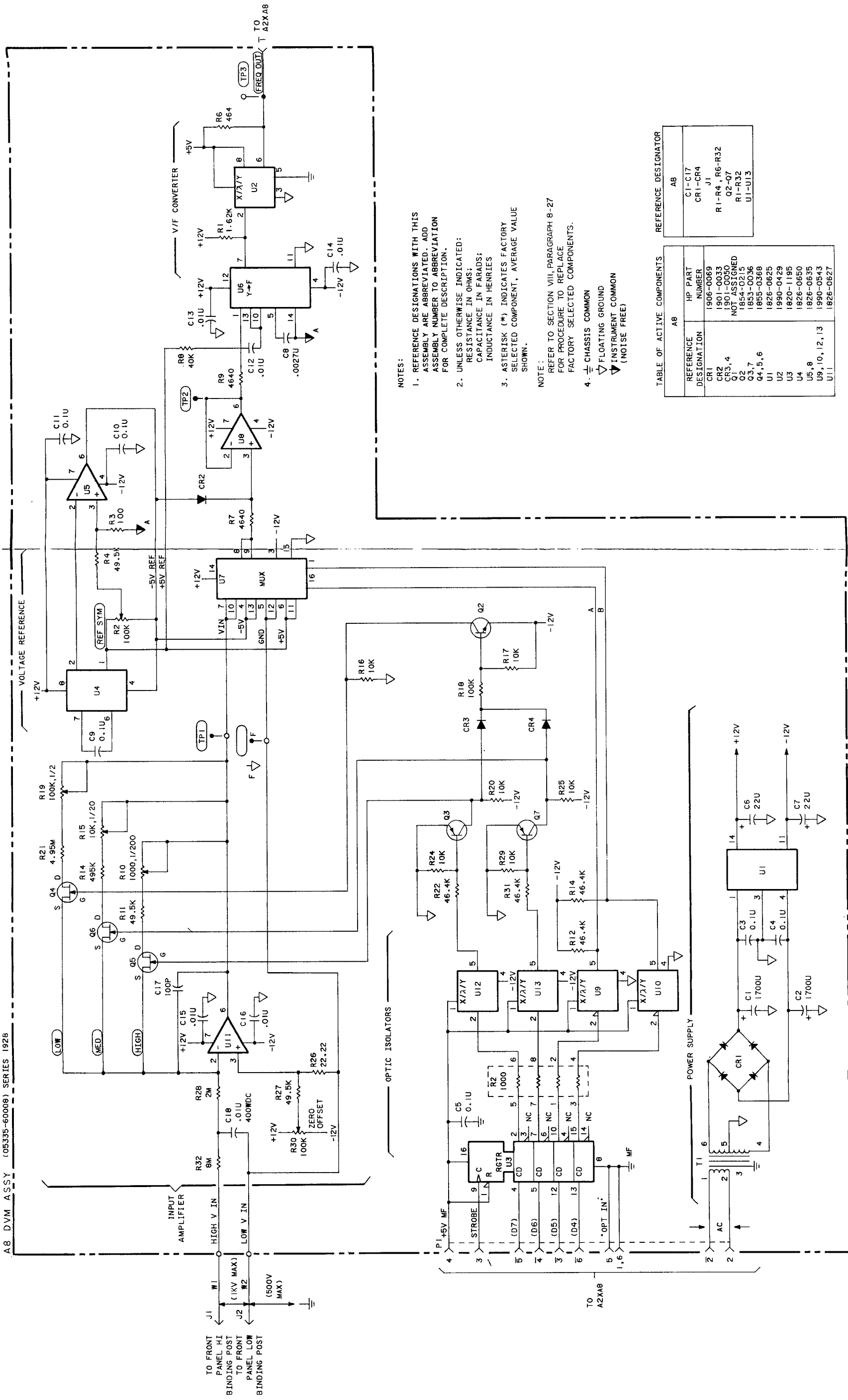

NOTES:

1. REFERENCE DESIGNATIONS WITH THIS ASSEMBLY ARE ABBREVIATED. ADD ASSEMBLY NUMBER TO ABBREVIATION FOR COMPLETE DESCRIPTION.
2. UNLESS OTHERWISE INDICATED: RESISTANCE IN OHMS; CAPACITANCE IN FARADS; INDUCTANCE IN HENRIES
3. ASTERISK (*) INDICATES FACTORY SELECTED COMPONENT, AVERAGE VALUE SHOWN.
- NOTE: REFER TO SECTION VIII, PARAGRAPH 8-27 FOR PROCEDURE TO REPLACE FACTORY SELECTED COMPONENTS.
4. \square CHASSIS COMMON
 ∇ FLOATING GROUND
 \blacktriangledown INSTRUMENT COMMON (NOISE FREE)

TABLE OF ACTIVE COMPONENTS

REFERENCE DESIGNATION	HP PART NUMBER	REFERENCE DESIGNATOR
CR1	1906-0069	A8
CR2	1901-0033	C1-C17
CR3, 4	1901-0050	CR1-CR4
O1	NOT ASSIGNED	J1
Q2	1854-0215	R1-R4, R6-R32
Q3, 7	1853-0036	Q2-Q7
Q4, 5, 6	1855-0368	R1-R32
U1	1826-0625	U1-U13
U2	1826-0625	
U3	1826-0625	
U4	1820-1195	
U5, 8	1826-0650	
U9, 10, 12, 13	1826-0635	
U11	1990-0543	
	1826-0627	

Figure 8-30. A8 DVM Assembly

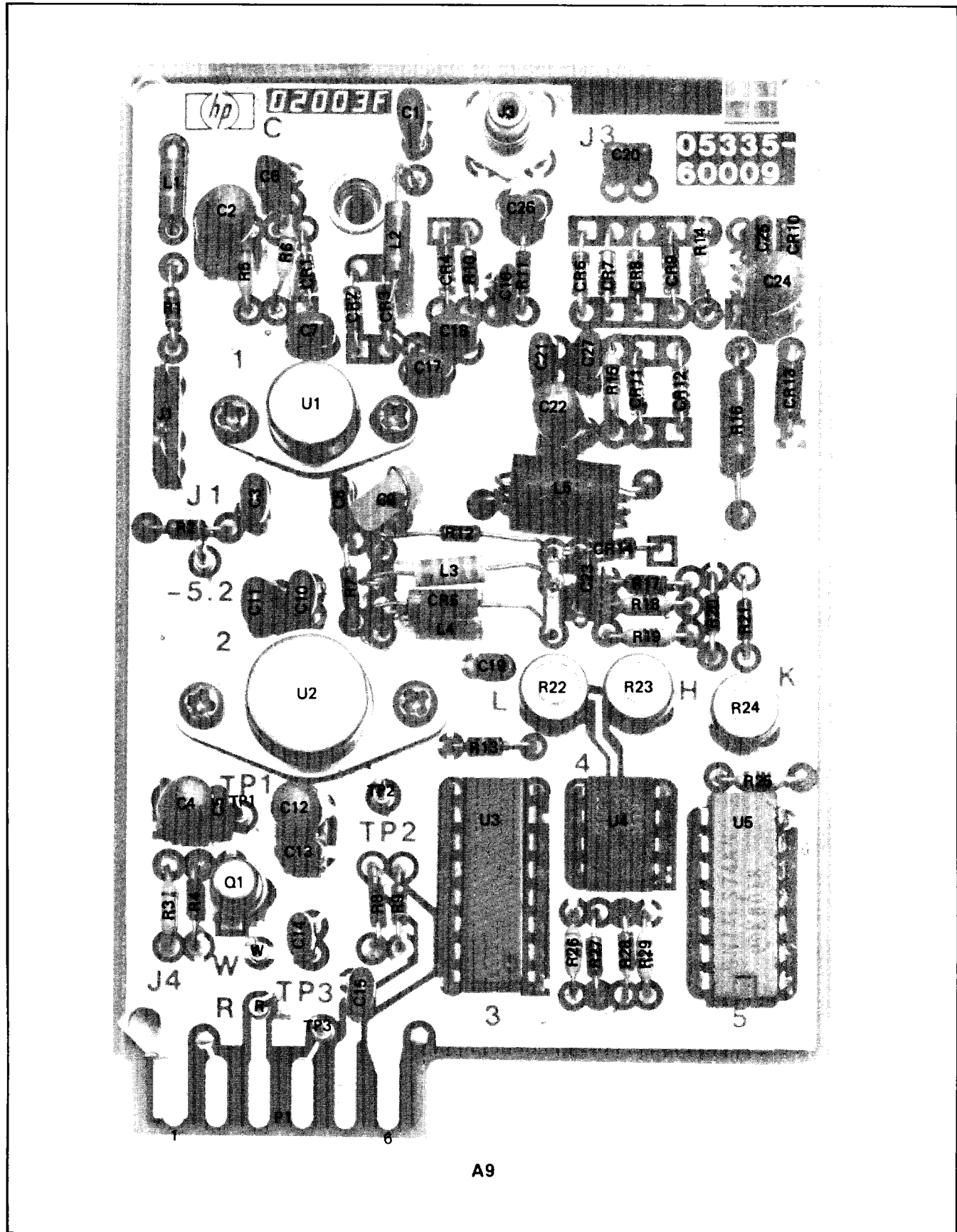

Part of Figure 8-31. A9 Channel C Assembly

S35 CONNECTIONS A2 TO A9	
A2-A9 (same pins)	A9(1)
(1)	GROUND
(2)	ENABLE
(3)	+15 Volts
(4)	Channel "C" Output
(5)	-5.2 Volts
(6)	GROUND
(7)	NC
(8)	NC
(9)	+5 Volts
(10)	D6
(11)	D7

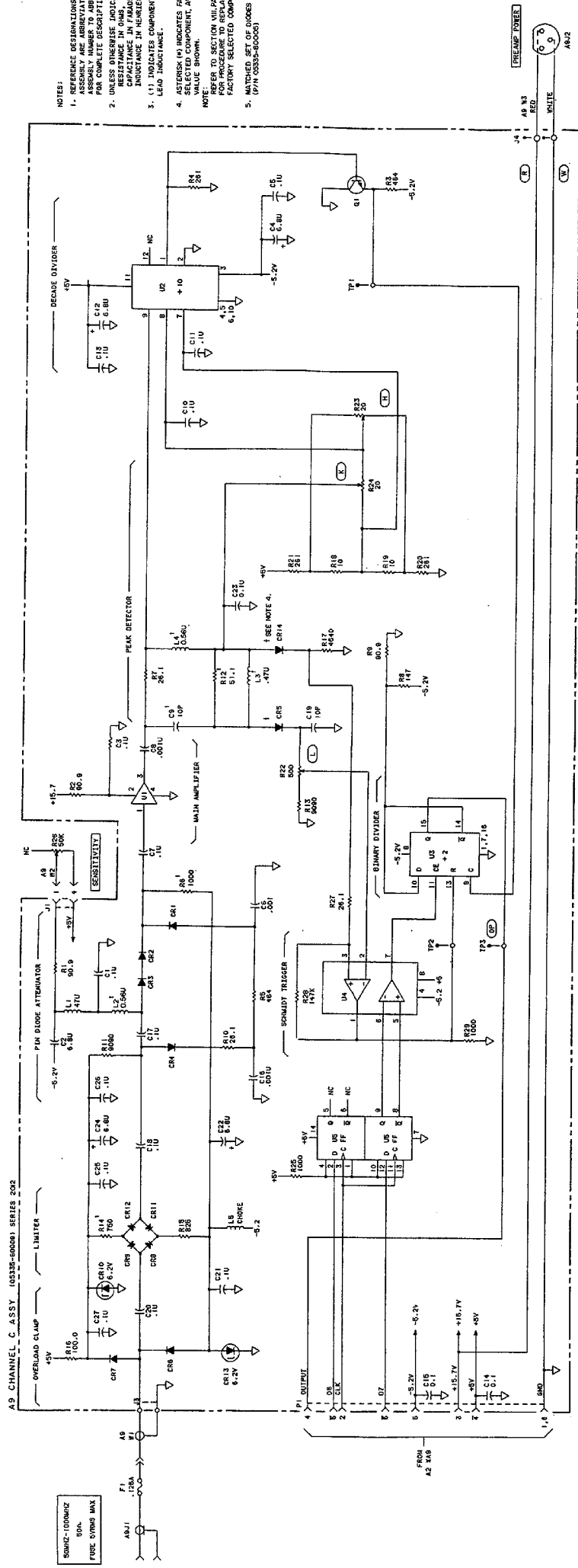

- NOTES:
1. REFERENCE DESIGNATIONS WITHIN THIS ASSEMBLY ARE ABBREVIATED. A LISTING OF THE COMPLETE DESCRIPTION, PART NUMBER, RESISTANCE IN OHMS, CAPACITANCE IN MICROFARADS, INDUCTANCE IN HENRIES, AND LEAD INDICATOR IS SHOWN IN SECTION VIII, PARAGRAPH 8-27 FOR PROCEDURE TO REPLACE FACTORY SELECTED COMPONENTS.
 2. UNLESS OTHERWISE INDICATED, RESISTANCE IN OHMS, CAPACITANCE IN MICROFARADS, INDUCTANCE IN HENRIES, AND LEAD INDICATOR IS SHOWN IN SECTION VIII, PARAGRAPH 8-27 FOR PROCEDURE TO REPLACE FACTORY SELECTED COMPONENTS.
 3. LEAD INDICATOR IS SHOWN IN SECTION VIII, PARAGRAPH 8-27 FOR PROCEDURE TO REPLACE FACTORY SELECTED COMPONENTS.
 4. ASTERISK (*) INDICATES FACTORY VALUE SHOWN.
 5. MATCHED SET OF DIODES (M7N 6003-6004)

Figure 8-31. A9 Channel C Assembly 8-45

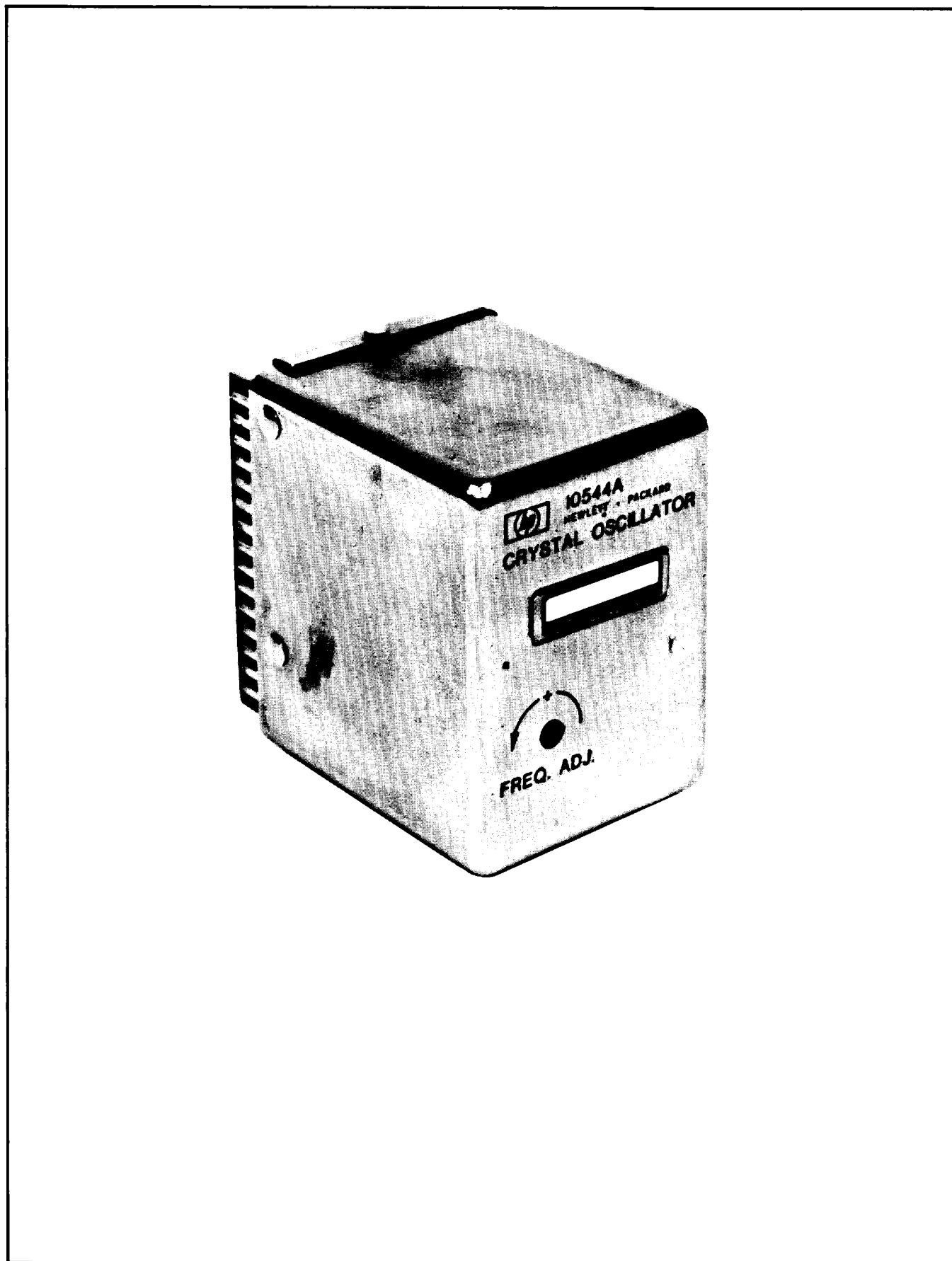

Part of Figure 8-32. A15 10 MHz Oscillator (Model 10544A) Option 010

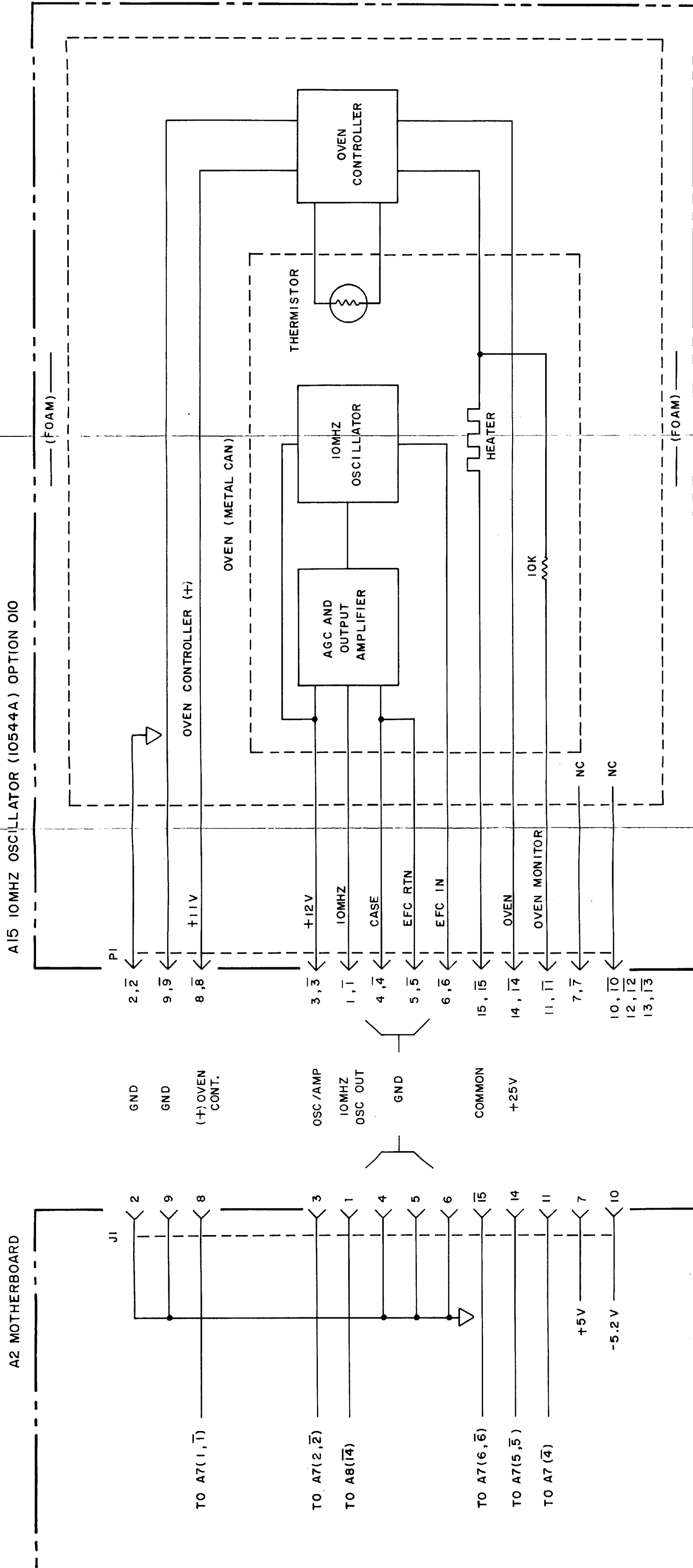

Figure 8-32. A15 10 MHz Oscillator (Model 10544A) Option 010
8-87

